



RHINO METALS[™]
PROTECTING & SECURING AMERICA

SWING OUT GUN RACK INSTRUCTIONS

TABLE OF CONTENTS

6-Gun Swing Out Rack (SOR6)	3
13-Gun Swing Out Rack (SOR13)	5
13-Gun Swing Out Rack (SOR13) for SafeX®	7
Sheetrock Clearance Instructions	9
Gun Safe Installation Instructions (SOR6)	10
Gun Safe Installation Instructions (SOR13)	11
Limited Warranty	13

Visit rhinosafe.com for the current listing of approved safe models that are Swing Out Rack compatible.

U.S. Patent 9,140,049

WARNING: Installation of this product on any other model or brand (list of approved models on rhinosafe.com) is NOT APPROVED and is solely at the consumers risk. Installation of this product on non-approved models or brands may adversely affect or eliminate any manufacturers warranty, affect the operation of the product it is installed on and may create tipping hazards which could cause injury or death. Rhino Metals is not responsible for any claims arising out of the installation or attempted installation of this product on non-approved products.

6-Gun Swing Out Rack Parts List

Hardware may be black or zinc

1 EVA Foam Insert (x3)

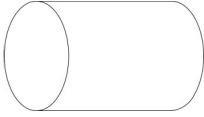

4 Hinge (x2)

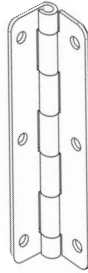

7 Frame SOR6 (x1)

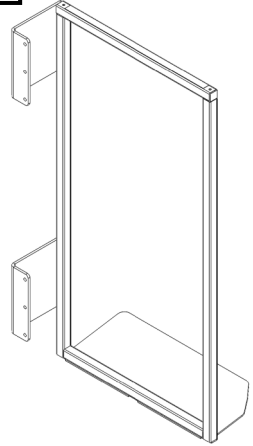

2 Mini M6 Screw (x3)



5 M6-1mm x 16mm Screw (x12)

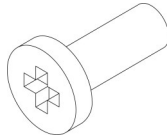

3 M6-1mm Nylock Nut (x12)

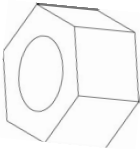

6 Top Foam Barrel Rest (x1)

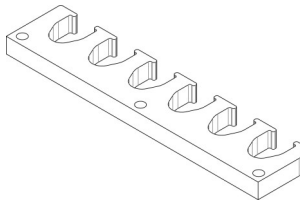

8 Foam Butt Rest (x1)

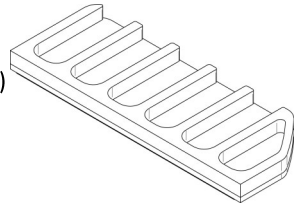

Ensure all parts are dust free before installation

Tools required for install:

- Phillips head screwdriver
- 10mm open end wrench or socket wrench



Parts included but not used:

- 12mm washer (x15)

Assemble as Shown

See pages 9 and 10 for gun safe installation

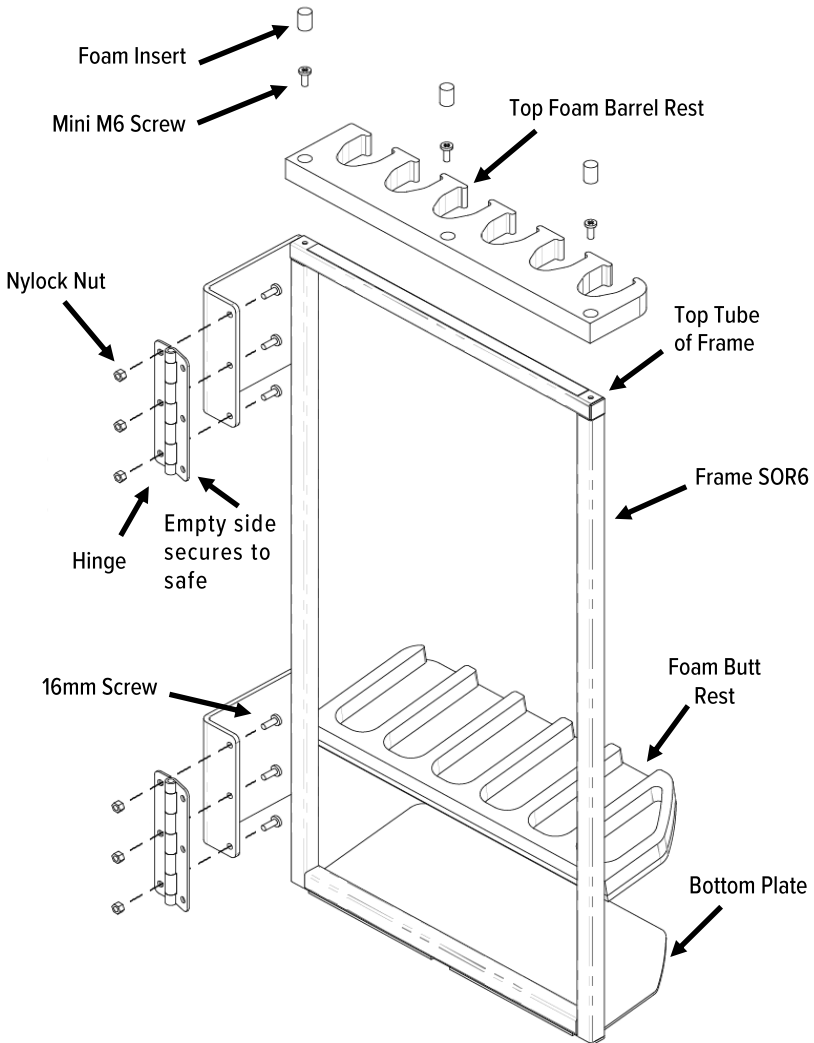

⚠ WARNING ⚠

Tipping of unit can cause serious injury or death.

- Safe must be anchored to floor prior to use, as instructed in the owner's manual
- Do not pull on door with door open unless unit is properly anchored to floor
- Unit is less stable with door open, unless anchored to the floor
- Install on level ground
- Keep children away



13-Gun Swing Out Rack Parts List

If you have a SafeX® Model, see page 7

Hardware may be black or zinc

1 EVA Foam Insert (x3)



6 #10 x 0.5in Screw (x2)

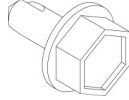

10 Steel Bottom Plate (x1)



2 M6-1mm x 16mm Screw (x6)

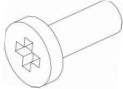

3 M6-1mm x 20mm Screw (x12)

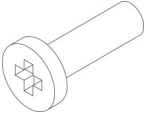

7 Foam Butt Rest A (x1)

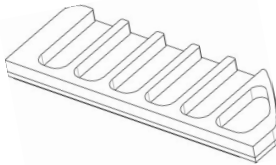

11 Frame SOR13 (x1)

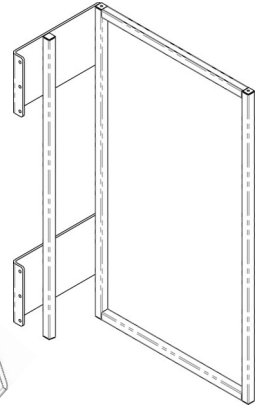

4 Hinge (x2)

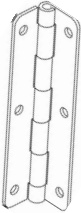

8 Foam Butt Rest B (x1)

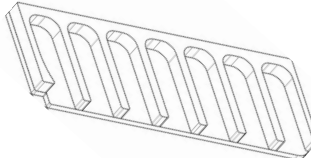

5 M6-1mm Nylock Nut (x12)

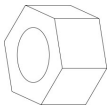

9 Top Foam Barrel Rest (x1)

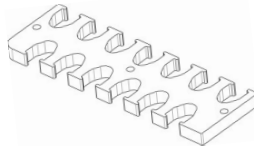

Ensure all parts are dust free before installation

Tools required for install:

- Phillips head screwdriver
- 10mm open end wrench or socket wrench
- Power drill and 10mm x 0.5" socket



Parts included but not used:

- 12mm washer (x12)
- M-6-1mm x 30mm Screw (x6)
- Spacer (x2)
- Hex key (x1)

13-Gun Swing Out Rack Parts List for SafeX® Models

Hardware may be black or zinc

1 EVA Foam Insert (x3)

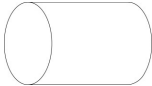

6 M6-1mm Nylock Nut (x12)

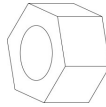

2 M6-1mm x 16mm Screw (x6)

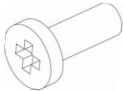

7 M-6-1mm x 20mm Screw (x6)*
(not pictured in assembly; used for safe installation)

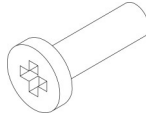

11 Top Foam Barrel Rest (x1)

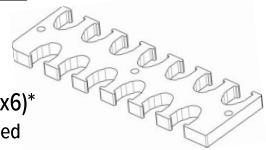

3 M-6-1mm x 30mm Screw (x6)

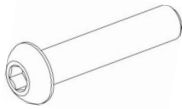

12 Steel Bottom Plate (x1)

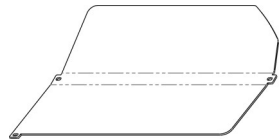

4 Spacer (x2)



8 #10 x 0.5in Screw (x2)



13 Frame SOR13 (x1)

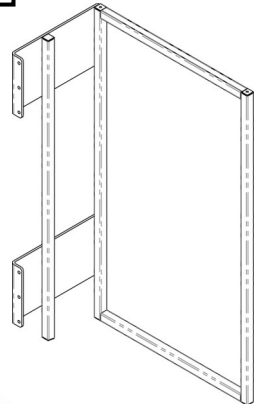

9 Foam Butt Rest A (x1)

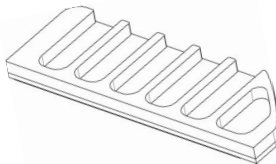

5 Hinge (x2)

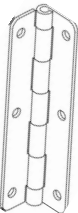

10 Foam Butt Rest B (x1)

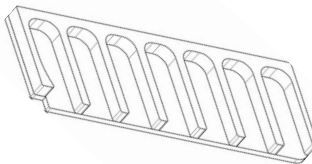

Ensure all parts are dust free before installation

Tools required for install:

- Phillips head screwdriver
- 10mm open end wrench or socket wrench
- Power drill and 10mm x 0.5" socket
- 5/32" hex key

Parts included but not used:

- 12mm washer
- 20mm (x6) *total of 12 pcs; 6 not used



Assemble as Shown for SafeX® Models

See pages 9 and 11 for gun safe installation

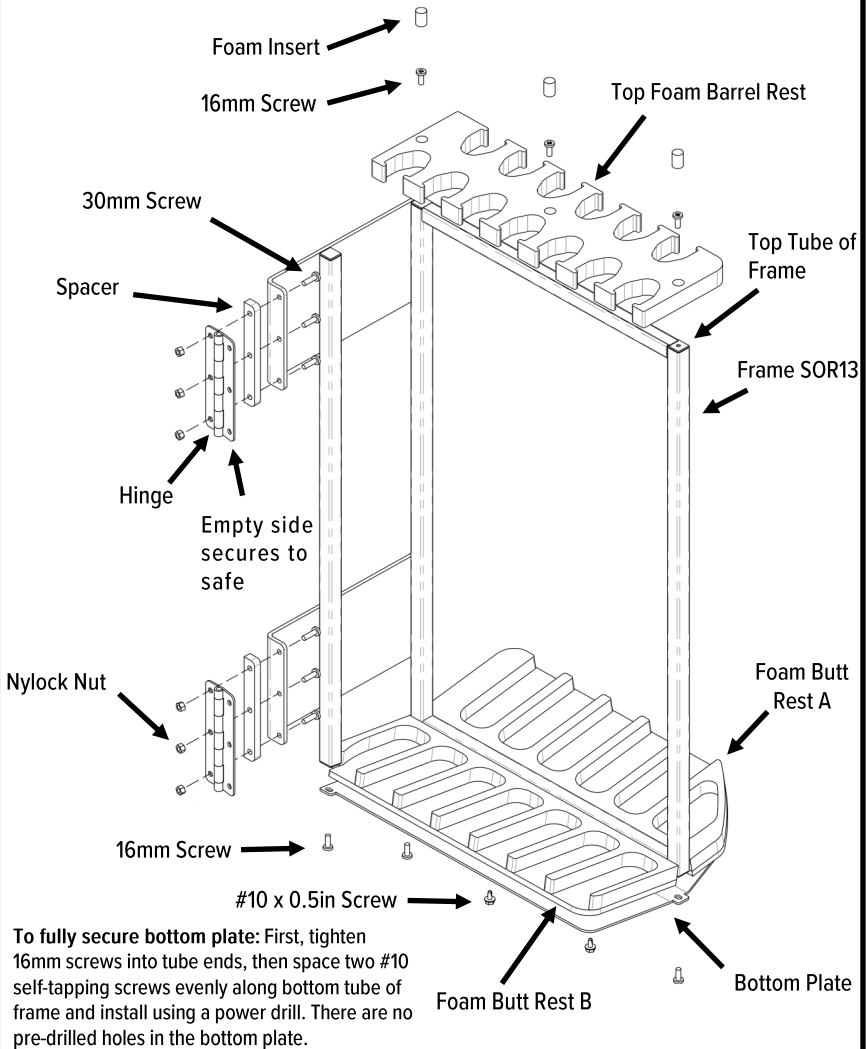

⚠ WARNING ⚠

Tipping of unit can cause serious injury or death.

- Safe must be anchored to floor prior to use, as instructed in the owner's manual
- Do not pull on door with door open unless unit is properly anchored to floor
- Unit is less stable with door open, unless anchored to the floor
- Install on level ground
- Keep children away



Sheetrock Clearance Instructions

Note: Depending on your safe model, it may already have clearance cuts for your Swing Out Rack and no further modifications are required. Please check before proceeding. If so, refer to page 8 for installation.

To install your new Swing Out Rack, the six holes on the left side of your safe's door opening must have enough sheetrock cut away from behind them. Please follow these steps for checking the sheetrock clearance and to cut away sheetrock as necessary.

1. Using a ruler and tape measure, check if there is at least 1.25 inches of clearance to the sheet rock above the first hole, then below the third hole on the top set of holes. Do this same process for the bottom set of holes. Refer to the diagram on Figure 1.
2. If the sheetrock clearance is less than 1.25 inches, use the tape measure/ ruler and a box cutter to cut away excess sheet rock.

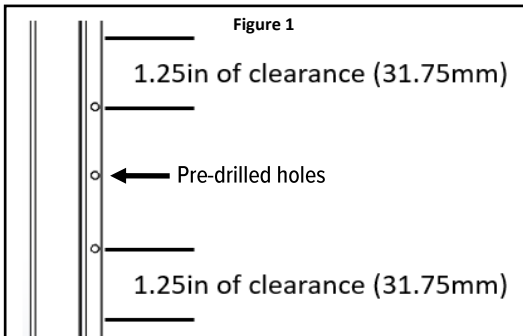

Gun Safe Installation Instructions—SOR6

READ INSTRUCTIONS CAREFULLY FOR PROPER INSTALLATION BASED ON SAFE MODEL

Note: 2 people are recommended for the following steps. If installing alone, use a rolled up towel, blanket, or piece of foam to set the Swing Out Rack on while inside your safe. Failure to do so can cause damage to the safe or Swing Out Rack, or cause personal injury.

1. Align the top hinge with the top 3 pre-drilled holes on the safe door flange. Ensure the hinge curls are facing inside and the hinge is behind the flange as shown in Figure 2.
2. Use three 16mm Screws (#5) and three Nylock Nuts (#3) to attach hinge to door flange.
3. Repeat for bottom section.

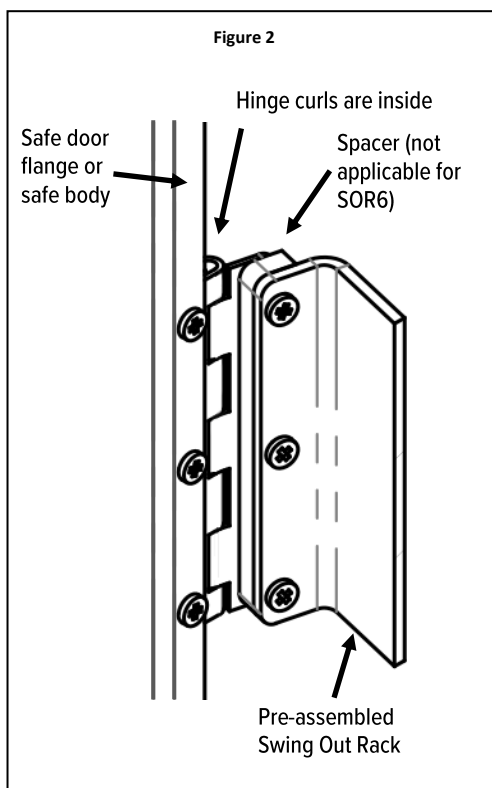

Do not exceed the weight rating of 100lbs for the Swing-Out Rack. Rhino Metals is not liable for damage caused by improper installation of Swing Out Rack

Gun Safe Installation Instructions—SOR13

READ INSTRUCTIONS CAREFULLY FOR PROPER INSTALLATION BASED ON SAFE MODEL

Note: 2 people are recommended for the following steps. If installing alone, use a rolled up towel, blanket, or piece of foam to set the Swing Out Rack on while inside your safe. Failure to do so can cause damage to the safe or Swing Out Rack, or cause personal injury.

SOR13 Safe Install:

1. Align the top hinge with the top three pre-drilled holes on the safe door flange. Ensure the hinge curls are facing inside and the hinge is behind the flange as shown in Figure 3.
2. Use three 20mm Screws (#3) and three Nylock Nuts (#5) to attach hinge to door flange.
3. Repeat for bottom section.

SOR13 on SafeX® Models Install:

1. Align the top hinge with the top three pre-drilled holes on the safe door flange. Ensure the hinge curls are facing inside and the hinge is behind the flange as shown in Figure 3.
2. Use three 20mm Screws (#7) and three Nylock Nuts (#6) to attach hinge to door flange.
3. Repeat for bottom section.

Do not exceed the weight rating of 100lbs for the Swing-Out Rack. Rhino Metals is not liable for damage caused by improper installation of Swing Out Rack

Gun Safe Installation Instructions—SOR13

Figure 3

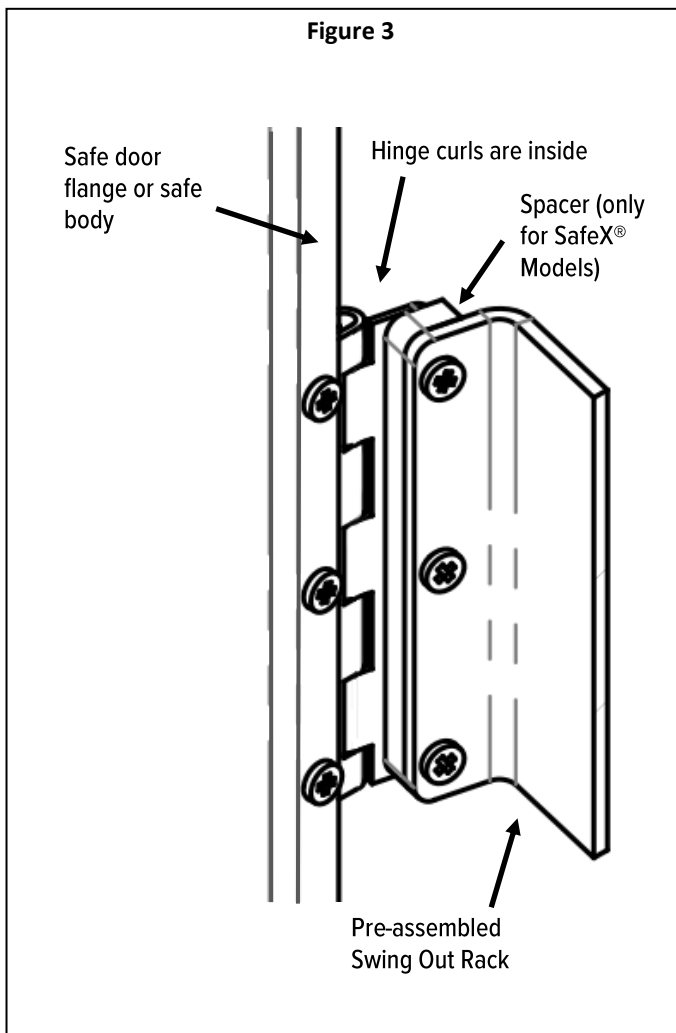

Do not exceed the weight rating of 100lbs for the Swing-Out Rack. Rhino Metals is not liable for damage caused by improper installation of Swing Out Rack

LIMITED WARRANTY (Accessories)

Rhino Metals, Inc. ("Company") warrants to the original consumer ("Purchaser") a Limited Warranty ("Warranty") covering defects in workmanship and material. Warranty is for a period of one (1) year from the date of original purchase and is not assignable or transferable to any other person.

1. Any damage to the product as a result of destruction, misuse, tampering, abuse, neglect, accident, improper installation, modification, unauthorized service or violation of the instructions furnished by Company will void Warranty.
2. The sole responsibility of Company shall be limited to the repair or replacement (in its sole discretion) of any component of the product which fails to conform to Warranty at no cost to Purchaser for a period of one (1) year from the date of the original purchase.
3. Contact Company directly to obtain service under Warranty. A Return Authorization must first be obtained prior to returning defective products to Company.
4. Products shipped without prior Return Authorization may not be accepted. Company will not be responsible for their disposition and/or cost of return to Purchaser.
5. Company will not assume any responsibility for any loss or damage incurred in shipping. All returned products should include a copy of the original invoice or proof of purchase for Warranty to be honored.
6. Warranty is not an insurance policy, and Company is not responsible for damage or theft of Purchaser's product or its contents.
7. Any implied warranties with Purchaser may have a limit to the duration of the warranties described above. There are no further warranties which extend or apply beyond the face hereof, and Company expressly disclaims and excludes all warranties of merchantability or fitness for a particular purpose. Some states do not allow limitation on how long an implied Warranty lasts, so the above limitation may not apply to Purchaser.
8. Repair or replacement shall be the sole remedy for Purchaser under Warranty. Company shall not be liable for any direct, indirect, incidental or consequential damages, losses or expense arising from the use or misuse of the product. Some states do not allow the exclusion, limitation, incidental, or consequential damages so the limitation may not apply to Purchaser.
9. Warranty gives Purchaser specific legal rights, and Purchaser may also have other rights which may vary from state to state.

Warranty is given in place of all other warranties and assurances, whether expressed or implied, including but not limited to matters of merchantability, quality, or fitness for purpose. Company accepts no liability under any circumstances whatsoever, for any incidental or consequential damage or loss suffered by anyone as a result of using or being unable to use the product.