



KA551 – KA558

Alivio Lift Chair Range Instruction Manual

Version: Jan 2024



Table of Contents

Important Safety Instructions.....	3
------------------------------------	---

Warranty.....	4
---------------	---

Assembly of your Lift Chair

Cord and Transformer Connections.....	6
---------------------------------------	---

Chair Assembly.....	7
---------------------	---

Operating Your Lift Chair.....	8
--------------------------------	---

Installing Back-Up Batteries.....	9
-----------------------------------	---

Lithium-Ion Battery Pack Back-Up System.....	10
--	----

Troubleshooting.....	11
----------------------	----

NOTE: When placing the furniture on non-carpeted flooring, K Care Healthcare Solutions recommend the use of floor protection such as an area rug or furniture pads. Area rugs and padding not included with purchase.

K Care Healthcare Solutions recommends stain resistant treatment before use.

NOTE: This device complies with part 15 of the FCC rules. Operation is subject to the following two conditions: (1) this device may not cause interference, and (2) this device must accept any interference, including interference that may cause undesired operation of the device. Modifications not approved by the party responsible for compliance could void user's authority to operate the equipment.

Important Safety Instructions

READ ALL INSTRUCTIONS BEFORE USING.

WARNING: To reduce the risk of burns, fire, electric shock, or injury to persons:

DANGER: To reduce the risk of electric shock, always unplug this furnishing from the electrical outlet before cleaning.

Unplug from outlet before putting on or taking off parts.

Close supervision is necessary when used by (or near) children and disabled people.

Use this furnishing only for its intended use (as described in these instructions). Do not use attachments not recommended by the manufacturer.

Never operate this furnishing if it has a damaged cord or plug, if it is not working properly, if it has been dropped/damaged, or dropped into water.

Keep the cord away from heated surfaces.

Never drop or insert any object into any opening.

Do not use outdoors. Just for household, indoor use only.

Do not operate where aerosol (spray) products are being used, or where oxygen is being administered.

To disconnect, turn all controls to the off position, then remove plug from outlet.

WARNING: Risk of injury - keep children away from extended foot support.

WARNING: Risk of injury to persons - do not use this furnishing to support video equipment, such as televisions or computer monitors.

When not in use, it is recommended the wand be stored securely in the pocket on the outside of the arm.

SAVE THESE INSTRUCTIONS

SERVICING OF DOUBLE-INSULATED PRODUCTS:

In a double-insulated product, two systems of insulation are provided instead of grounding. No grounding means is provided on a double-insulated product, nor is a means for grounding to be added to the product. Servicing a double-insulated product requires extreme care and knowledge of the system, and is to be done only by qualified service personnel. Replacement parts for a double-insulated product must be identical to the parts they replace.

WARRANTY

WARRANTY AGAINST DEFECTS IN GOODS

PRODUCT PART	WARRANTY PERIOD
Steel Frame	Five (5) Years
Motor	Five (5) Years
Electronics	Two (2) Years
Handset & Cable	Two (2) Years
Scissor Mechanisms	Three (3) Years
Steel Lift Mechanism	Three (3) Years
Fabric	Two (2) Years

1. K Care Healthcare Solutions provides consumers with the following warranty in relation to this Product, in addition to complying with the requirements of any relevant legislation, including the Competition and Consumer Act 2010 (Cth) in Australia and the Consumer Guarantees Act 1993 in New Zealand (the **Acts**), except where a New Zealand consumer acquires the Product for the purposes of a business. The benefits to the consumer given by this warranty are in addition to other rights and remedies of the consumer under the applicable Act.
2. In this warranty, we have used the following definitions:
 - (a) **Form** means a Warranty Claim Form issued by K Care Healthcare Solutions in respect of Products.
 - (b) **K Care Healthcare Solutions** or our means K Care Healthcare Solutions Pty Ltd, ABN 47 159 431 099 of 836A Fifteenth Street, Mildura, VIC, 3500.
 - (c) **Product** means this Picasso, Leonardo, Michelangelo or Donatello lift chair manufactured by K Care Healthcare Solutions (including where manufactured by its contract manufacturers);
 - (d) **Material** means a material or component used by K Care Healthcare Solutions in the manufacture of the Product;
 - (e) **Retailer** means the authorised dealer of Products from whom the Product was purchased;
 - (f) **Warranty Period** means the period within which a defect must appear as set out in the table above, commencing from the date of purchase of the relevant Product. If the Product or part (as the case may be) is repaired or replaced, there will be no extension to the original warranty period; and
 - (g) **Workmanship** means the handling, assembly and manufacturing processes performed by or on behalf of K Care Healthcare Solutions in order to manufacture the Product.
3. K Care Healthcare Solutions warrants that for the duration of the Warranty Period, all Products will be free

of faults arising from defects in Workmanship or Materials, on the terms and conditions set out in this warranty.

4. K Care Healthcare Solutions undertakes that if during the Warranty Period any Product, or any part of a Product, has failed to operate correctly due to faulty Workmanship or defective Material, it will repair or replace the Product or part (as the case may be) free of charge (excluding freight fees if applicable) provided that the following procedure is met:
 - (a) The consumer must contact the Retailer or K Care Healthcare Solutions upon becoming aware of any defect to a Product. The consumer will then be provided with a Form, which must be completed by the consumer and returned to K Care Healthcare Solutions at the address, facsimile number or email address stated below together with satisfactory proof of purchase.
 - (b) K Care Healthcare Solutions will review the completed Form to determine whether there is a defect, and if so K Care Healthcare Solutions agrees to (at its option) repair, replace or supply equivalent goods, or pay the cost of any of those remedies to the consumer. To the extent that the issue raised on the completed Form relates to the fabric, K Care Healthcare Solutions will conduct an evaluation of the fabric before determining whether there is a defect.
 - (c) If K Care Healthcare Solutions requests the return of the applicable Product or part, the consumer will be responsible for the collection and freight costs of returning that Product or part to K Care Healthcare Solutions.
 - (d) The consumer acknowledges that it is also responsible for the freight costs to deliver any new Product or replacement part to it.
5. To the extent that the supply of Products is a supply to a consumer within the meaning of the applicable Act, the consumer is entitled to consumer guarantees under the applicable Act which K Care Healthcare Solutions does not exclude, restrict or modify. In all other respects, and to the extent permitted by law, K Care Healthcare Solutions:
 - (a) Limits its liability for any non-excludable condition or warranty to rectifying any defect at its option, as set out in paragraph 4(b); and
 - (b) Excludes liability (whether express or implied) of any nature whatsoever for any consequential loss, damage or injury arising as a result of any fault in the Products.
6. This warranty does not extend to damage to a Product which occurs during transit or transportation, or which is caused by any abuse, accident or improper installation, connection, use, adjustment or repair or use of goods otherwise than in accordance with instructions issued by K Care Healthcare Solutions.
7. The warranty on Products is waived if any addition or attachment to the Product does not have K Care Healthcare Solutions approval or are not sold as K Care Healthcare Solutions products. The Product is designed to perform specific tasks under established test loads and unauthorised attachments may produce stresses for which the design is not appropriate.
8. The following applies to consumers who purchased a relevant Product in Australia:

Our goods come with guarantees that cannot be excluded under the Australian Consumer Law. You are entitled to a replacement or refund for a major failure and compensation for any other reasonably foreseeable loss or damage. You are also entitled to have the goods repaired or replaced if the goods fail to be of acceptable quality and the failure does not amount to a major failure.

Contact information

K Care Healthcare Solutions	Telephone	1300 783 783
836A Fifteenth Street	Facsimile	1300 784 784
Mildura VIC 3500	Email	customerservice@kcare.com.au

CORD AND TRANSFORMER CONNECTIONS

Once the box has been removed from around the chair, you'll notice the back is resting on top of the seat. There are a couple of items to remove from the seat portion of the chair first.

Follow the steps below:

1. Remove the zip tie holding the plastic bag with the Power Transformer, hand wand and its cord on the left.
2. Remove the hand wand from the plastic bag and connect it to the female plug located in the left side pocket on the outside of the chair's arm.
3. Connect the Power Transformer to the plug coming from the chair.
4. Connect the Power Cord into the Power Transformer.
5. Connect the Power Cord into an electrical outlet, near where the chair will be positioned.

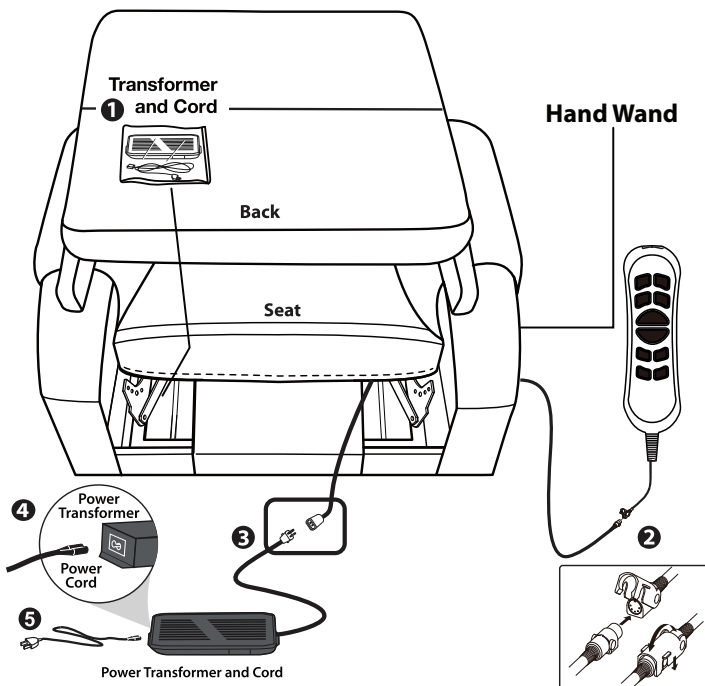

CHAIR ASSEMBLY:

ATTACHING THE CHAIR BACK TO THE CHAIR BASE

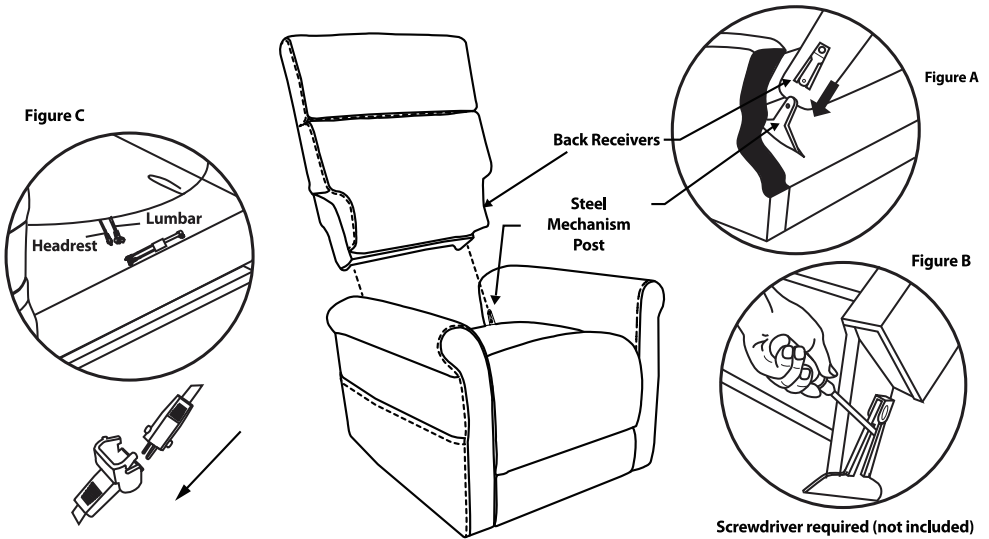

CAUTION: PLEASE READ ALL INSTRUCTIONS CAREFULLY BEFORE STARTING ASSEMBLY PROCESS. IT IS RECOMMENDED TO USE TWO PEOPLE WHEN ASSEMBLING AND REMOVING THE INSIDE BACKS TO AND FROM THE BASE OF THE FURNITURE.

1. Slide inside back receivers onto the steel mechanism posts in the base of the chair (Figure A).
2. Press both sides of the back firmly into place until the back automatically locks into place.
3. To remove the back from the base, use a screwdriver pressing outward on the black tab in the metal receivers on both sides of the chair back and lift the back from the base of the chair (Figure B).
4. Connect the Headrest and Lumbar cable plugs (Figure C). Headrest-only models feature one less set of cables.

CHAIR ASSEMBLY:

ATTACHING THE CHAIR WINGS TO THE CHAIR BACK

1. Slide the metal inserts on the chair's wings into the metal sleeves on the side of the chair back.
2. Slide the wings down until they are completely set on the back's metal sleeves.

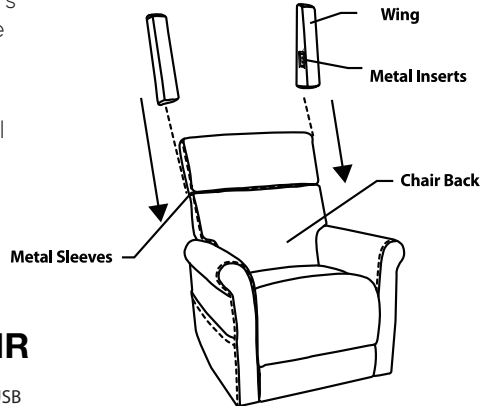

OPERATING YOUR LIFT CHAIR

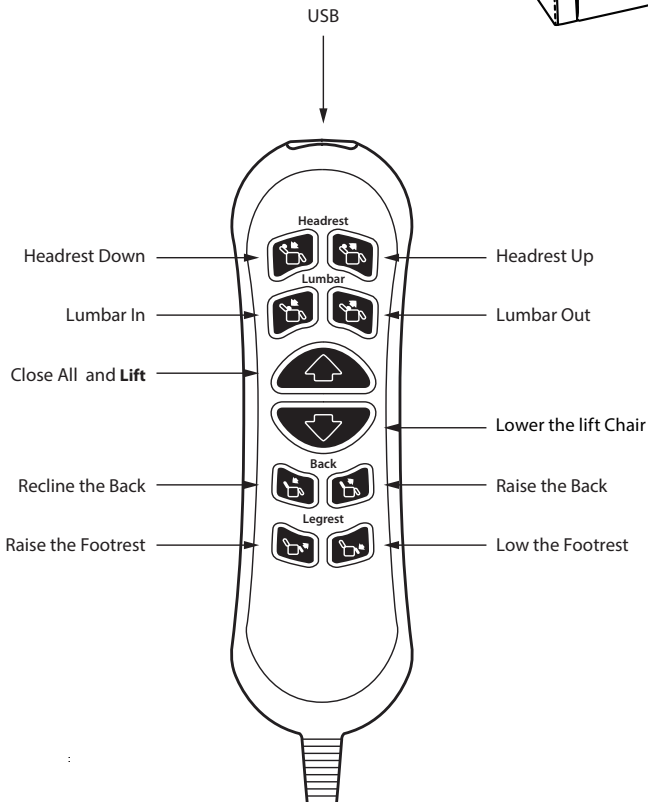

INSTALLATION OF BACK-UP BATTERIES

2 - 9 Volt back-up batteries will lift the chair from the reclined position to the seating position one cycle in case of a power failure. If a power failure occurs and the chair is cycled, the 2-9 Volt batteries will need to be replaced.

1. Remove the sliding door on the side of the transformer to locate the 2 - 9 Volt batteries.
2. Pull out the 2- 9 Volt batteries and replace with new batteries.
3. Replace door on the transformer.
4. Batteries not included.

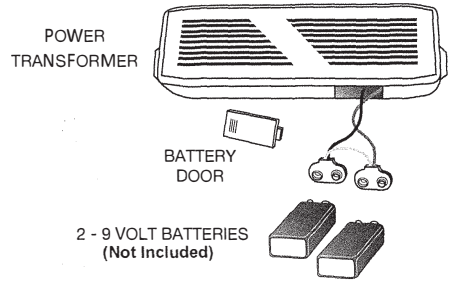

LITHIUM-ION BATTERY PACK BACK-UP SYSTEM

If your chair is equipped with an external transformer with a lithium-ion battery pack, your chair may be operated without being plugged into an electrical outlet for up to 48 hours.

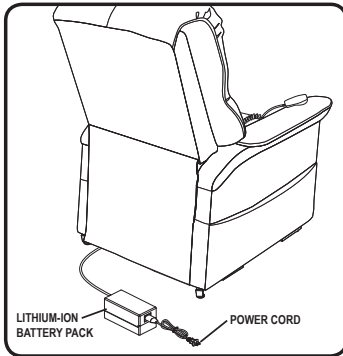

Figure A Chair Battery Back-up Location

Follow these steps to replace the lithium-ion battery pack batteries:

1. Unplug the external transformer power cord from the electrical outlet.
2. Position the external transformer so that the lithium-ion battery is facing upward (Figure A).
3. Gently bump with your hand the end of the lithium-ion battery pack to dislodge it from external transformer.
4. Slide the lithium-ion battery until it stops and then lift the lithium-ion battery off of the external transformer.
5. Place the new lithium-ion battery on top of the external transformer with the securement grooves toward the external transformer. (Figure B).
6. Slide the new lithium-ion battery onto the external transformer until it clicks into place.

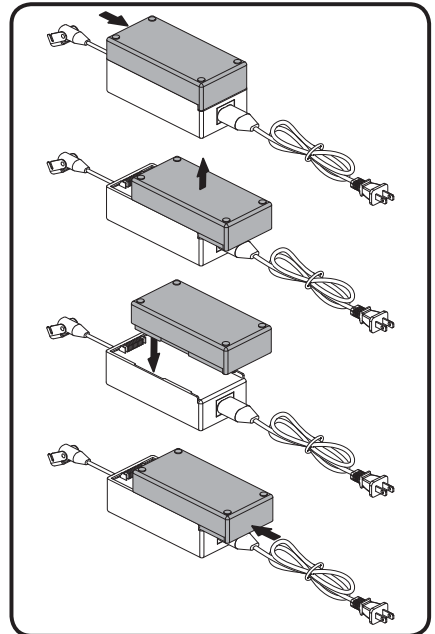

Figure B Lithium-Ion Battery Replacement

NOTE: Remove the lithium-ion battery from the battery pack when your chair isn't being used for an extended period of time. The chair will draw power from the battery even when it is not in use.

TROUBLESHOOTING

PROBLEM	POSSIBLE FACTORS	SOLUTIONS
The chair doesn't recline or lift	The transformer may not be connected well	Check the power supply has been correctly connected to the socket and confirm the wire from chair to transformer is firmly connected
The headrest or lumbar doesn't work	The headrest or lumbar motor may not be connected well	Check the headrest and lumbar motor has been correctly connected to the socket
The headrest and lumbar work oppositely	The headrest and lumbar motor plug	Check the headrest and lumbar motor has been correctly connected to the socket
The hand wand doesn't work	The hand wand may not be connected well	Check the hand wand cord has been correctly connected to the socket

All information is considered to be true and correct at the date of publication. Changes in circumstances after the time of publication may impact on the accuracy of the information.

202002_1.2

Improving your life everyday™

At Your Service

**Sales, administration
and general enquiries**

National 1300 783 783

Your Customer Service Team

customerservice@kcare.com.au

kcare.com.au