

4-BIT BINARY 7-SEGMENT DECODER DRIVER

- 4-BIT BINARY CODE INPUT GENERATES 1 TO 16 NUMBERS ON OUTPUT
- DIRECT DRIVING OF 1 AND 1/2 DIGIT 7-SEGMENT (COMMON CATHODE) LED DISPLAY
- WIDE SUPPLY VOLTAGE RANGE
- TTL COMPATIBLE INPUTS
- SMALL QUIESCENT SUPPLY CURRENT
- SPECIFICALLY DESIGNED FOR TV OR RADIO APPLICATIONS

The M 192 is a monolithic integrated circuit which direct drives a 1 and 1/2 digit 7-segment LED (common cathode) display to present the numbers 1 to 16. The inputs accept a 4-bit binary code having TTL levels. This device is especially designed to show the program number in TV or radio sets in conjunction with M 190 keyboard encoder, M 1130 ultrasonic remote control receiver, M 193 electronic program memory or H 770/1/2/3 analog switches. All outputs are designed to supply and sink current, except the additional "r" output (pin 1) which is designed for a brightness control in a current generator configurations. The circuit is produced in COS/MOS technology and is supplied in a 16-pin dual in-line plastic package.

ABSOLUTE MAXIMUM RATINGS*

V_{DD}^{**}	Supply voltage	-0.5 to 16.5	V
V_I	Input voltage	-0.5 to $V_{DD} + 0.5$	V
V_O	Output voltage (pin 1)	$V_{DD} + 0.5$	V
I_{OH}	Output source current	-25	mA
I_{OL}	Output sink current (except pin 1)	10	mA
P_{tot}	Total package power dissipation	400	mW
T_{stg}	Storage temperature	-65 to 150	°C
T_{op}	Operating temperature	0 to 70	°C

* Stresses above those listed under "Absolute Maximum Ratings" may cause permanent damage to the device. This is a stress rating only and functional operation of the device at these or any other condition above those indicated in the operational sections of this specification is not implied. Exposure to absolute maximum rating conditions for extended periods may affect device reliability.

** All voltages are with respect to V_{SS} (GND).

ORDERING NUMBER: M 192 B1

MECHANICAL DATA

Dimensions in mm

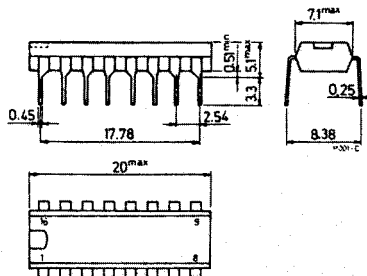

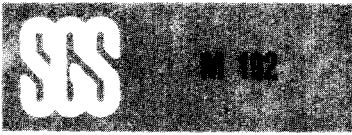

PIN CONNECTIONS

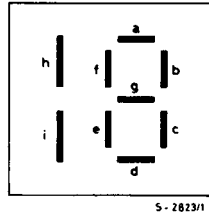
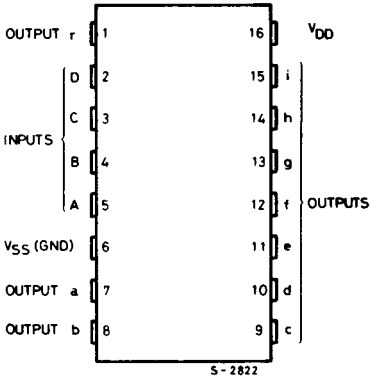

TRUTH TABLE

INPUTS				Number displayed	OUTPUTS									
A	B	C	D		a	b	c	d	e	f	g	h	i	r
L	L	L	L	1	L	H	H	L	L	L	L	L	L	H
H	L	L	L	2	H	H	L	H	H	L	H	L	L	H
L	H	L	L	3	H	H	H	H	L	L	H	L	L	H
H	H	L	L	4	L	H	H	L	L	H	H	L	L	H
L	L	H	L	5	H	L	H	H	L	H	H	L	L	H
H	L	H	L	6	H	L	H	H	H	H	H	L	L	H
L	H	H	L	7	H	H	H	L	L	L	L	L	L	H
H	H	H	L	8	H	H	H	H	H	H	H	L	L	H
L	L	L	H	9	H	H	H	H	L	H	H	L	L	H
H	L	L	H	10	H	H	H	H	H	H	L	H	H	H
L	H	L	H	11	L	H	H	L	L	L	L	H	H	H
H	H	L	H	12	H	H	L	H	H	L	H	H	H	H
L	L	H	H	13	H	H	H	H	L	L	H	H	H	H
H	L	H	H	14	L	H	H	L	L	H	H	H	H	H
L	H	H	H	15	H	L	H	H	L	H	H	H	H	H
H	H	H	H	16	H	L	H	H	H	H	H	H	H	H



INPUT CONFIGURATION

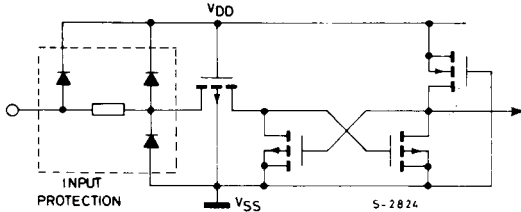

OUTPUT CONFIGURATION

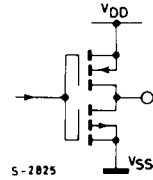

Note: pin 1 has not the pull down N-channel transistor.

RECOMMENDED OPERATING CONDITIONS

V_{DD}	Supply voltage	10.8 to 15	V
V_I	Input voltage	0 to V_{DD}	V
V_O	Output voltage (pin 1)	V_{DD}	V
I_{OH}	Output source current	max -10	mA
I_{OL}	Output sink current	max 0.5	mA
T_{op}	Operating temperature	0 to 70	°C

ELECTRICAL CHARACTERISTICS (over recommended operating conditions)

typical values are at $T_{amb} = 25^\circ\text{C}$ unless otherwise specified

Parameter	Test conditions	Values			Unit	
		Min.	Typ.	Max.		
V_{IH}	High level input voltage	3.5		V_{DD}	V	
V_{IL}	Low level input voltage	0		0.8	V	
I_{IH}	High level input current	$V_{DD} = 15\text{V}$	$V_{IH} = 15\text{V}$	10	μA	
I_{T+}	Input current at positive threshold	$V_{DD} = 15\text{V}$		200	μA	
V_{OH}	High level output voltage	$I_{OH} = -10\text{mA}$	$V_{DD} = 10.8\text{V}$ $V_{DD} = 13\text{V}$ $V_{DD} = 13\text{V}, T_{amb} = 70^\circ\text{C}$ $V_{DD} = 15\text{V}$	$V_{DD} - 3$	V V V V	
V_{OL}	Low level output voltage (except pin 1)	$V_{DD} = 13\text{V}$	$I_{OL} = 0.5\text{mA}$	1	1.5	V
I_{DD}	Supply current Input to V_{DD} Outputs open	$V_{DD} = 15\text{V}$		2	2.4	mA



APPLICATION INFORMATION

Fig. 1 - Light emitting diode readout

a - Current generator configuration

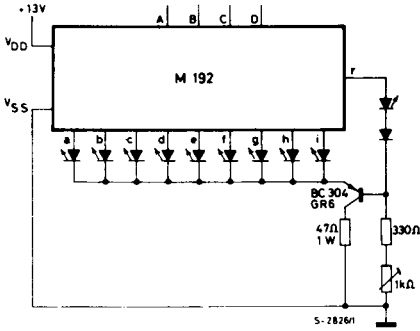

b - Standard configuration

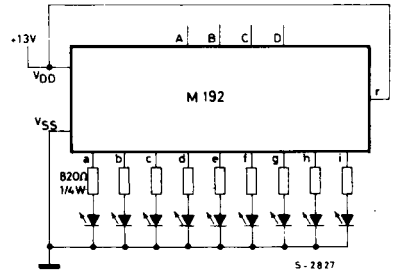

Fig. 2 - Liquid crystal readout

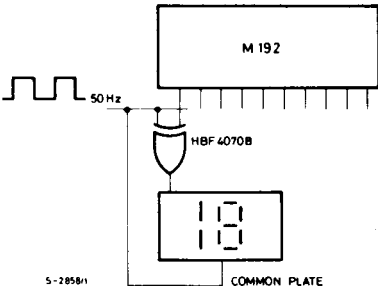

Fig. 3 - Fluorescent readout

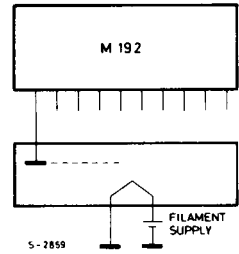

Fig. 4 - Incandescent readout

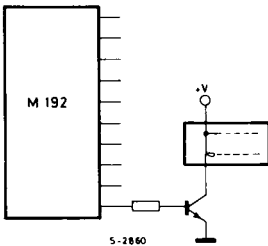
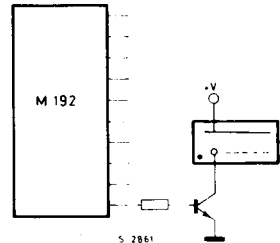

Fig. 5 - Gas discharge readout



TYPICAL APPLICATIONS (continued)

Program display with stand-by indication

This application is useful in a remote controlled set. The stand-by condition of the set, i.e. when only the remote control is supplied, is shown by two dots. The program display number is controlled by the same output of the remote control receiver as that which drives the mains relay.

Fig. 6

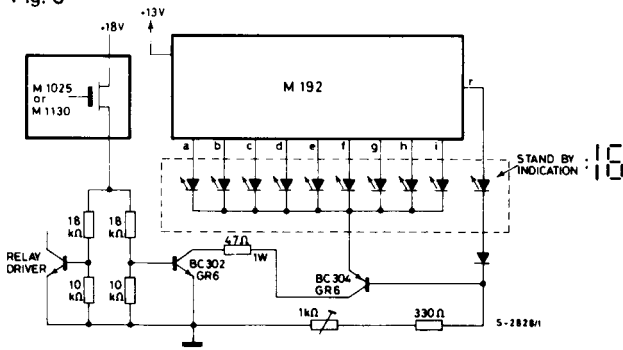
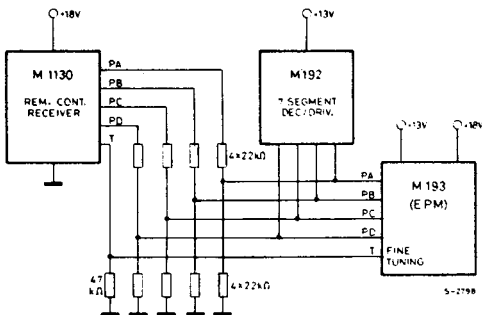

Fig. 7 - M 192 interfacing

a



b

