

PATIO L-PLUS THERMO SAUNA























INSTALLATION MANUAL

Instructions

1. It is recommended to install the sauna above ground level to prevent the base frame of the sauna from coming into direct contact with the ground. Install a water-resistant material, such as bitumen strips, between the base frame and the base surface.
2. Make sure that the surface on which you install the sauna is level and stable before and after installing the sauna. Otherwise, the doors of the sauna may not open and close properly later on.
3. During the first heating of the sauna, it must be constantly supervised, and the doors should be kept open, as the stove emits a specific odor when first heated. Read more from the user manual for the sauna stove.
4. The maximum permitted temperature in the steam room is +90 °C. If heated to a higher temperature, the sauna may become overheated.
5. In order to avoid damage caused by the weight of snow in winter, any snow should be removed from the roof of the sauna. Keep in mind that the roof covering should not be damaged during snow removal.
6. If your sauna has lighting, install a 3G 2,5 mm outdoor power cable and connect it in accordance with the schematics on the plug socket coupler provided with the sauna. The power cable of the sauna must be connected to a residual-current circuit breaker! Consult an electrician if necessary.

Required tools

| | | | | | |
|---|---------------|---|--------------------|---|-------------------|
|  | Tape measure |  | Cutting knife |  | Respirator |
|  | Pencil |  | Battery drill |  | Scissors |
|  | Level |  | Nail gun |  | Tin shears |
|  | Rubber mallet |  | Circular saw |  | Pliers |
|  | Hammer |  | Gloves |  | Hole saw Ø 100 mm |
|  | Hand saw |  | Safety goggles |  | Jigsaw |
|  | Silicone gun |  | Wood drill Ø 14 mm | | |

Floor plan

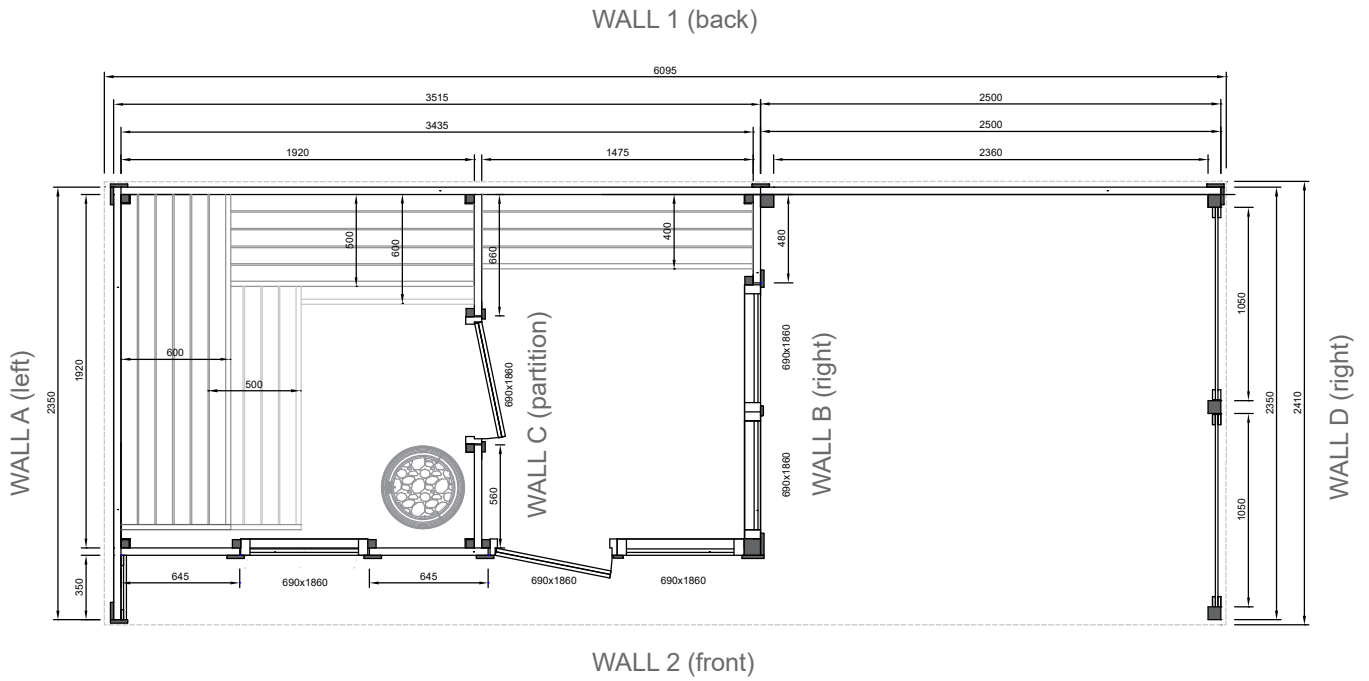

Cross section

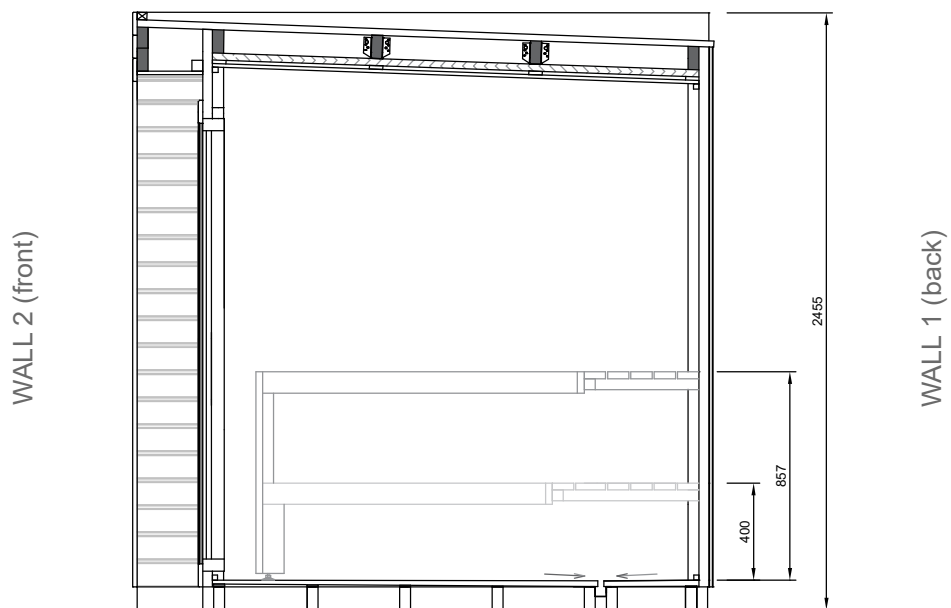

STEP 1 - Base frame

| Marking | Detail | Image | Note | Length | Pcs. |
|---------|------------------|-------|----------------|--------|------|
| AR-1 | 45x95 Base Frame | | | 3460 | 2 |
| AR-2 | 45x95 Base Frame | | | 3415 | 2 |
| AR-3 | 45x95 Base Frame | | | 2505 | 1 |
| AR-4A | 45x95 Base Frame | | <i>Cutout!</i> | 2345 | 1 |

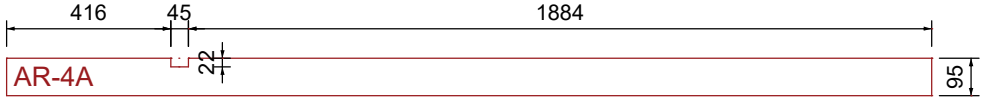

| | | | | | |
|------|------------------|--|--|------|---|
| AR-5 | 45x95 Base Frame | | | 1900 | 6 |
| AR-6 | 45x95 Base Frame | | | 1810 | 1 |
| AR-7 | 45x95 Base Frame | | | 1470 | 4 |
| VR-1 | Drainage detail | | | 1980 | 1 |

| Marking | Detail | Image | Note | Length | Pcs. |
|---------|------------|-------|----------------|--------|------|
| | Screw 5x90 | | for base frame | | 65 |

1.1 Connect the base frame details according to Scheme 1.1.

Make sure that the frame is level and that the diagonals are equal ($X = Y$). Leave a 45 mm gap between two AR-1 base frame details so that the water drainage detail VR-1 can be fitted between them.

Use a level, a battery drill, and 5x90 screws to join the base frame together.



1.2 Place the VR-1 drainage detail on top of the base frame.

No fixings are needed.

Caution! The detail has sharp edges; use gloves.



Check diagonals: $X=Y$

$X = 4031$ mm



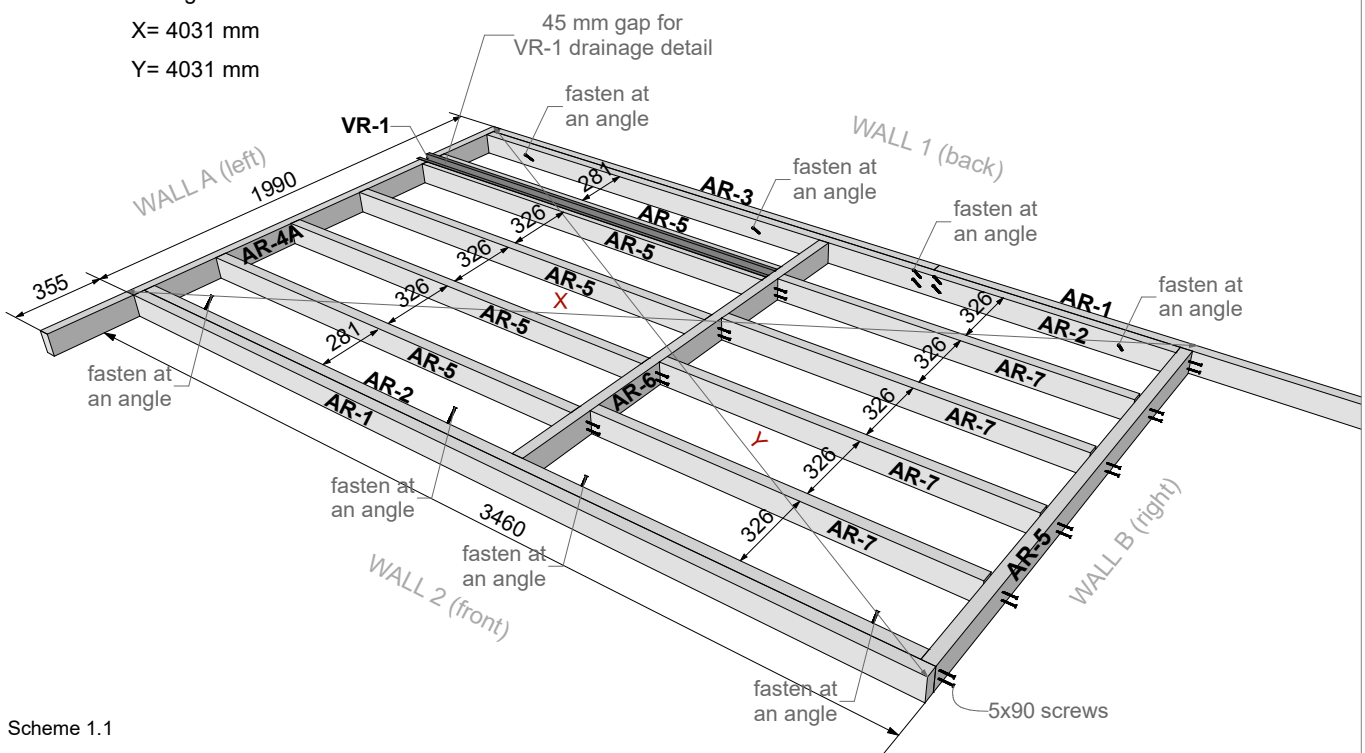



$Y = 4031$ mm

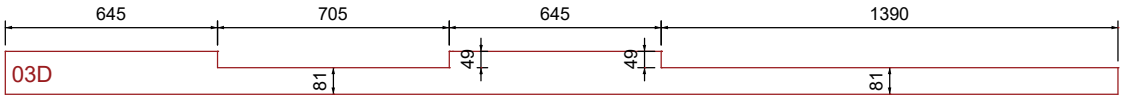

Scheme 1.1

Attention! If a terrace has also been ordered, please see the additional page of installation instructions for the sauna with a terrace.

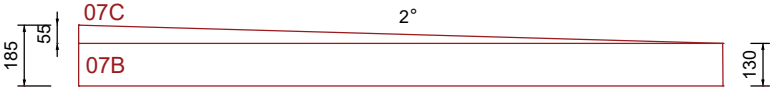
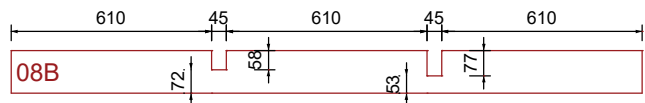
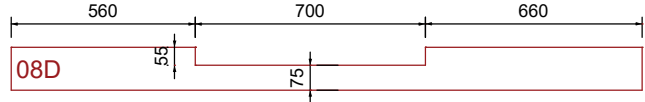
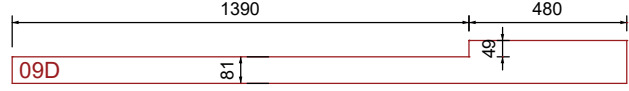
STEP 2 - Walls

| Marking | Detail | Image | Note | Length | Pcs. |
|--|------------------------|---|-----------------------|--------|------|
| 01 | 40x138 Wall Log Thermo | | | 3475 | 17 |
| EXTRA | 40x138 Wall Log Thermo | | | 3475 | 2 |
| 01B | 40x130 Wall Log Thermo |  | <i>Height: 130 mm</i> | 3475 | 1 |
| 02 | 40x138 Wall Log Thermo | | | 3435 | 3 |
| 02C | 40x55 Wall Log Thermo |  | <i>Height: 55 mm</i> | 3435 | 1 |
| 03D | 40x138 Wall Log Thermo | | <i>Cutout!</i> | 3385 | 1 |
|  | | | | | |
| 04 | 40x138 Wall Log Thermo | | | 2500 | 17 |
| 04B | 40x130 Wall Log Thermo |  | <i>Height: 130 mm</i> | 2500 | 1 |
| 05 | 40x138 Wall Log Thermo | | | 2350 | 18 |
| 05B | 40x115 Wall Log Thermo |  | <i>Height: 115 mm</i> | 2350 | 2 |
| 06 | 40x138 Wall Log Thermo | | | 2310 | 1 |
| 07 | 40x138 Wall Log Thermo | | | 1960 | 2 |
| 07B + 07C | 40x185 Wall Log Thermo | | <i>Wedge shaped</i> | 1960 | 1 |
|  | | | | | |
| 08 | 40x138 Wall Log Thermo | | | 1920 | 2 |
| 08B | 40x130 Wall Log Thermo | | <i>Cutout!</i> | 1920 | 1 |
|  | | | | | |
| 08D | 40x138 Wall Log Thermo | | <i>Cutout!</i> | 1920 | 1 |
|  | | | | | |
| 09D | 40x138 Wall Log Thermo | | <i>Cutout!</i> | 1920 | 1 |
|  | | | | | |
| 10 | 40x138 Wall Log Thermo | | | 660 | 14 |
| 11 | 40x138 Wall Log Thermo | | | 645 | 28 |
| 12 | 40x138 Wall Log Thermo | | | 560 | 14 |
| 13 | 40x138 Wall Log Thermo | | | 480 | 14 |
| EXTRA | 40x138 Wall Log Thermo | | | 660 | 4 |
| | Hitting Block |  | | | 2 |

STEP 2 - Walls

| Marking | Detail | Image | Note | Length | Pcs. |
|---------|-------------------------|-------|------------------------------|--------|------|
| P-0 | 90x90 Corner Post | | <i>Cut to length</i> | 2430 | 1 |
| P-1 | 45x45 Corner Post | | | 2340 | 2 |
| P-2 | 45x45 Corner Post | | | 2285 | 3 |
| P-3 | 70x70 Support Post | | <i>Cutout!</i> | 2340 | 2 |
| P-4 | 70x70 Support Post | | <i>Cutout!</i> | 2305 | 1 |
| P-5 | 70x70 Corner post | | | 2340 | 1 |
| AT-1 | 45x45 Temporary Support | | for corner post installation | ~1800 | 10 |

| Marking | Detail | Image | Note | Length | Pcs. |
|---------|-------------------------|-------|-------------------------------|---|------|
| | Adjustable post support | | for P-3 & P-4 support posts |  | 3 |
| | Screw 6x180 | | for P-0 post & every wall log | | 300 |
| | Screw 4.5x70 | | | | 400 |
| | Screw 3.5x50 | | for P-3 support posts | | 30 |
| | Screw 5x90 | | for P-5 corner post | | 5 |
| | Wooden cover cap | | for P-5 corner post | | 5 |

2.1 Place the first row of wall logs on the base frame according to Scheme 2.1. Make sure that the wall logs protrude 5 mm outward from the base frame on all sides. Use 6x180 screws to fix the wall logs to the base frame.
Suggestion: Pre-drill the holes for the screws to prevent wall logs from splitting.

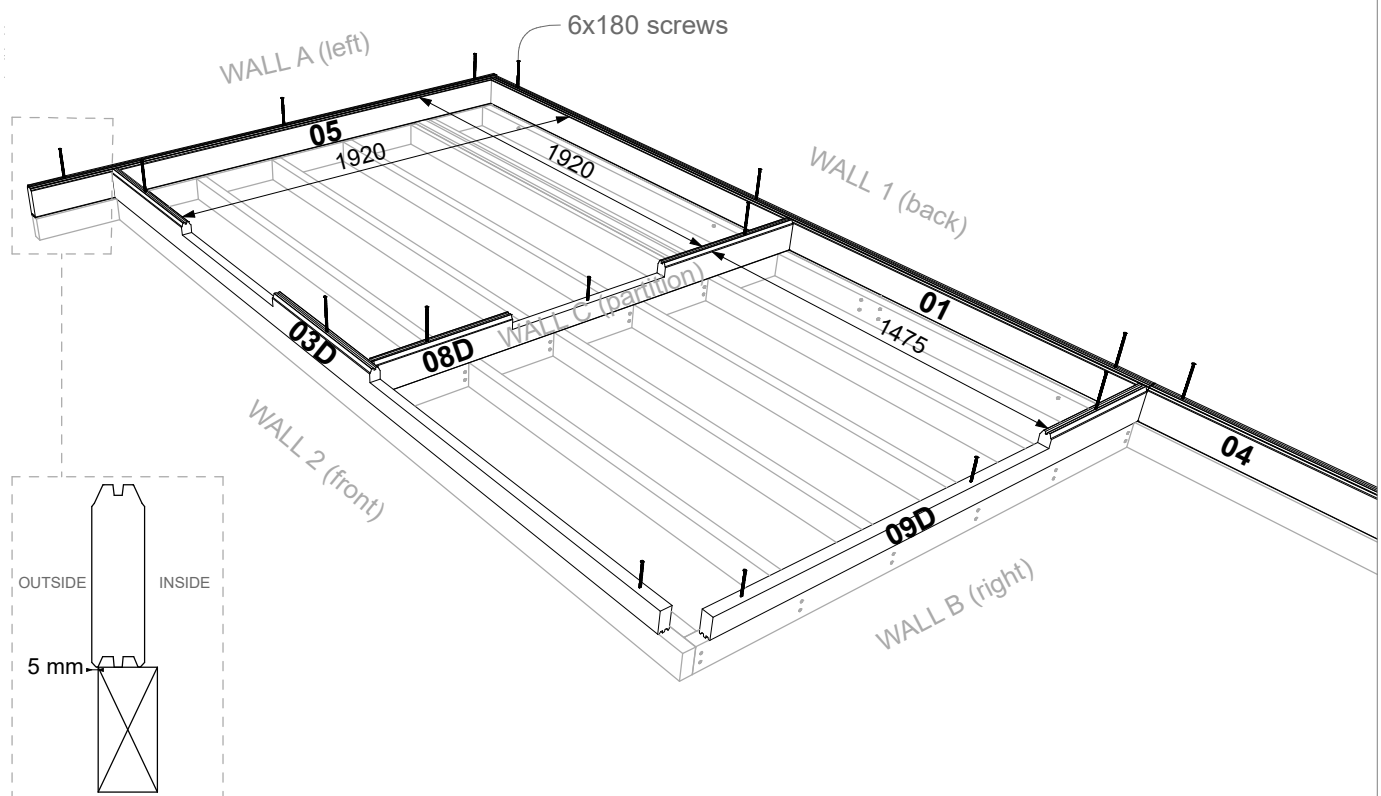
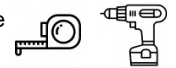

Scheme 2.1

2.2 Place the second row of wall logs on top of the first row. Use a hitting block and a rubber mallet to set the logs in place. Attach the second row to the first using 6x180 screws and a battery drill.

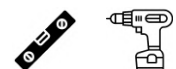

Suggestion: Pre-drill the holes for the screws to prevent wall logs from splitting.

2.3 Install corner posts in the inner corners. Leave a 45 mm gap at the bottom, between the corner posts and the base frame. Use 4.5x70 screws and a drill to fix the corner posts to every wall log (Scheme 2.2).

Suggestion: Pre-drill holes for the screws to prevent the posts from splitting.

STEP 2 - Walls

2.4 Vertically level the corner posts and temporarily attach AT-1 details to them for support and to keep the posts in a level position. Use a level, 4.5x70 screws, and a battery drill.

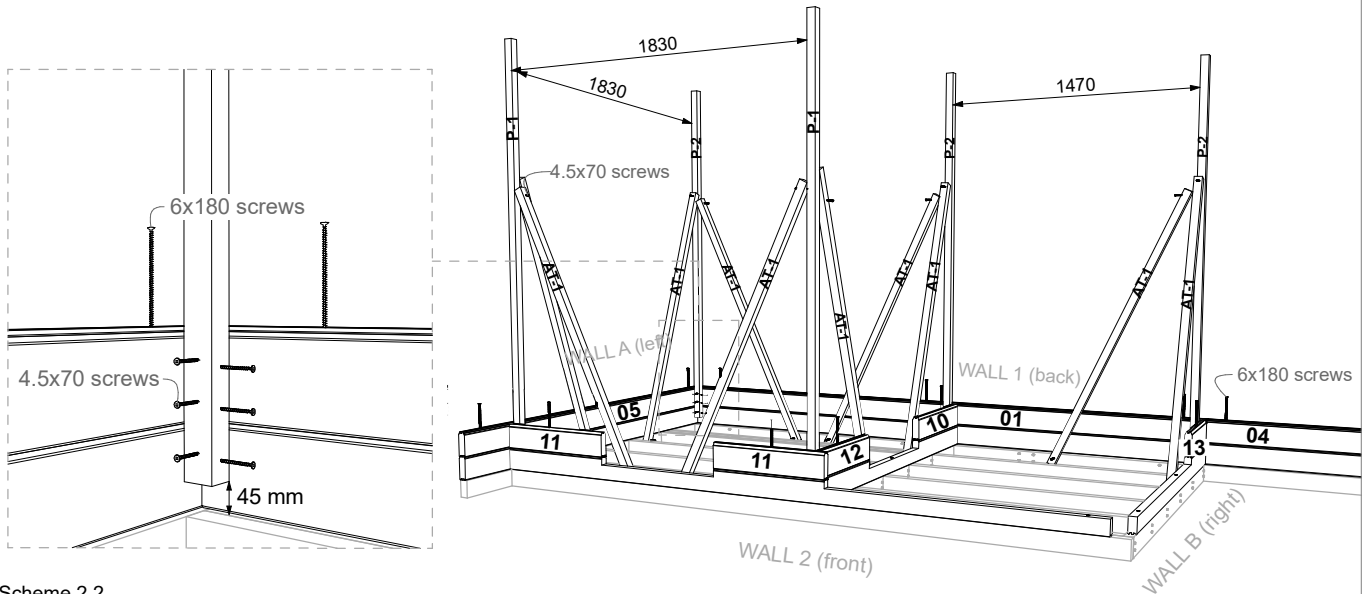
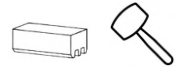

Scheme 2.2

2.5 Continue to install the wall logs on top of each other according to the "Wall Layout" scheme on page 7. Use 6x180 screws to connect all wall logs to each other and 4.5x70 screws to fix all logs to corner posts, like shown in Scheme 2.3.



2.6 Connect the back walls with the P-5 corner post. Drill five 15 mm deep hole into the P-5 post with a Ø14 mm wood drill and fasten the P-5 post to Wall B (right) with 3x90 screws through the pre-made holes. Cover the holes with wooden cover caps. Fix the 04 back wall logs to the P-5 corner post using 4.5x70 screws (2 per every wall log) from the outside.



2.7 Remove the AT-1 temporary support details after all wall logs have been installed.

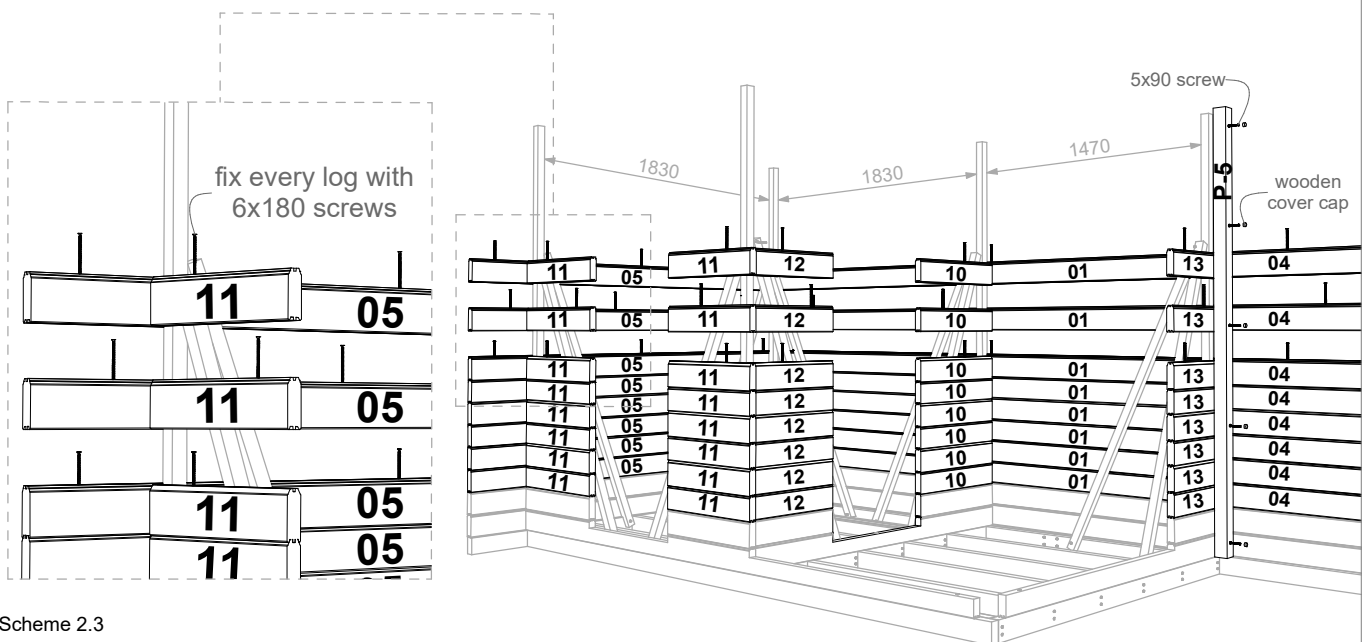

Scheme 2.3

For installation of walls, please see the placement of the wall logs on the "Wall Layout" scheme on page 7.

WALL LAYOUT

- * Connect all wall logs together using 6x180 screws.
- * Connect all wall logs to corner posts using 4.5x70 screws

Wall 2 (front)

View from the outside

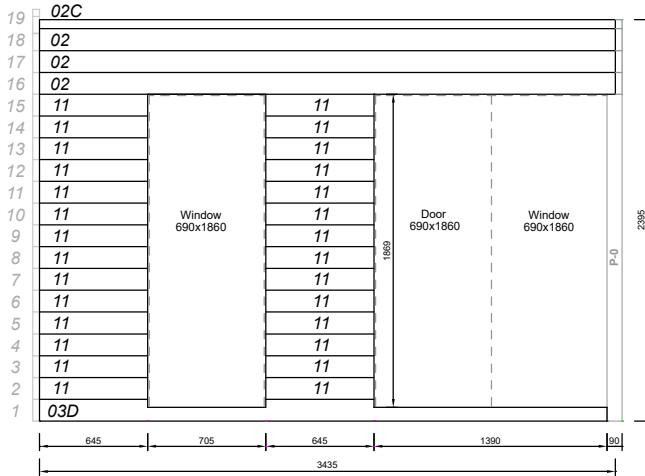

Wall A (left)

View from the outside

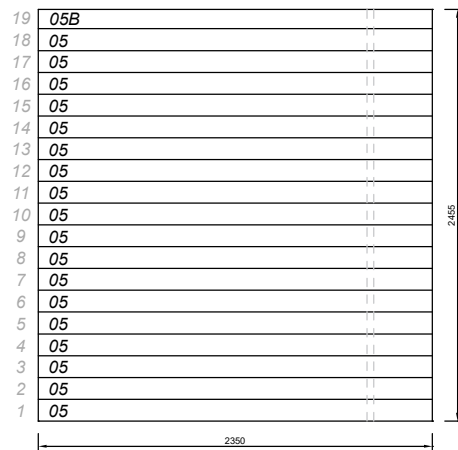

Wall 1 (back)

View from the outside

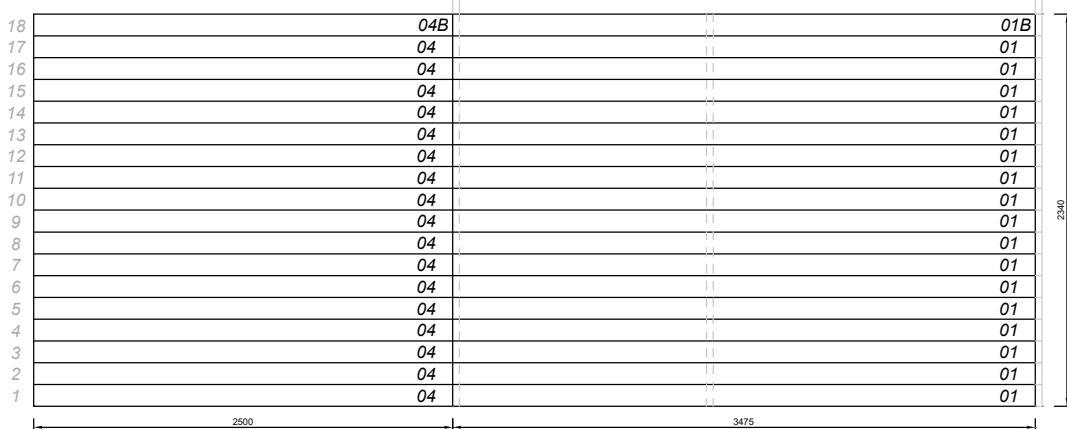

Wall B (right)

View from the outside

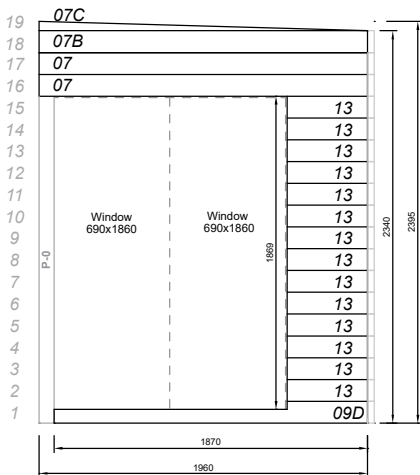

Wall C (partition)

View from the anteroom

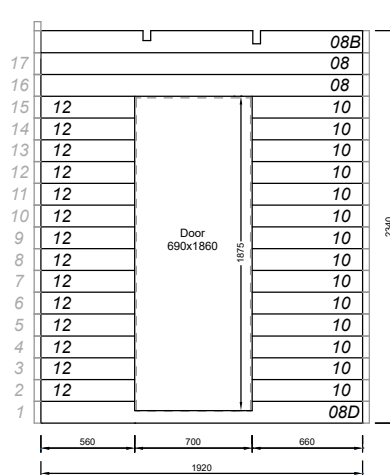

Wall D (right)

View from the outside

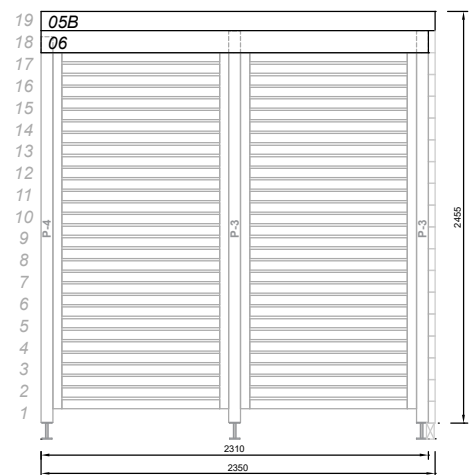

STEP 2 - Walls

- 2.8 Install the P-0 corner post. The length of the post is delivered with an oversize of ~50 mm. Measure the height of the window opening and cut the post to the right length at the bottom (see Scheme 2.4).

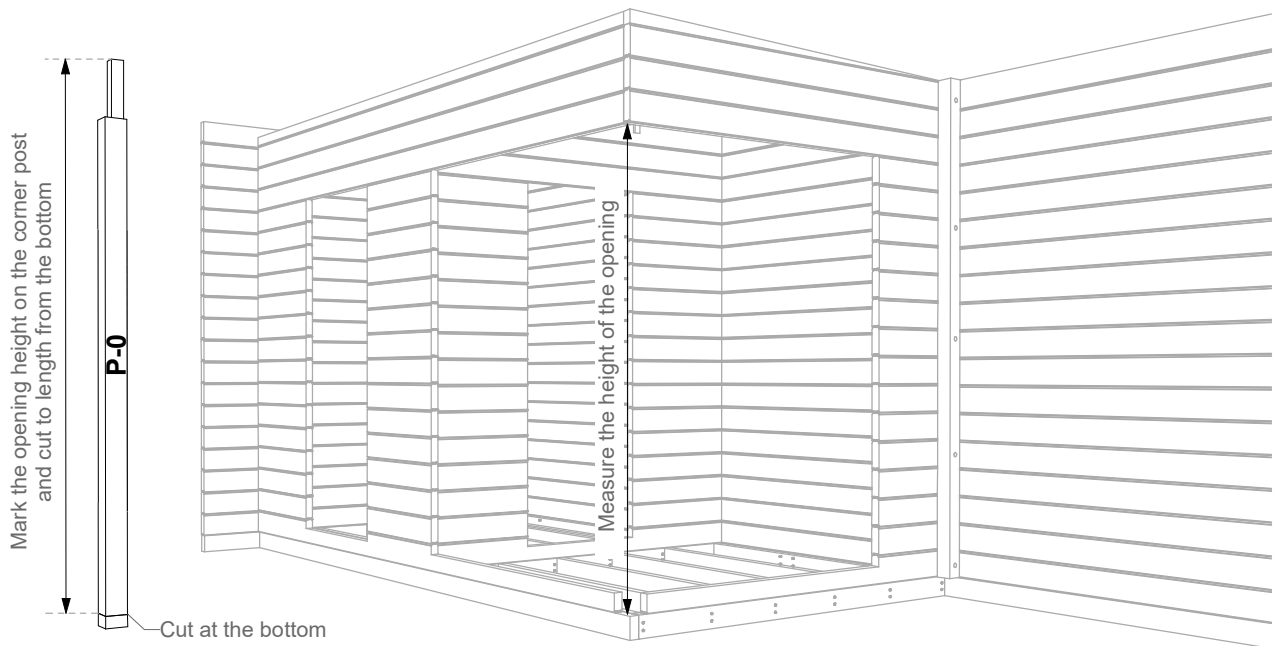

Scheme 2.4

- 2.9 Place the P-0 corner post in position and make sure it is level. Attach the corner post to the bottom row of wall logs with 6x180 screws (Scheme 2.5).



- 2.10 Fix the top four rows of logs to the corner post using 4.5x70 screws. The screws will later be covered with corner post moldings and will not remain visible.

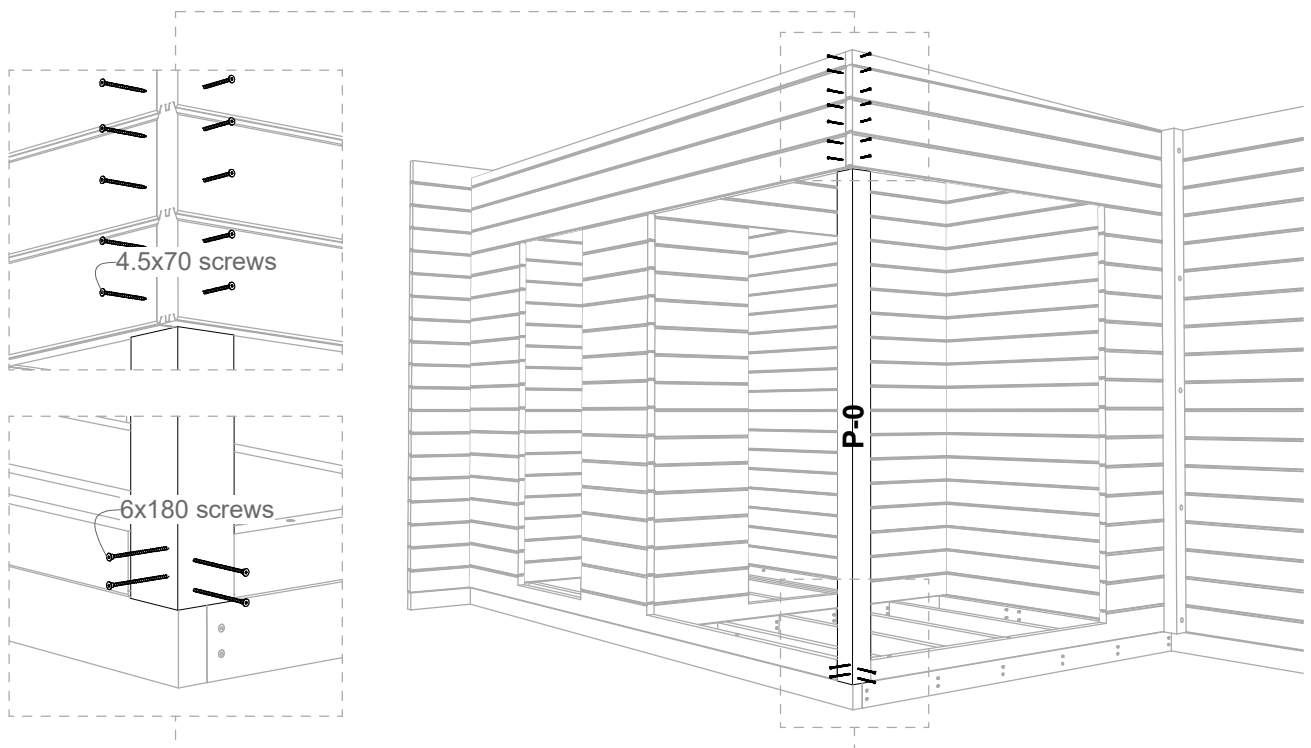

Scheme 2.5

STEP 2 - Walls

2.11 Attach the adjustable post supports to the bottom of the P-3 and P-4 posts with 3.5x50 screws. Install the posts and fasten them to the 03 wall log with 3.5x50 screws, like shown in Scheme 2.6.

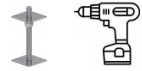

2.12 Adjust the post supports to the correct height and fix them to the base with suitable screws depending on the material.

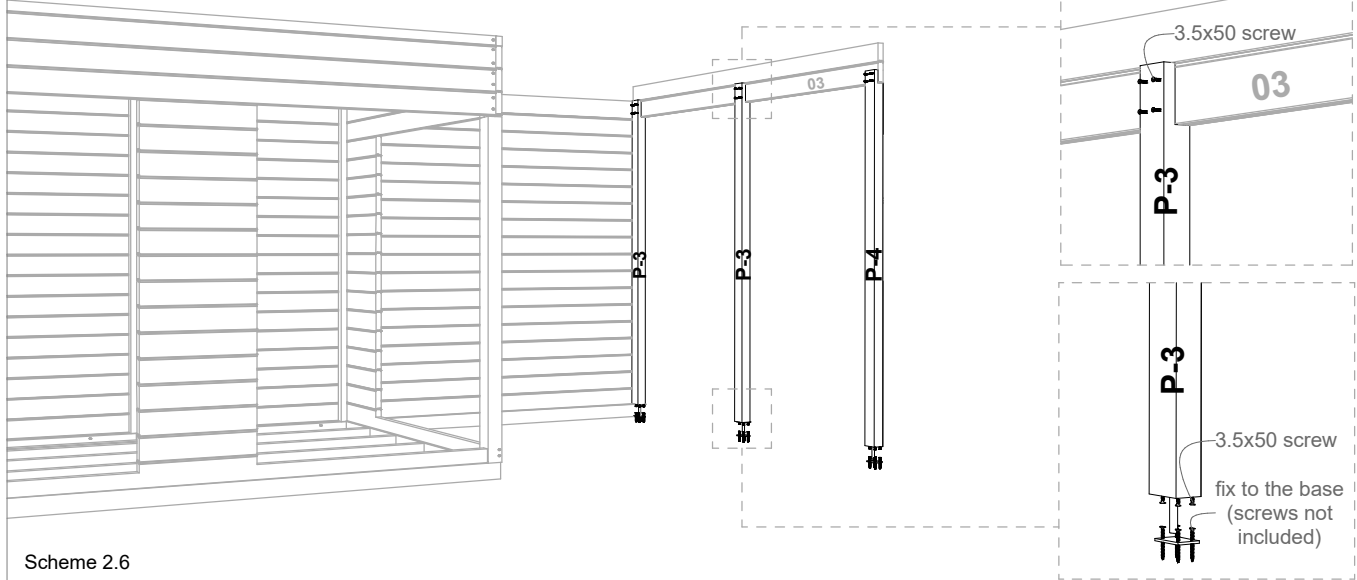

Scheme 2.6

STEP 3 - Roof boards and ceiling

| Marking | Detail | Image | Note | Length | Pcs. |
|---------|-------------------------------------|-------|-------------------------------|--------|------|
| KL-1 | 24x120 Roof Board | | | 2370 | 54+2 |
| 01F | 40x30 Roof Block | | | 2967 | 2 |
| T-1 | 45x145 Ceiling Beam | | | 2415 | 3 |
| T-2 | 45x145 Ceiling Beam Support | | | 305 | 1 |
| T-3 | 45x95 Ceiling Beam | | | 3500 | 2 |
| T-4 | 45x95 Ceiling Beam | | | 3433 | 2 |
| T-5 | 45x95 Ceiling Beam | | | 2435 | 1 |
| T-6 | 45x95 Ceiling Beam | | | 2405 | 1 |
| T-7 | 45x95 Ceiling Beam | | | 2355 | 1 |
| T-8 | 45x95 Ceiling Beam | | | 2195 | 1 |
| T-8A | 45x95 Ceiling Beam | | <i>Wedge shaped</i> | 2195 | 1 |
| T-9 | 45x95 Ceiling Beam | | | 1825 | 2 |
| T-10 | 45x95 Ceiling Beam | | | 1420 | 2 |
| DI-3 | 15x55 Sauna Ceiling Distance Board | | | 1915 | 2 |
| DI-4 | 15x55 Sauna Ceiling Distance Board | | | 1825 | 2 |
| DI-6 | 15x55 Anteroom Ceiling Dist. Board | | | 1470 | 2 |
| DI-7 | 15x55 Anteroom Ceiling Dist. Board | | | 1420 | 2 |
| | SPU Insulation Panel 30x600x1200 | | | | 10 |
| STP-1 | 15x90 Sauna Ceiling Board | | <i>Thermo spruce</i> | 1915 | 43+2 |
| Marking | Detail | Image | Note | Length | Pcs. |
| | Joist Hanger 45x137 | | for fixing 45x145 beams | | 6 |
| | Joist Hanger 45x97 | | for fixing 45x95 beams | | 4 |
| | Metal Angle Bracket 90x90x90 | | for T-2 and T-3 beam | | 4 |
| | Screw 6x180 | | for T-2 and T-3 beam | | 10 |
| | Screw 5x90 | | for T-2 and T-3 beam | | 10 |
| | Screw 5x40 | | for joist hangers | | 80 |
| | Screw 4.5x70 | | for beams and distance boards | | 100 |
| | Nail 70 mm | | for KL-1 roof boards | | 500 |
| | Lost-head nail 40 mm | | for STP-1 ceiling boards | | 200 |
| | Foil Tape | | for SPU insulation panels | 10 m | 3 |

STEP 3 - Roof boards and ceiling

- 3.1 Attach the T-8 and T-9 beams to the front and back walls. Leave ~2 mm gap at both ends. Make sure that the top side of the beam is flush with the upper edge of the front and back walls. Use 4.5x70 screws and a drill to fix the beams to the walls (Scheme 3.1).
- 3.2 Place the T-7A wedge shaped beam on top of the T-7 beam and fix them both to Wall B (right), flush with the upper edge of the wall. Use 4.5x70 screws for fixing.

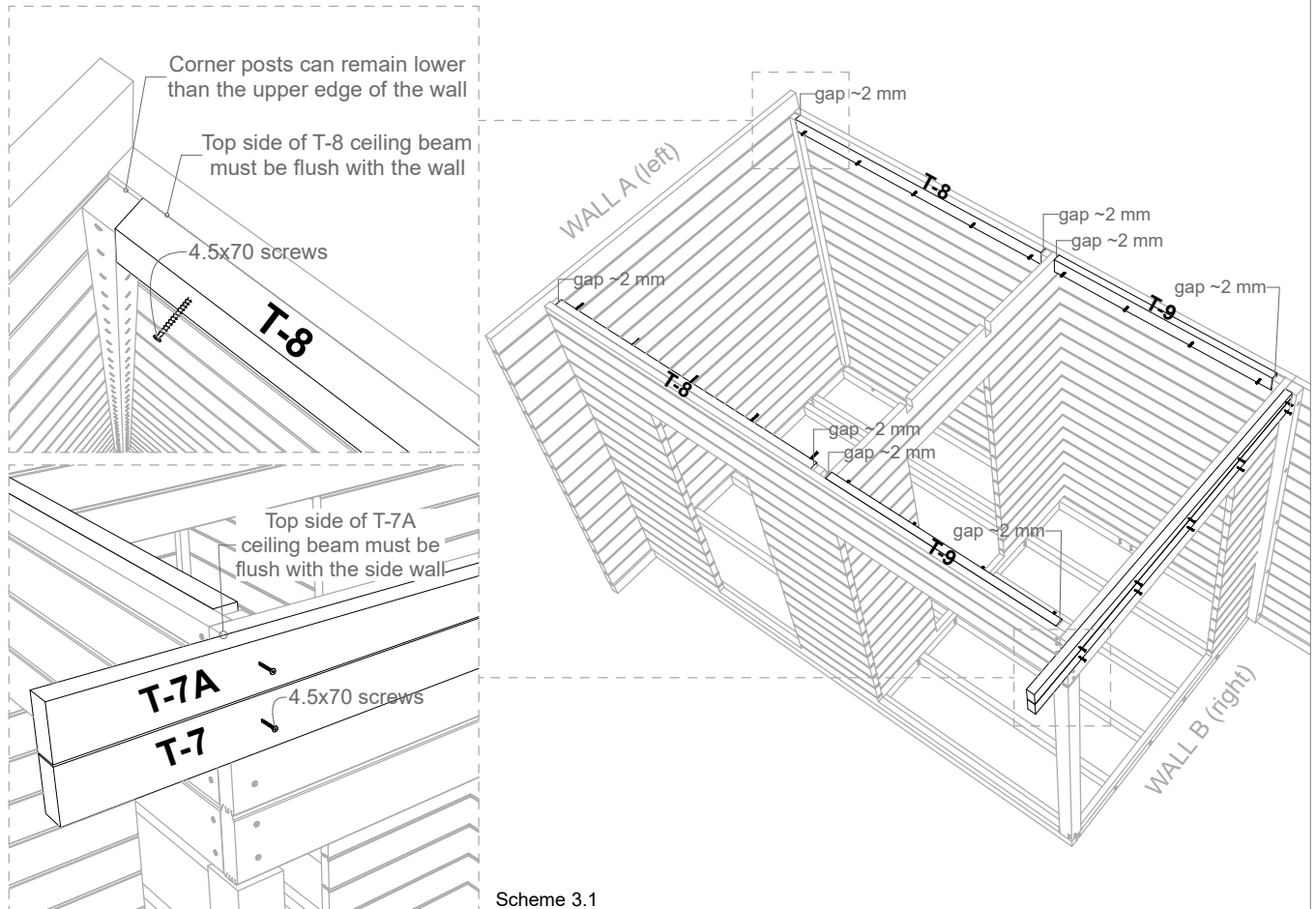

Scheme 3.1

- 3.3 Temporarily lay one KL-1 roof board or some other straight detail on top of the front and back walls of the sauna. Mark the diagonal that forms under the detail on the side walls with a pencil. These markings will determine the installation height of the T-3 ceiling beams. Measure out the distance from T-8 and T-9 beams and mark the locations on both side walls of the sauna, like shown in Scheme 3.2. These markings will indicate the spacing between the T-3 ceiling beams.

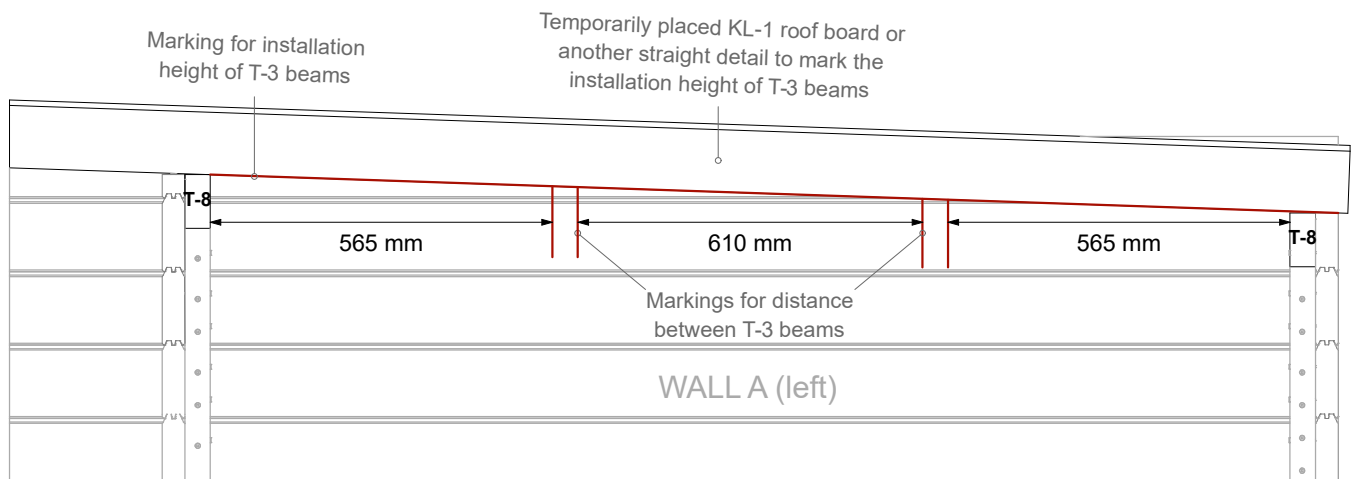

Scheme 3.2

STEP 3 - Roof boards and ceiling

3.4 Attach the joist hangers to the T-3 ceiling beams, flush with the beams ends (Scheme 3.3). Use 5x40 screws.

3.5 Install the T-3 ceiling beams through the cutouts in Wall C (partition). Fasten them to the side walls in the previously marked location through the joist hangers, like shown in Scheme 3.3. Use 5x40 screws to fix the joist hangers to the beams and the walls.



The T-3 beams should support the roof boards in the middle of the sauna. If necessary, raise the beams higher from the cutouts in Wall C (partition) and position them to the correct height using plastic wedges.

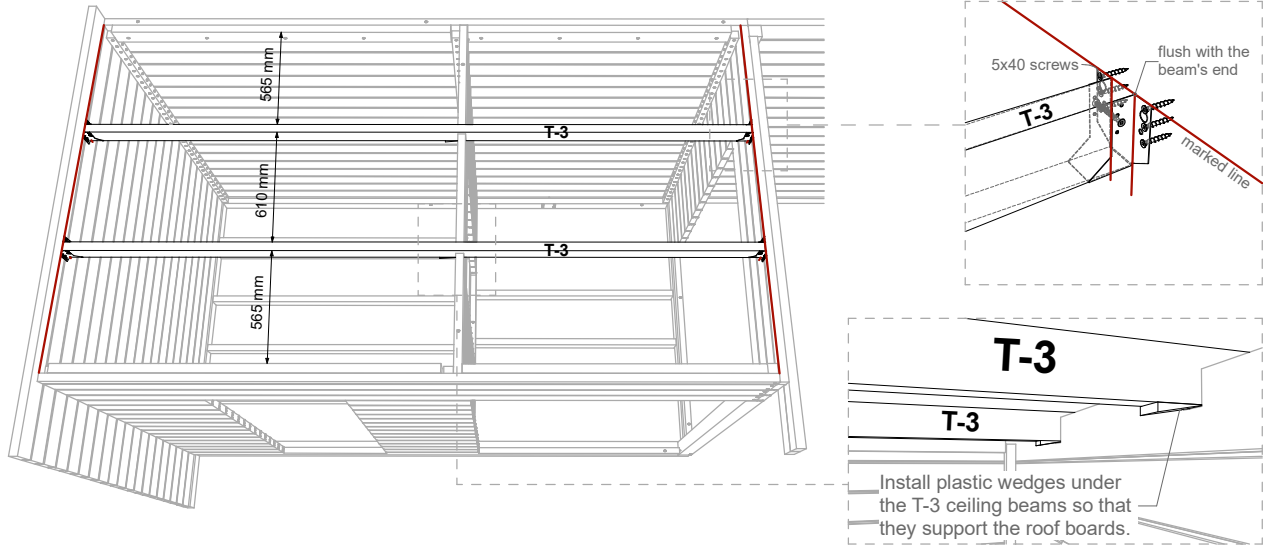

Scheme 3.3

3.6 Place two T-2 beams on top of each other and connect them with 6x180 screws. Then place T-4 and T-5 beams on top of each other, with ends even at the left side, leaving an offset at the right. Join the beams together with 6x180 screws.



3.7 Place the joined T-4 and T-5 beams on top of the P-4 post, so that it supports the T-5 beam on the right end. Fasten the joined beams to Wall A (left) and to Wall D (right) from the outside with 5X90 screws. At the center, fasten them to T7 and T-7A beams through 90x90x90 metal andngle bracket with 5x40 screws (Scheme 3.4).

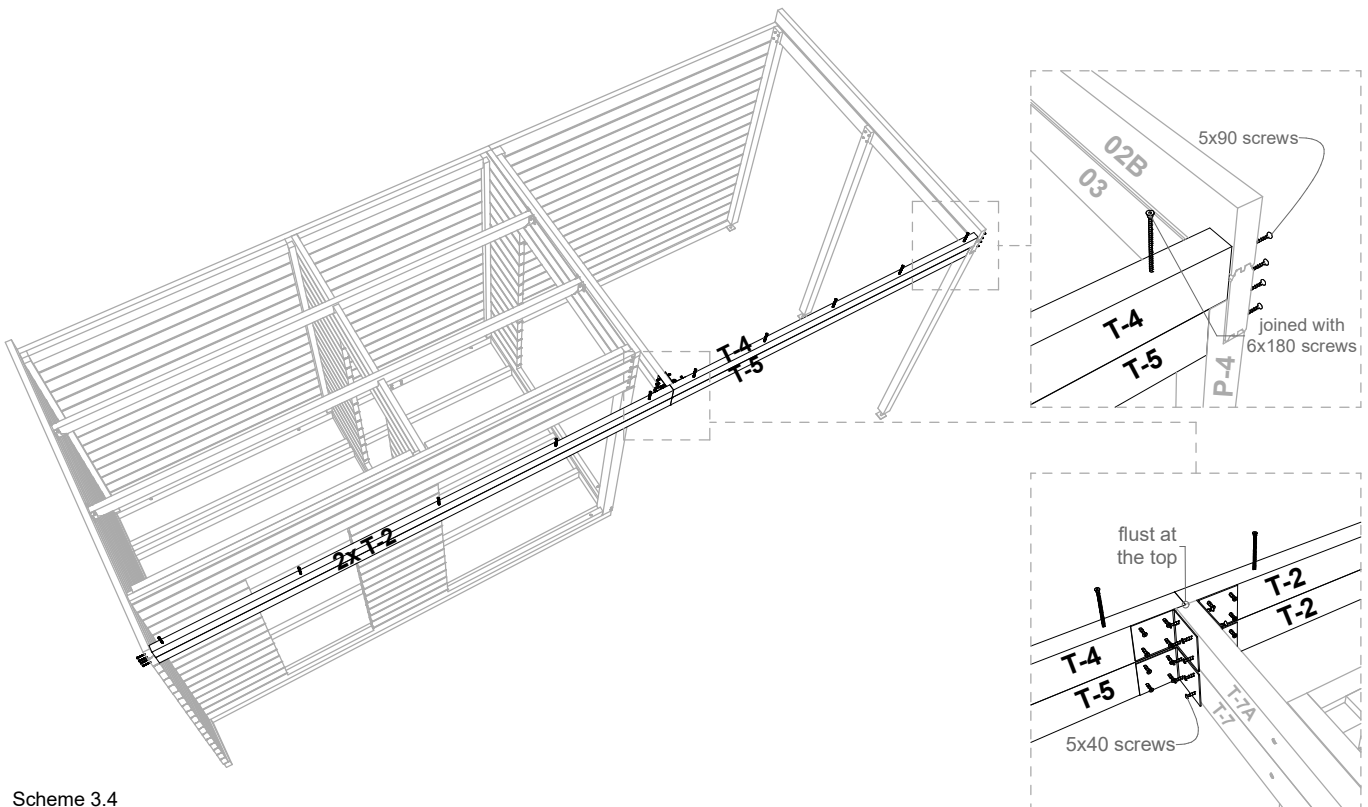

Scheme 3.4

STEP 3 - Roof boards and ceiling

3.9 Temporarily lay one KL-1 roof board or some other straight detail on top of the front and back walls of the shelter. Mark the diagonal that forms under the detail on the side walls with a pencil. These markings will determine the installation height of the T-1 ceiling beams. Measure out the distances and mark the locations on both side walls, like shown in Scheme 3.5. These markings will indicate the spacing between the T-1 ceiling beams.

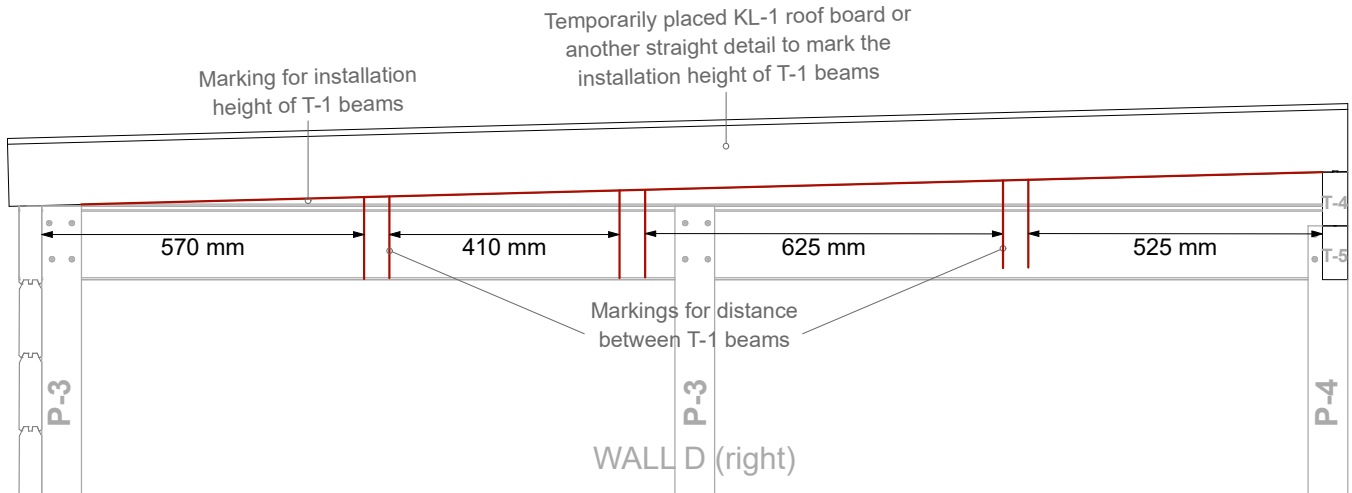

Scheme 3.5

3.10 Attach the 45x137 joist hangers to the T-1 ceiling beams with 5x40 screws, flush with the beams ends.



3.11 Fasten the T-1 ceiling beams to the side walls of the shelter through the joist hangers in the previously marked locations, like shown in Scheme 3.6. Use 5x40 screws to fix the joist hangers to the beams and walls.

3.12 Attach the T-6 beam to the back wall of the shelter. Leave ~2 mm gap at both ends. Make sure that the bottom side of the beam is flush with the bottom edge of the 03 wall log. Use 4.5x70 screws and a drill to fix the beam to the back wall (Scheme 3.1).

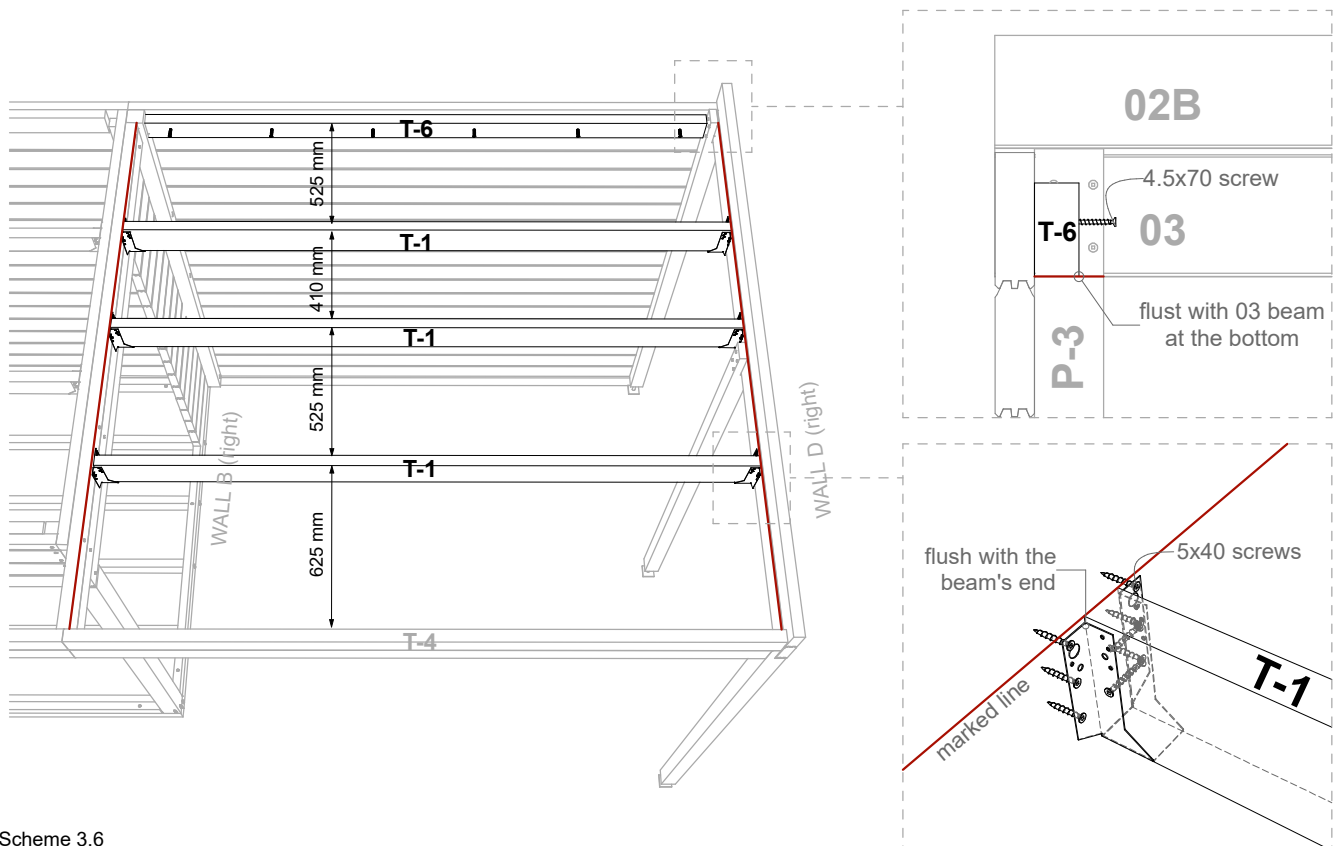

Scheme 3.6

STEP 3 - Roof boards and ceiling

3.12 Install the roof boards flush with the side walls, starting from the right. Fix the roof boards with 70 mm nails to the beams (8 nails per every roof board) using a hammer or a nail gun. Cut the last roof board to width using a circular saw.

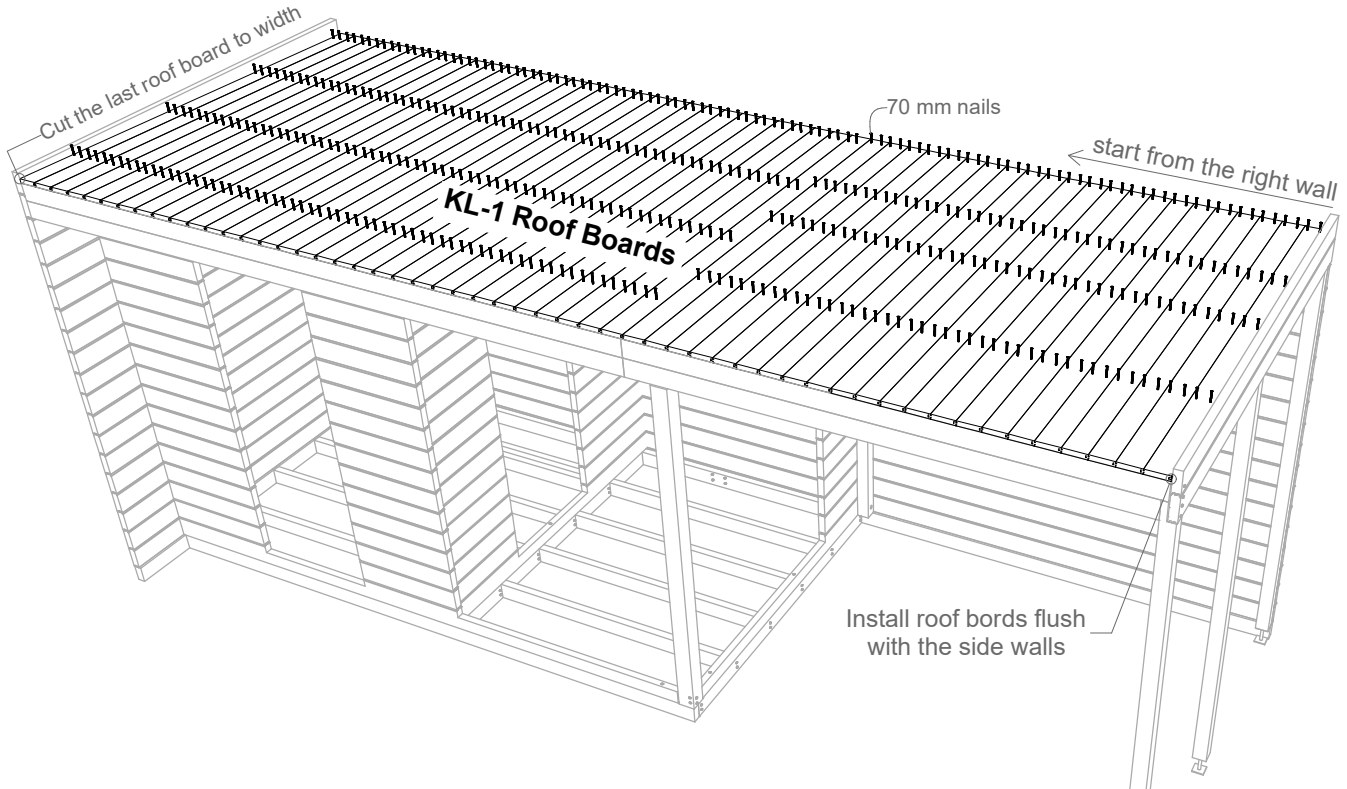

Scheme 3.7

3.13 When all the roof boards are installed, measure the distance from the roof boards to the bottom edge of the T-2 beam and mark it on Wall 2 (front). That line will indicate the installation height of the T-10 beam. Fix with 4.5x70 screws.



3.14 Install the 01F roof blocks on top of the roof boards, flush with the front edge. Fix with 4.5x70 screws (Scheme 3.8).

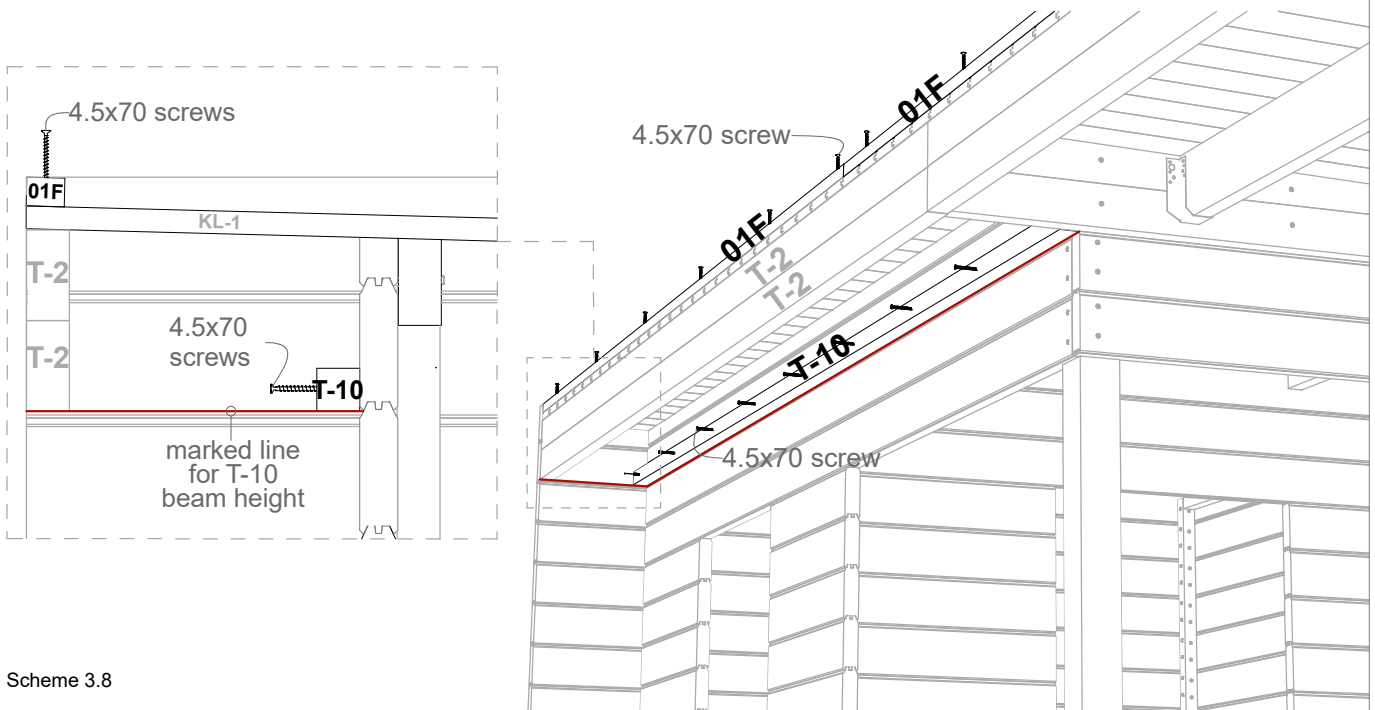

Scheme 3.8

STEP 3 - Roof boards and ceiling

3.15 Cut the SPU insulation panels to the right size using a cutting knife. Make cutouts in the corners for corner posts. Attach the panels to the ceiling beams using a few 4.5x70 screws. Tape all edges and joints with foil tape to prevent heat loss, like shown in Scheme 3.9.

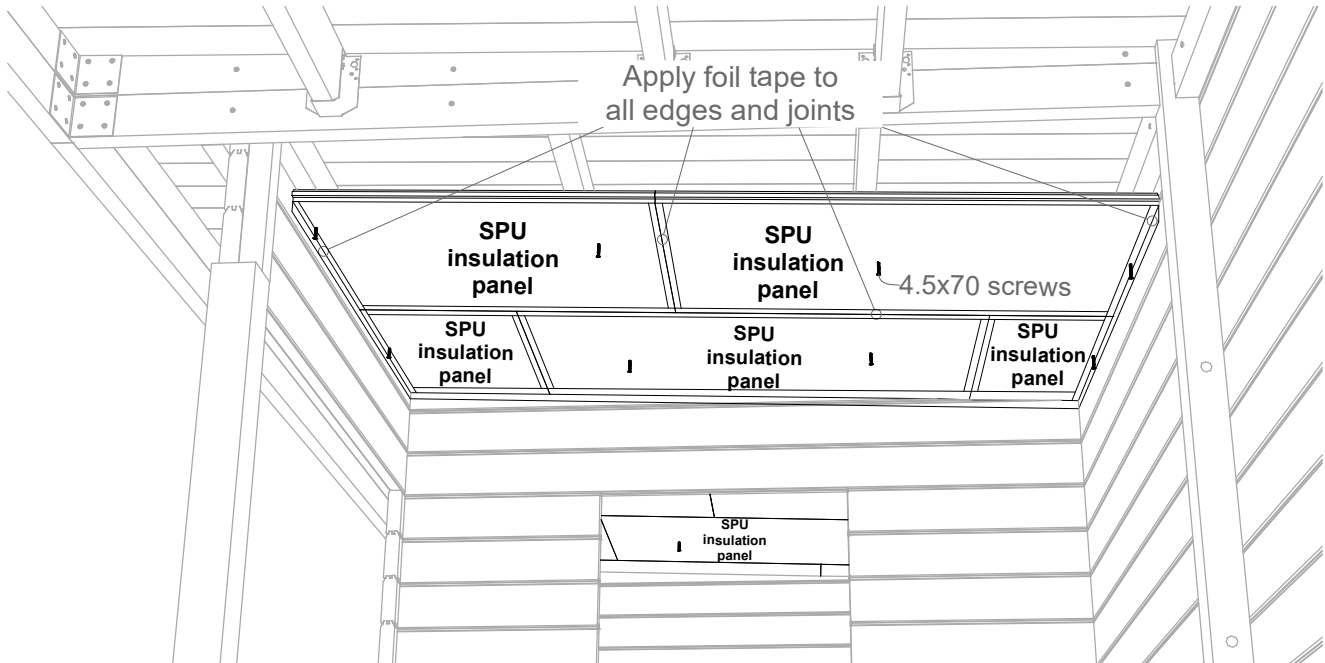

Scheme 3.9

3.16 Place the DI-2, DI-3, DI-4 and DI-5 ceiling distance boards on top of the insulation panels and fasten them to the ceiling beams using 4.5x70 screws.



3.17 Install the ceiling lining boards on top of the distance boards. Leave ~3 mm gap between the ceiling boards and walls on all sides. Use 40 mm lost-head nails (4 per every ceiling board) and a hammer or nail gun for fixing. Make corner cutouts in the first and last ceiling boards for corner posts with a hand saw, and cut the last ceiling board to width using a circular saw (Scheme 3.10).

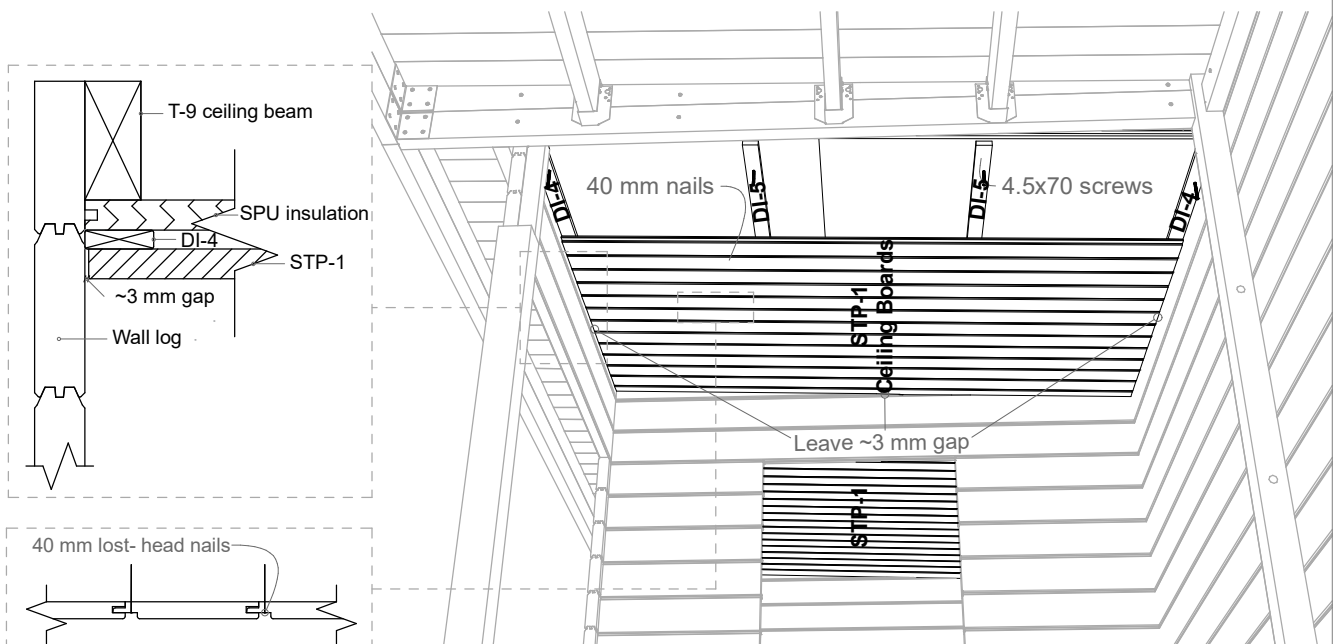

Scheme 3.10

STEP 4 - Floor

| Marking | Detail | Image | Note | Length | Pcs. |
|---------|--------------------------|-------|------|--------|------|
| | 3 mm Floor slope veneer | | | 1900 | 2 |
| | 6 mm Floor slope veneer | | | 1900 | 1 |
| | 9 mm Floor slope veneer | | | 1900 | 1 |
| | 12 mm Floor slope veneer | | | 1900 | 1 |
| PL-1 | 24x120 Floor Board | | | 1910 | 14+2 |
| PL-2 | 24x120 Floor Board | | | 1495 | 18+2 |
| PL-3 | 24x120 Floor Board | | | 385 | 18+2 |

| Marking | Detail | Image | Note | Length | Pcs. |
|---------|--------------|-------|------------------|--------|------|
| | Screw 3.5x50 | | for floor boards | | 210 |

4.1 Place the slope veneers on the base frame to give the floor a slope for water drainage. Fixing the details to the base frame with screws is optional (Scheme 4.1).

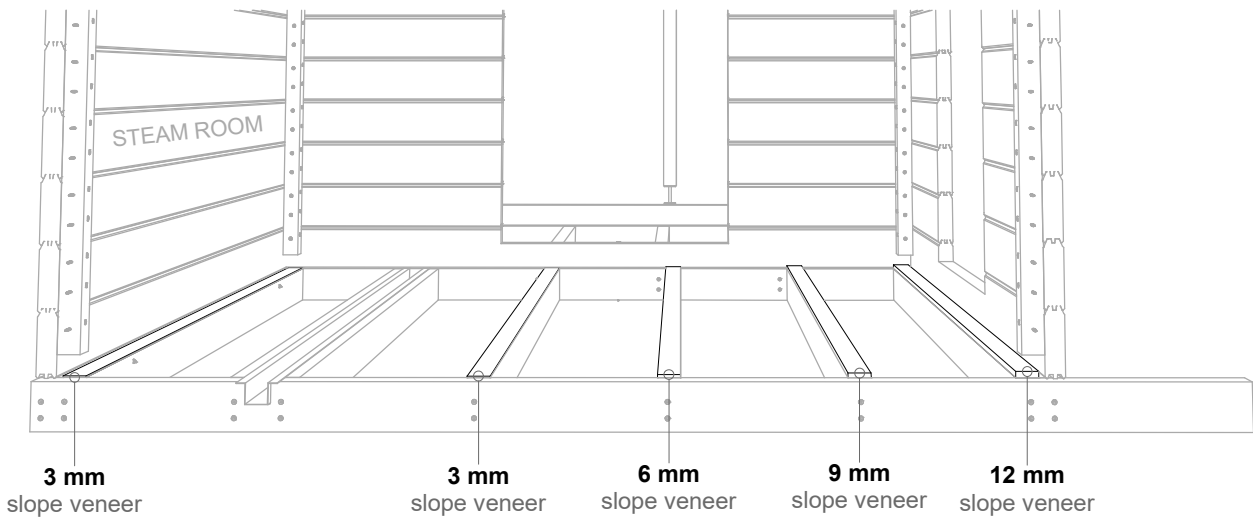

Scheme 4.1

4.2 Install the floor boards starting from the right. Leave ~3 mm gap between the floor boards and walls at all sides. Cut the last floor board to width using a circular saw. Use 3.5x50 screws to fix the floor boards in place (Scheme 4.2).

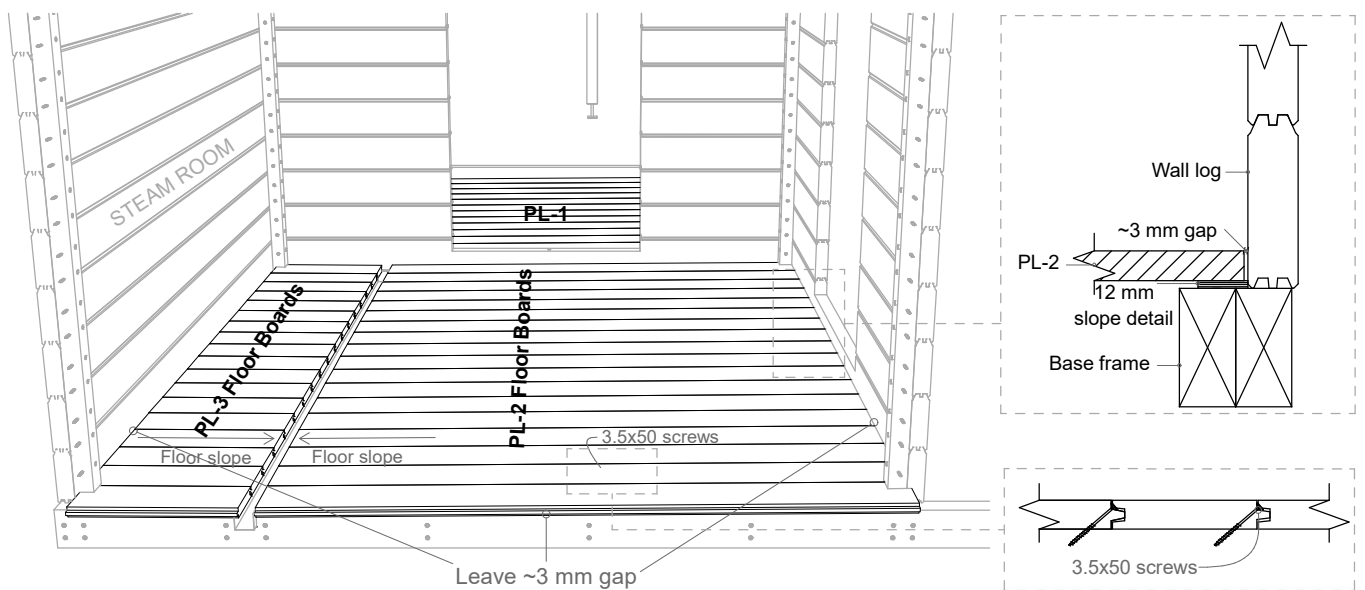

Scheme 4.2

STEP 5 - Doors and windows

| Marking | Detail | Image | Note | Length | Pcs. |
|---------|--------------------------|-------|----------------------------|--------|------|
| U-1 | Glass Door 88x690x1860 | | Metal + Metal door handle | | 1 |
| U-2 | Glass Door 88x690x1860 | | Metal + Wooden door handle | | 1 |
| A-1 | Window 88x690x1860 | | | | 4 |
| UR-1 | 45x45 Door/ Window frame | | | 1950 | 4 |
| UR-2 | 45x45 Door/ Window Frame | | | 1380 | 4 |
| UR-3 | 45x45 Window Frame | | | 690 | 2 |
| | Screw 4.5x70 | | for door and window frames | | 50 |
| | Screw 5x90 | | for door and window frames | | 10 |

5.1 Connect the windows and door together by attaching the UR-1, UR-2 and UR-3 frame details around them with 4.5x70 screws (Scheme 5.1).



Attention! When installing the window, make sure that the inclined frame is located indoors, at the bottom of the window. The bottom side is marked with a sticker.

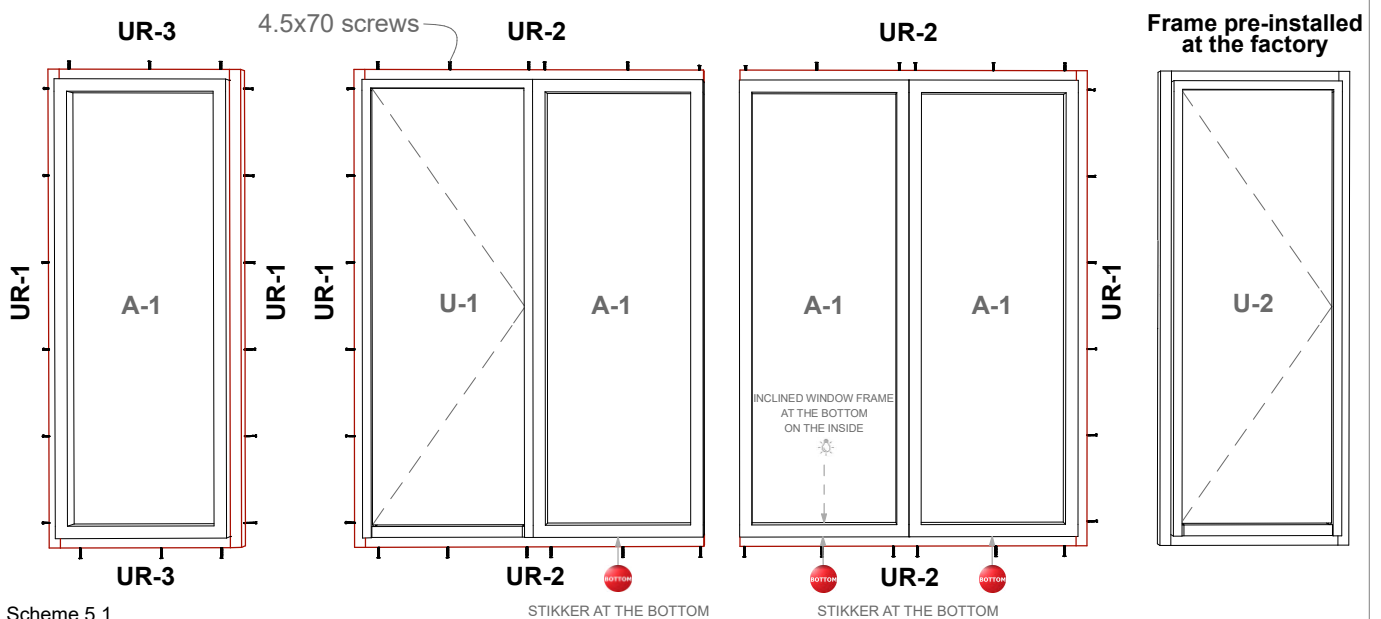

5.2 Lift and tilt the door and windows diagonally into the opening (Scheme 5.2). Place them to their positions from inside the sauna. For easier installation, remove the glass from the door hinges to reduce the weight of the door.

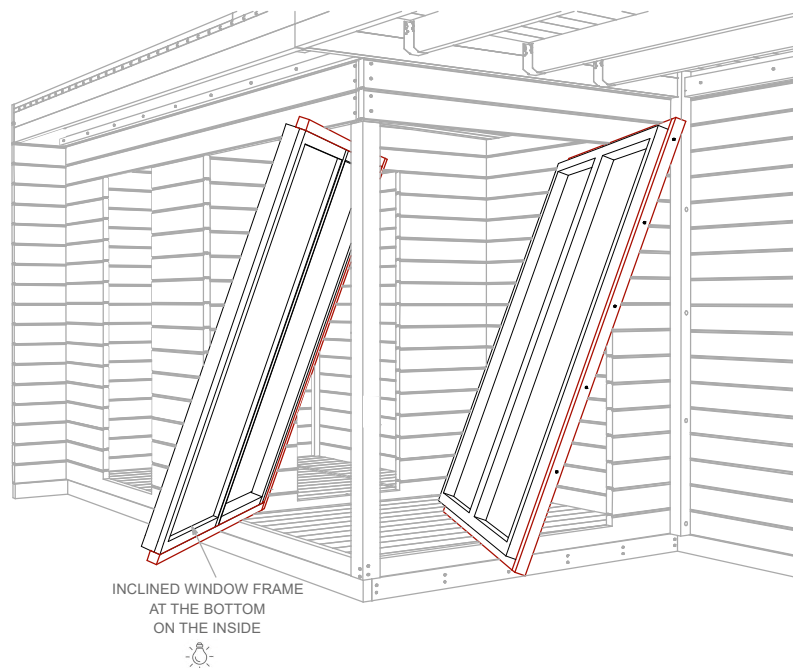

STEP 5 - Doors and windows

5.3 Fix the door and window frames to Wall 2 (front) and Wall B (right) from the outside using 4.5x70 screws (Scheme 5.3).



5.4 Fasten the windows to the P-0 corner post from inside the sauna, through the pre-drilled holes in the window frames. Use 5x90 screws. (Scheme 5.4). After fixing, cover all the pre-drilled holes with wooden cover caps. Attach the glass doors back to the hinges and fix the handles to the doors. The set includes two different handles that look the same but are made of different materials. Make sure that the outer door has a metal and metal handle and the inner door has a metal and wooden handle. A wooden handle must be installed on the inner door facing the steam room so that it does not heat up while using the sauna. The difference in material can be detected by sound (tap on the handles).

View from the inside:

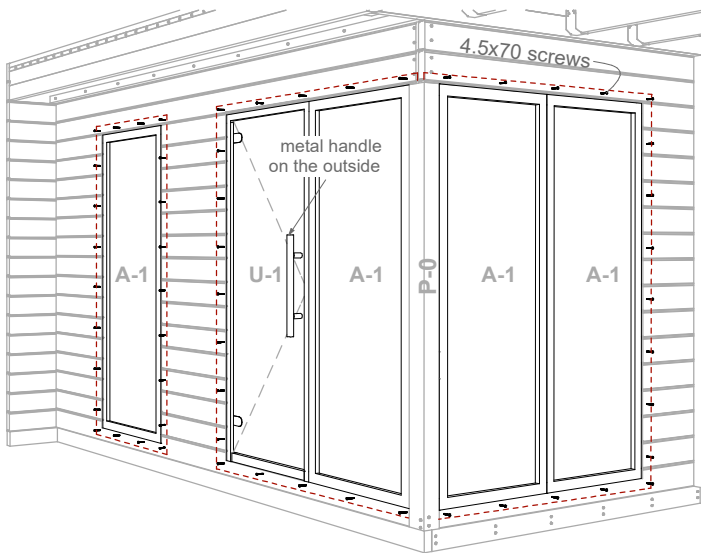

Scheme 5.3

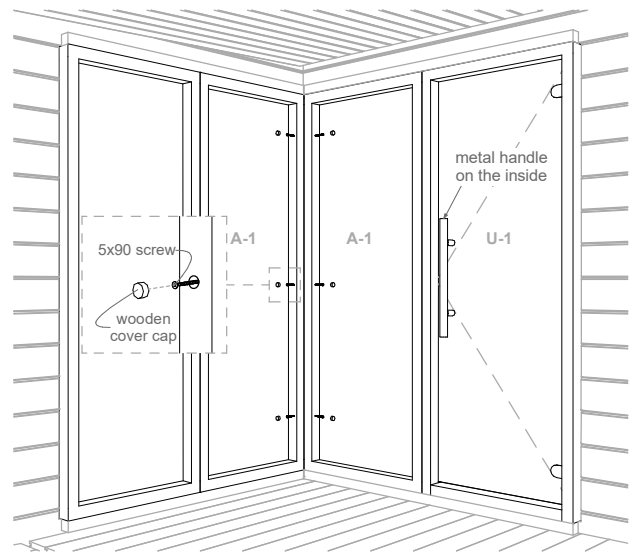

Scheme 5.4

STEP 6 - Ventilation

| Marking | Detail | Image | Note | Length | Pcs. |
|---------|------------------------|-------|-------|--------|------|
| U-2 | Ventilation Valve Ø100 | | wood | | 1 |
| U-3 | Ventilation Grid Ø100 | | metal | | 7 |
| | Screw 3x40 Black | | | | 24 |

6.1 Cut the ventilation holes in the walls with a diameter of 100 mm using a hole saw or a jigsaw. For recommended locations of ventilation openings see Scheme 6.1



Wall A (left)

View from the outside



Wall 1 (back)

View from the outside

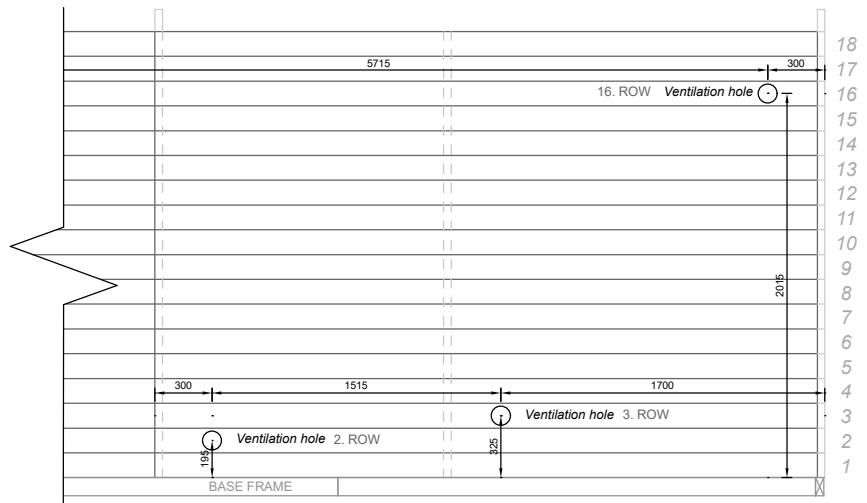

Scheme 6.1

STEP 6 - Ventilation

6.2 Cover the openings with ventilation grids or valves, as shown in Scheme 6.2. Use 3.5x40 black screws for fixing.

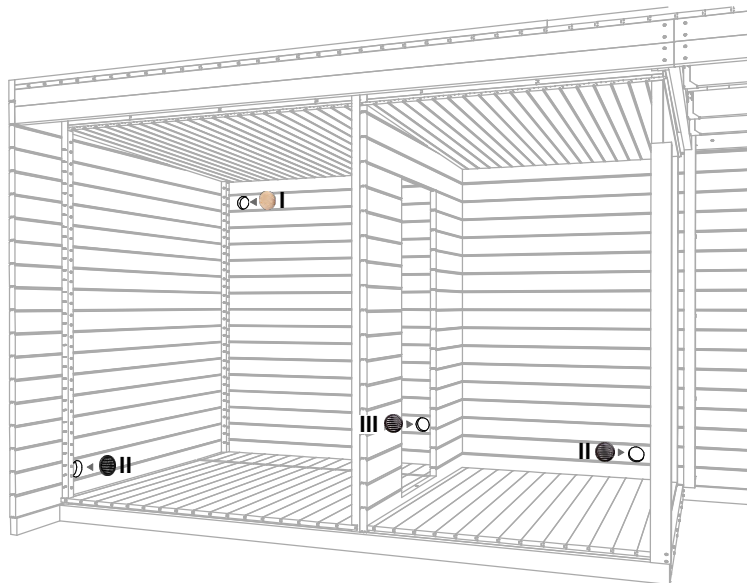

I - EXHAUST OPENING

Install the metal ventilation grid on the outside and the wooden valve on the inside.

The exhaust opening with the valve inside is located under the ceiling, and its purpose is to dry the steam room after using the sauna. The ventilation valve should be closed while using the sauna. Open the valve after using the sauna to expel excess moisture through the opening.

For faster drying, leave the steam room door ajar after a sauna session.

The ventilation valve can also be opened between steam sessions if there are many people in the steam room at the same time and excessive humidity or a lack of air occurs.

II - INLET

Install a metal ventilation grid inside and outside.

III - OUTLET

Install a metal ventilation grid inside and outside.

Scheme 6.2

STEP 7 - Grid walls, outer lining and moldings

| Marking | Detail | Image | Note | Length | Pcs. |
|---------|---------------------------------------|-------|---------------------|--------|------|
| VS-1 | Grid Wall 1047 mm | | | 2125 | 2 |
| DI-1 | 15x55 Distance Board for Outer Lining | | | 2250 | 2 |
| DI-6 | 9 mm Distance Veneer | | for shelter ceiling | ~2410 | 3 |
| DI-7 | 12 mm Distance Veneer | | for shelter ceiling | ~2410 | 1 |
| STP-2 | 14x121 Shelter Ceiling Lining Board | | | 2310 | 23+2 |
| STP-3 | 14x121 Outer Lining Board | | | 350 | 51+2 |
| L-0 | 18x120 Corner Post Molding | | Cut to length! | 2240 | 2 |
| L-1 | 18x95 Roof Molding | | Cut to length! | ~3500 | 3 |
| EXTRA | 18x95 Roof Molding | | | ~3500 | 1 |
| L-2 | 18x95 Corner Molding | | Cut to length! | ~2650 | 3 |
| L-3 | 18x95 Roof Molding | | Cut to length! | ~2500 | 2 |
| L-4 | 18x95 Corner Molding | | Cut to length! | ~2400 | 7 |
| L-5 | 18x95 Corner Molding | | Cut to length! | ~2200 | 4 |
| UL-1 | 18x95 Door/ Window Molding | | | 1925 | 4 |
| UL-2 | 18x95 Door/ Window Molding | | | 1478 | 1 |
| UL-3 | 18x95 Door/ Window Molding | | | 1460 | 1 |
| UL-4 | 18x95 Door/ Window Molding | | | 1358 | 1 |
| UL-5 | 18x95 Door/ Window Molding | | | 1340 | 1 |
| UL-6 | 18x95 Door/ Window Molding | | | 910 | 1 |
| UL-7 | 18x95 Door/ Window Molding | | | 670 | 1 |
| UL-8 | 15x55 Door/ Window Molding | | | 1830 | 2 |

| Marking | Detail | Image | Note | Length | Pcs. |
|---------|----------------------------|-------|----------------------------------|--------|------|
| | Transparent silicone | | for all outside corners | | 1 |
| | Moisture safety tape | | for all outside corners | 10 m | 1 |
| | Screw 3x40 Black | | for distance boards and moldings | | 250 |
| | Lost-head nail 40 mm | | for outer lining boards | | 400 |
| | Screw 4.5x70 | | for grid walls | | 32 |
| | Teknos Aqua Primer - Black | | | | 1 |

STEP 7 - Grid walls, outer lining and moldings

7.1 Seal the outside corners of the sauna with transparent silicone, as shown in Scheme 7.1. to prevent moisture and rainwater from entering the sauna.

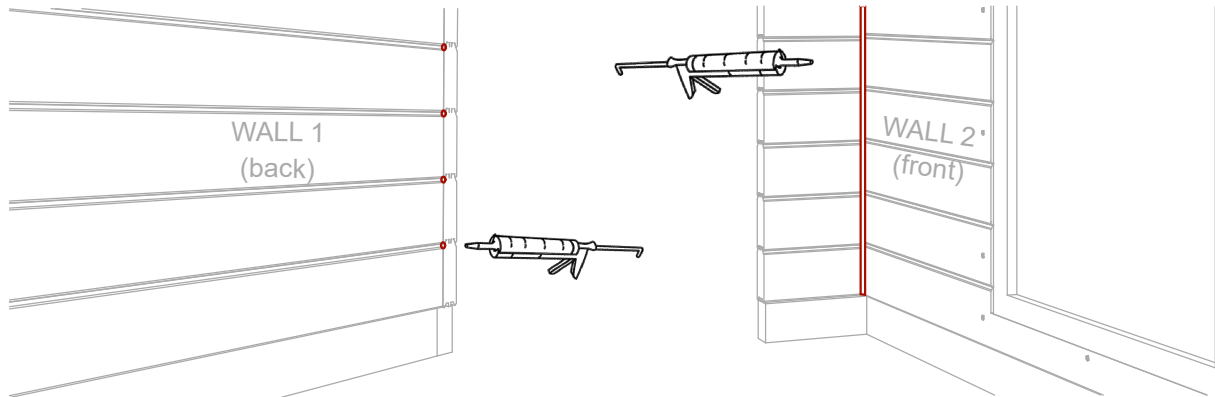

Scheme 7.1

7.2 For extra protection, tape all outside corners of the sauna with moisture safety tape before installing exterior moldings (Scheme 7.2).

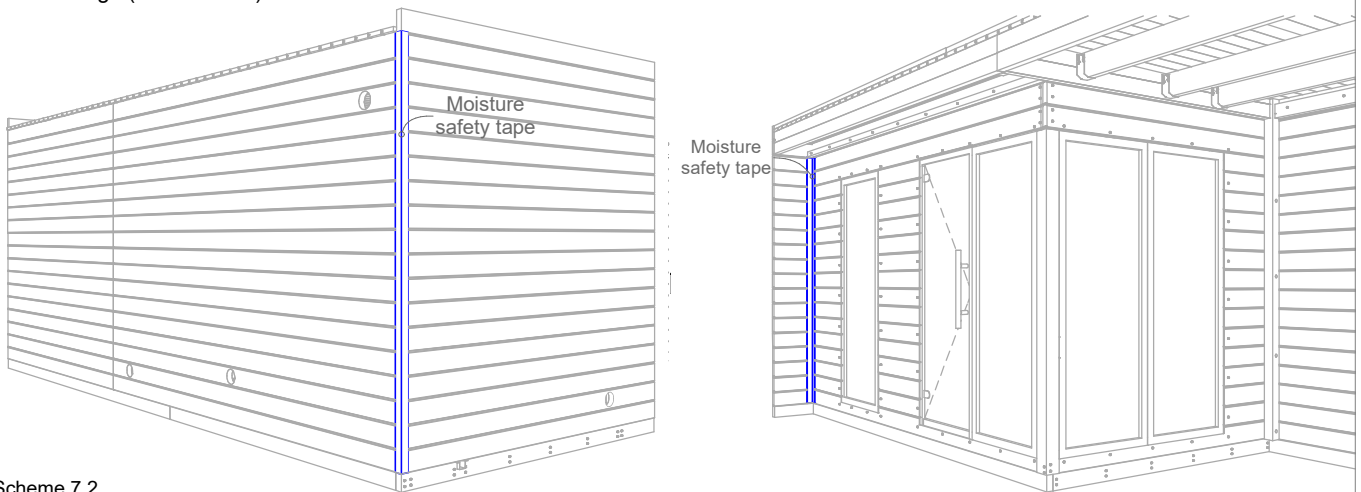

Scheme 7.2

7.3 Measure the height of the protruding parts of the side walls and cut the DI-1 distance boards to the correct length if necessary. Attach the distance boards to the walls using 3x40 screws.

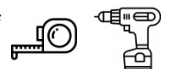

7.4 Install the STP-3 outer lining boards on top of the DI-1 distance boards and ceiling beams, starting from the bottom. Cut the last lining board to the correct width. Use 40 mm lost-head nails for fastening (2 nails per board). See Scheme 7.3.

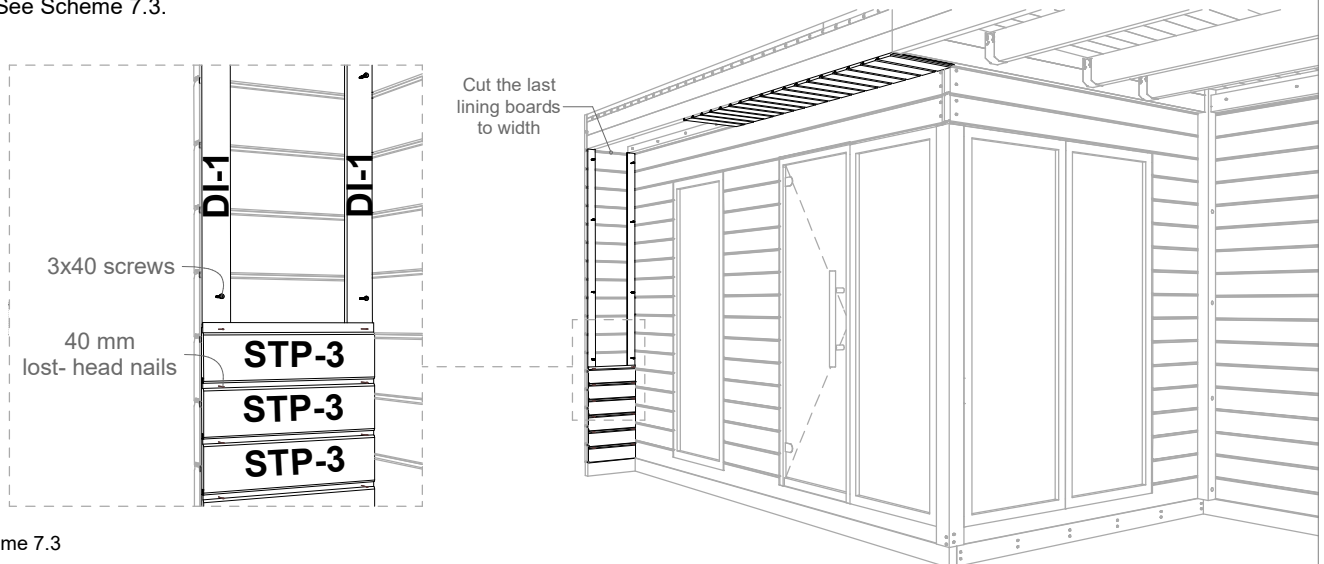

Scheme 7.3

STEP 7 - Grid walls, outer lining and moldings

7.5 Place the DI-6 and DI-7 distance veneers on the T-1 ceiling beams according to Scheme 7.4 and fasten them to the with 4.5x70 screws.

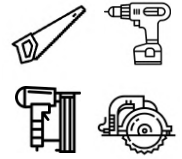

7.6 Install the ceiling lining boards on top of the distance veneers. Use 40 mm lost-head nails (5 per every ceiling board) and a hammer or nail gun for fixing. Cut the last ceiling board to width using a circular saw and make cutouts for support posts with a hand saw.

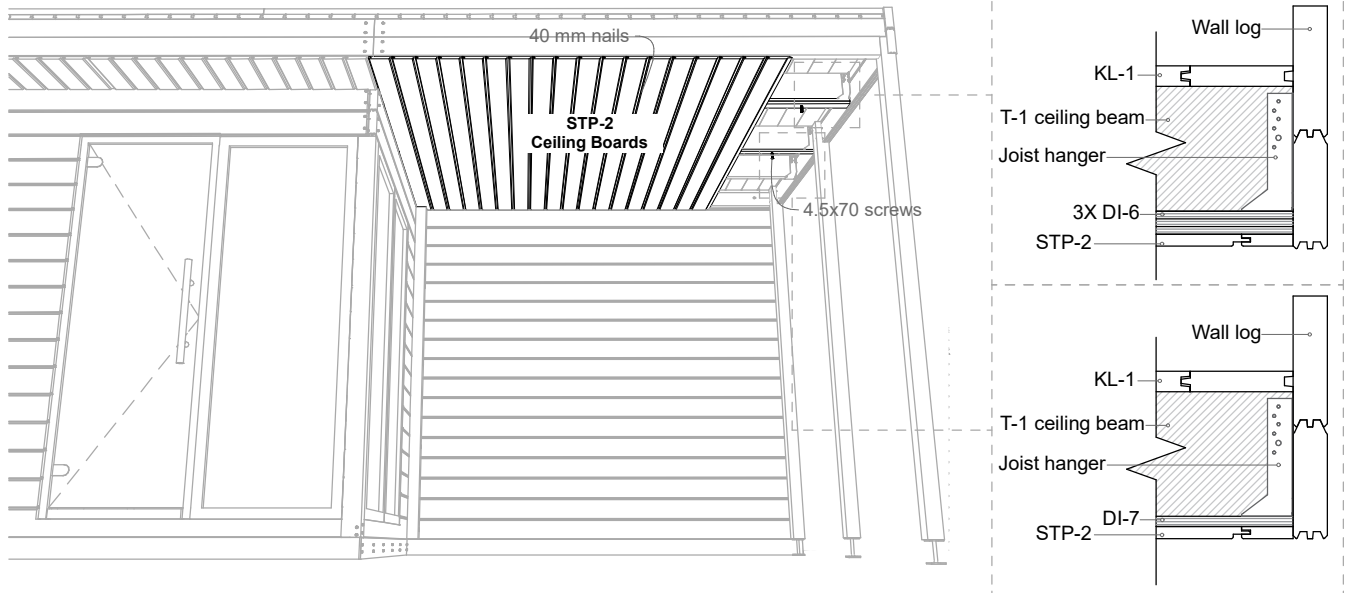

Scheme 7.4

7.7 Place the grid walls between the support posts. Leave a 20 mm gap at the top and fasten the grid walls to support posts with 4.5x70 screws as shown in Scheme 7.5.

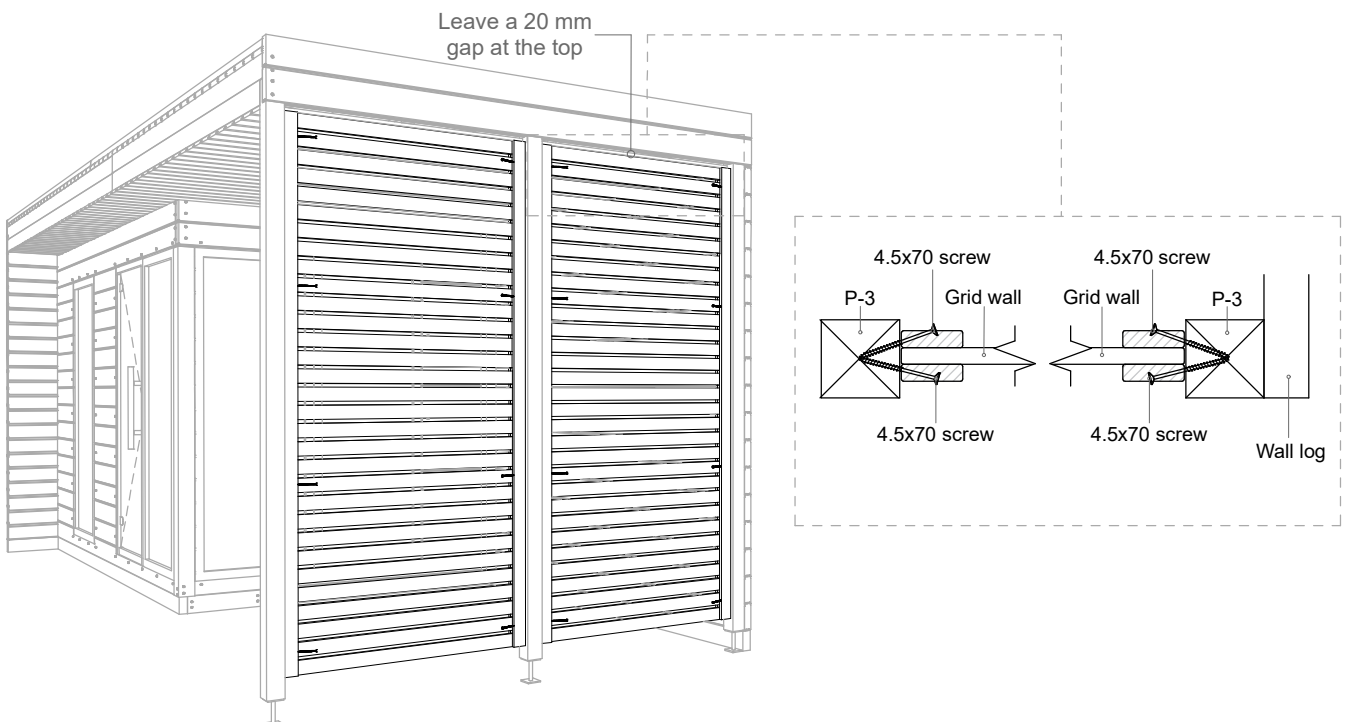

Scheme 7.5

STEP 6 - Outer lining and moldings

- 6.4 First, fix the L-4 roof moldings to the side walls. The moldings must be installed flush with the upper edges of the side walls. Cut the moldings to length and fasten them with 3x40 black screws.
- 6.5 Next, fasten the L-1 roof moldings, measure and cut the L-2 roof moldings to length and fix them to the roof beams.
- 6.6 Make corner cutouts in L-3 corner moldings as marked in Scheme 6.3. Cut to length and use 3x40 black screws to fasten all the other corner moldings.

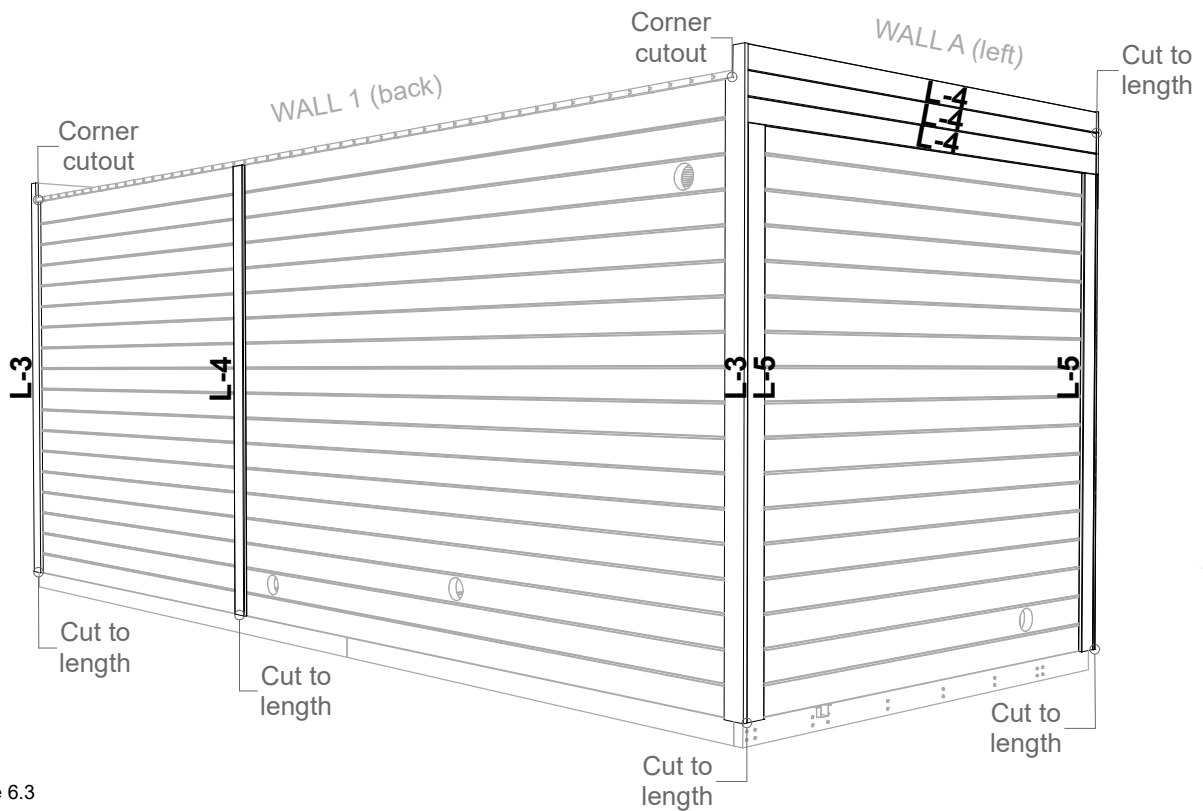
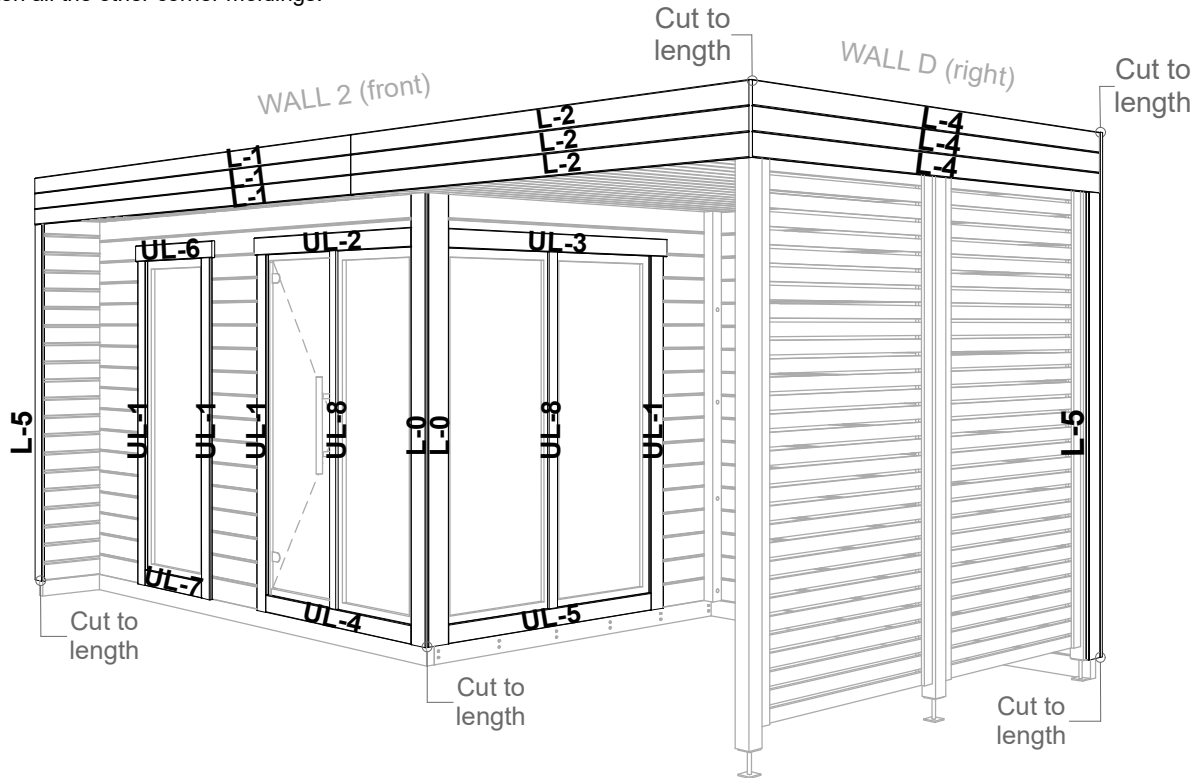
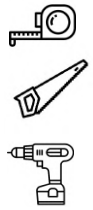

Scheme 6.3

STEP 6 - Outer lining and moldings

6.7 Install the moldings around the door and windows using 3x40 black screws.
For the correct overlay, see Scheme 6.4.

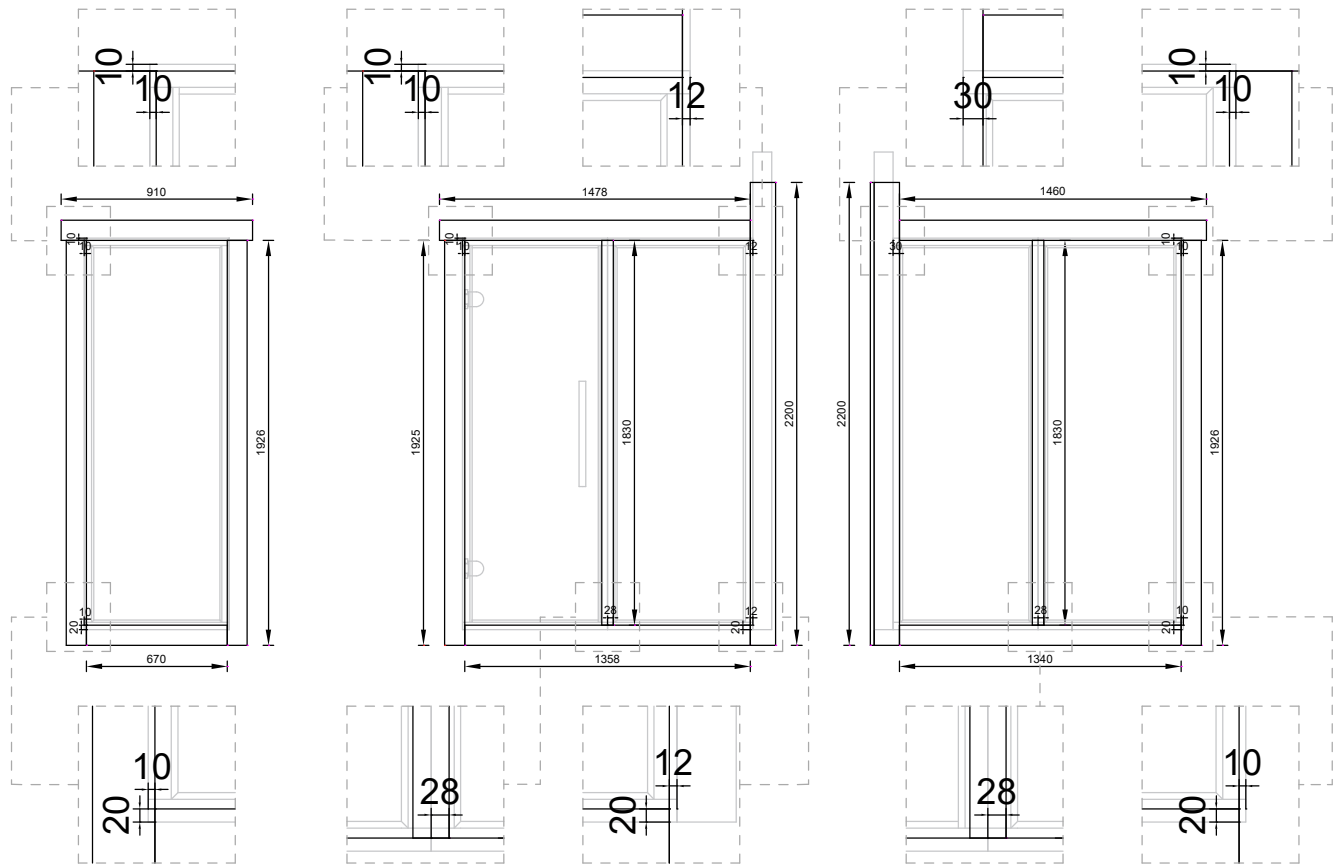

Scheme 6.4

6.8 Paint over all cut ends of the moldings with black Teknos Aqua Primer.
Scan the QR code for more detailed product information.



STEP 8 - Sauna benches

| Marking | Detail | Image | Note | Length | Pcs. |
|---------|------------------------------------|-------|----------------------------|--------|------|
| | Bench Module 600 mm | | Top - Wall A (left) | 1793 | 1 |
| | Bench Module 500 mm | | Bottom - Wall A (left) | 1793 | 1 |
| | Bench Module 500 mm | | Top - Wall 1 (back) | 1320 | 1 |
| | Bench Module 600 mm | | Bottom - Wall 1 (back) | 937 | 1 |
| | Bench Module 400 mm | | Anteroom - Wall 1 (back) | 1467 | 1 |
| | Bench Skirt | | | 1793 | 1 |
| | Bench Horizontal Support Set 45x45 | | | | 1 |
| | Bench Side Frame | | Includes 3 adjustable legs | | 1 |
| | Extra Vertical Support | | Includes 1 adjustable legs | | 1 |
| Marking | Detail | Image | Note | Length | Pcs. |
| | Screw 4.5x70 | | for all supports | | 100 |

STEP 8 - Sauna benches

8.1 Measure the length of the sauna bench and mark the location of the vertical frame. Adjust the height of the side frame through the adjustable legs. Fix the frame to Wall A (left) using 4.5x70 screws, like shown in Scheme 8.1.

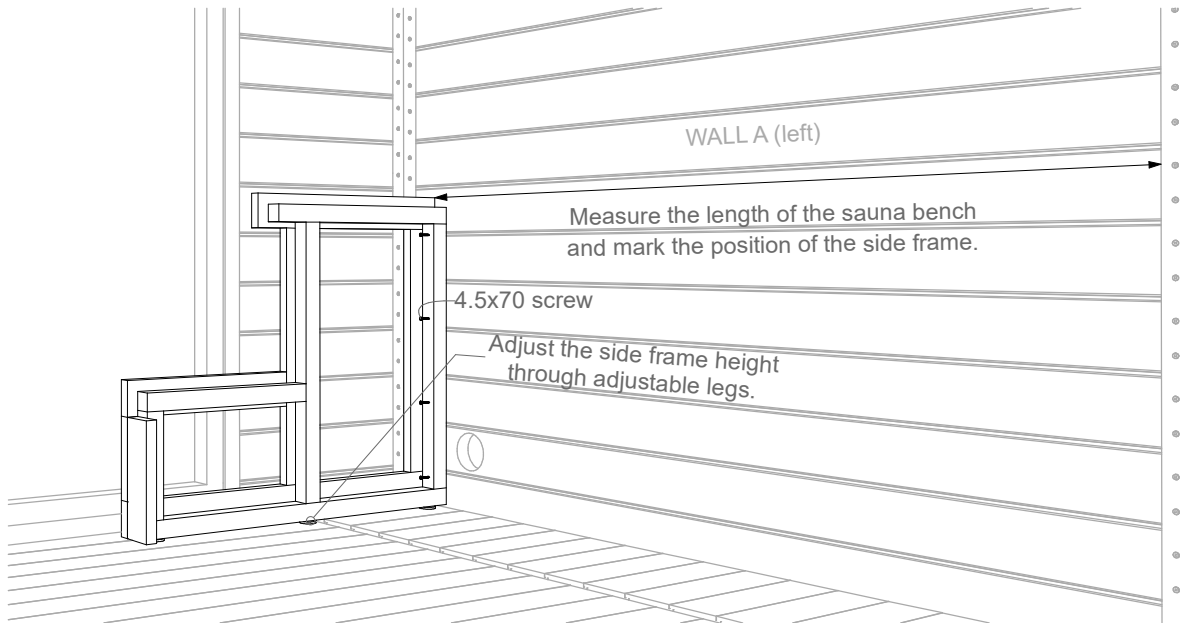
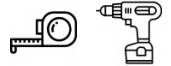

Scheme 8.1

8.2 Measure the distance and fix the upper and lower bench supports to the walls according to Scheme 8.1. Use 4.5x70 screws.

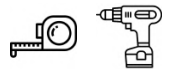

It is recommended to additionally use glue (not included) for fixing the sauna bench supports to the wall.

View from the front:

View from the side:

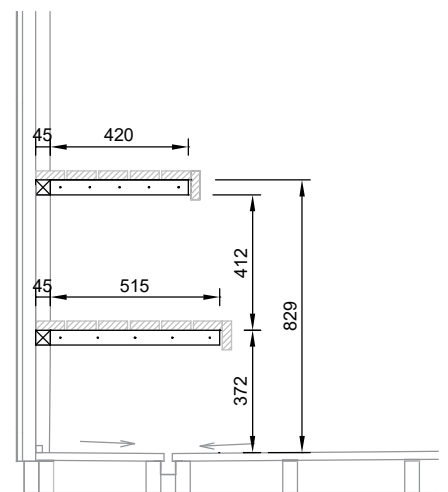
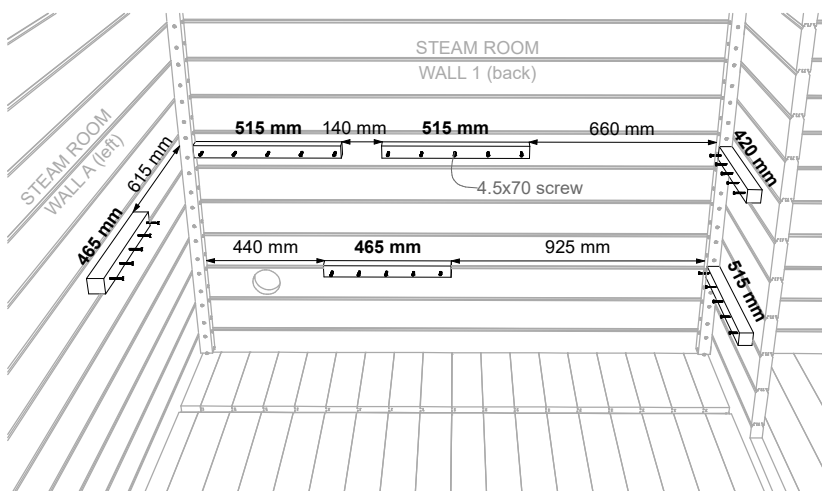

Scheme 8.2

STEP 8 - Sauna benches

8.3 Lift and place the bottom benches on top of the supports. If LED lighting under the sauna benches has been ordered additionally (not included in the standard set), install the LED strips under the benches before placing them on top of the supports. More detailed instructions are included with the lighting details.

8.4 Set the bench skirt in place. Leave a 8 mm gap between the skirt and the lower bench. Fix the skirt side frames to the side wall and the side frame and the middle frame to the bottom bench, using 4x70 screws. See Scheme 8.3

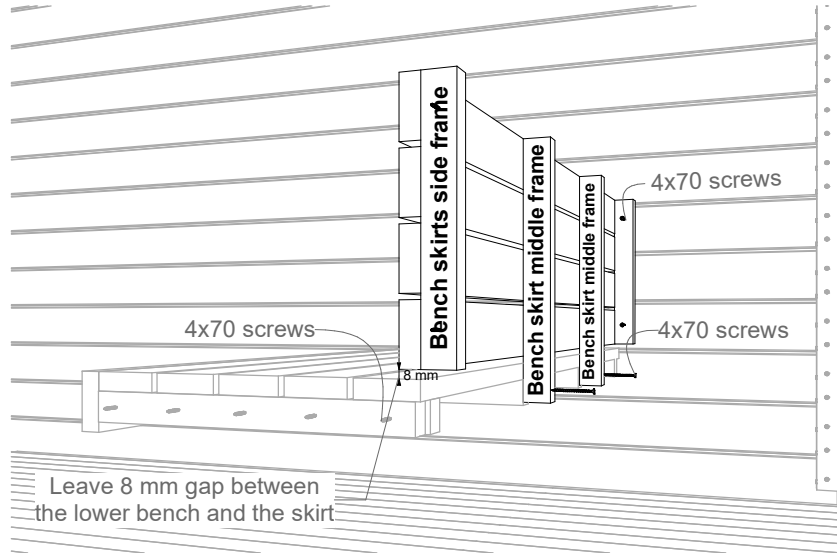

Scheme 8.3

8.5 Measure the distance and fix the bench supports to the walls in the anteroom, according to Scheme 8.4. Use 4.5x70 screws for fixing. It is recommended to additionally use glue (not included) for fixing the sauna bench supports to the wall.

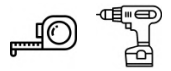

View from the front:

View from the side:

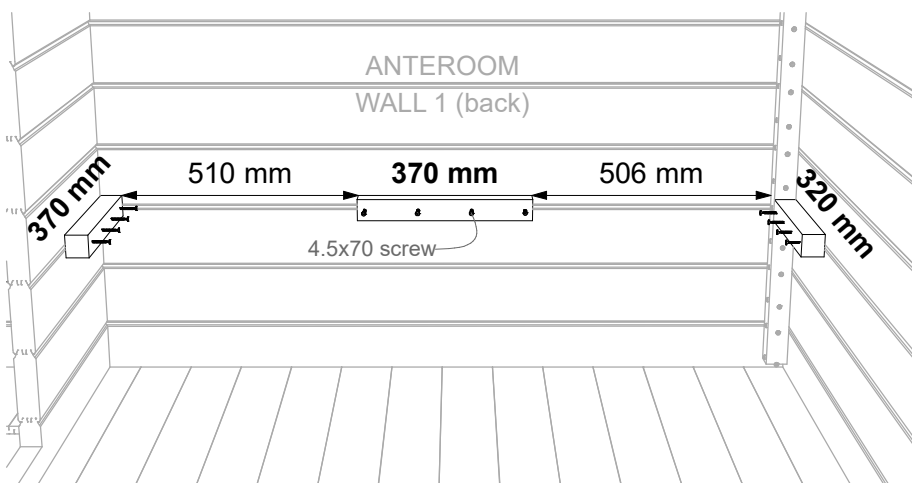

Scheme 8.4

STEP 8 - Sauna benches

8.6 Attach the horizontal support for the back wall benches to the left wall benches using 4.5x70 screws.



8.7 Lift and place the benches on top of the supports. Leave ~4 mm gap between the benches and the walls. Fix all the benches to the supports through the bench's bottom frame, using 4.5x70 screws. Do not fully tighten the screws. See Scheme 8.5.

8.8 If needed, place the extra vertical support under the top benches and fix it in place. Adjust the height of the support through the adjustable leg at the bottom.

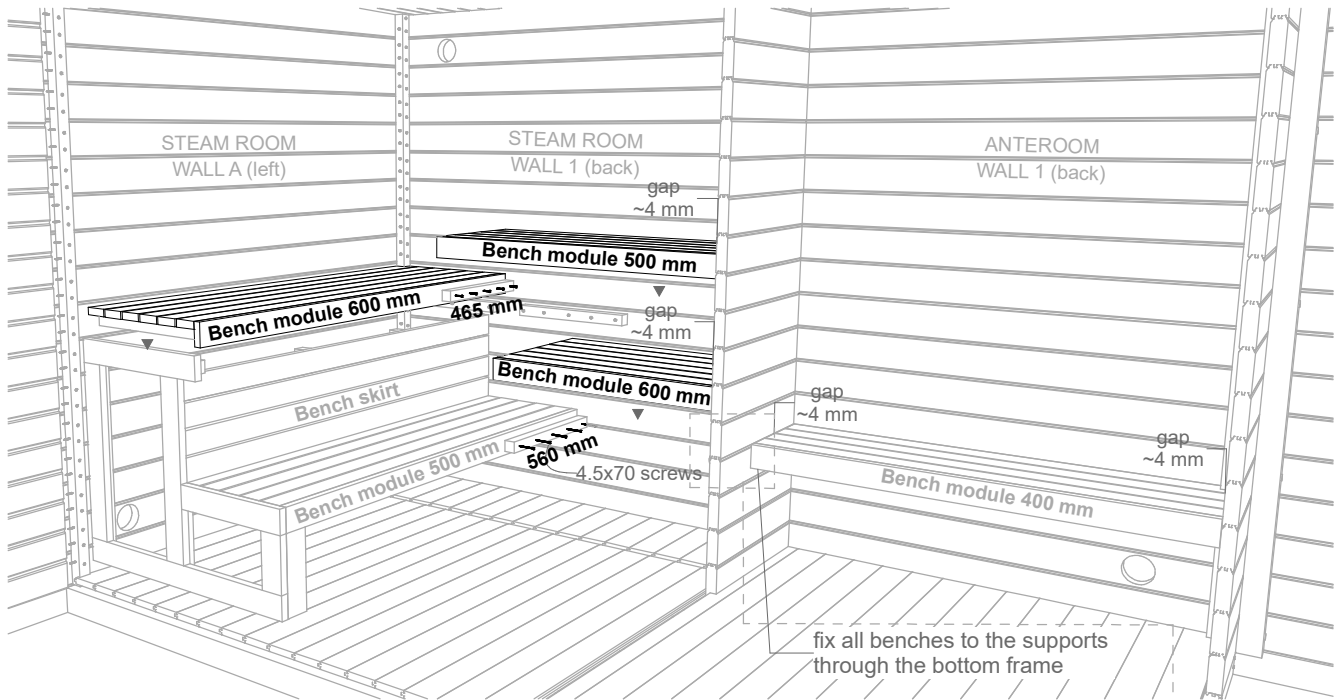

Scheme 8.5

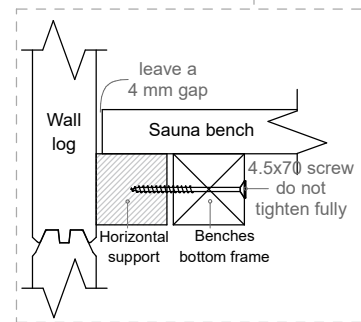

STEP 9 - Interior moldings

| Marking | Detail | Image | Note | Length | Pcs. |
|---------|---------------------------------|-------|-----------------------|--------|------|
| DI-0 | 50X50 Corner Post Molding | | <i>Cut to length!</i> | 2100 | 5+1 |
| DI-00 | 21x21 Ceiling and Floor Molding | | <i>Cut to length!</i> | 2100 | 14 |
| SL-1 | Interior Door Molding | | | 1955 | 2 |
| SL-2 | Interior Door Molding | | | 670 | 2 |
| VL-1 | Exterior Door Molding | | | 1425 | 1 |

| Marking | Detail | Image | Note | Length | Pcs. |
|---------|----------------------|-------|---------------------------|--------|------|
| | 40 mm lost-head nail | | for all interior moldings | | 300 |

STEP 9 - Interior moldings

9.1 Measure and cut to length all DI-0 corner post moldings with a handsaw.

Install DI-0 corner molding on top of the corner posts, under, between, and above the sauna benches like shown in Scheme 9.1. Fasten the moldings with 40 mm lost-head nails, using a nail gun or a hammer.

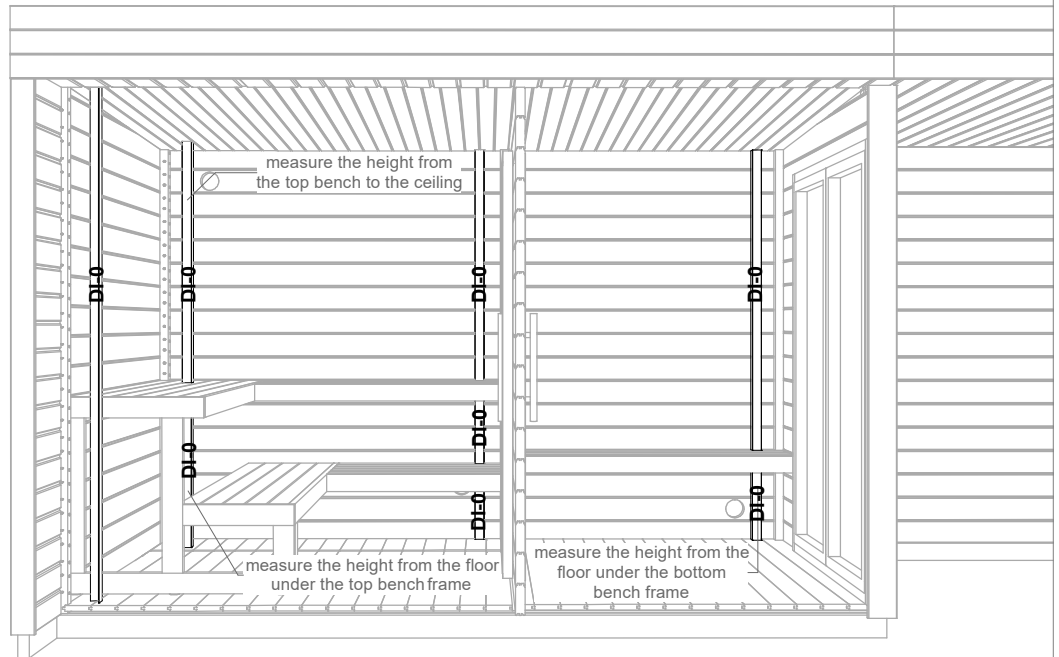
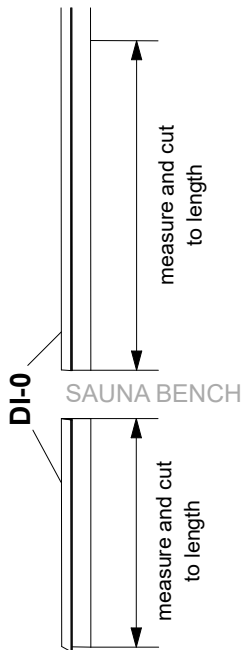

Scheme 9.1

9.2 Install the interior door moldings around the U-2 door in the anteroom with 40 mm lost-head nails. Scheme 9.2.

9.3 Seal the gap under the exterior door with silicone and fasten the VL-1 molding on the inside using 40 mm lost-head nails (Scheme 9.3).

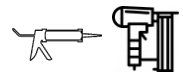

9.4 Measure and cut to length all DI-00 ceiling and floor moldings and fasten them with 40 mm lost-head nails. Use a nailgun or a hammer (Scheme 9.3).

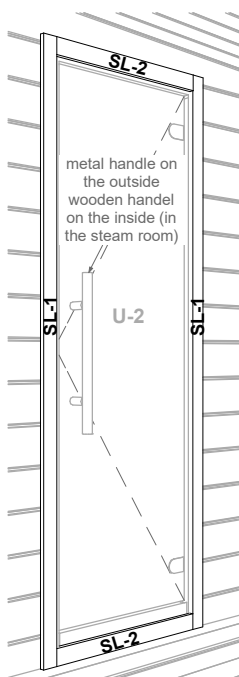



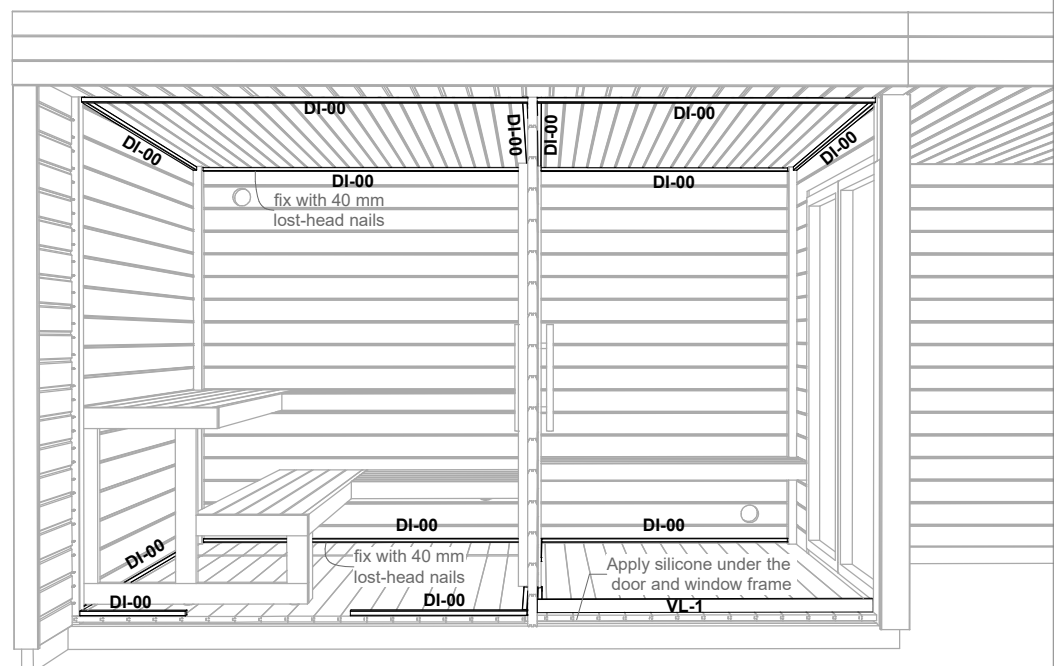

Scheme 9.2



Scheme 9.3

STEP 10 - Roof covering and moldings

| Marking | Detail | Image | Note | Length | Pcs. |
|---------|--------------------------------------|---|--|--------------------|--------|
| | EPDM Rubber Roof Cover 6.3x3.05 m |  | | | 1 |
| | EPDM Glue |  | 2.5 l | | 2 |
| | EPDM Quickprime |  | 250 ml | | 1 |
| | Paint roller + Handle | | | | 1 |
| | Metal roofing sheet |  | for back wall <i>Cut to length!</i> | 2050 mm | 3 |
| | Metal roofing sheet |  | for front wall. <i>Cut to length!</i> for side walls. <i>Cut to length!</i> | 2100 mm 2750 mm | 3 2 |

| Marking | Detail | Image | Note | Length | Pcs. |
|---------|----------------------------|---|-------------------------------------|--------|------|
| | Black Wronic Screw 4.2x25 | | for back wall metal roofing sheet | | 30 |
| | Black Roofing Screw 4.8x25 | | for side walls metal roofing sheets | | 50 |
| | Splice Tape |  | for back wall metal roofing sheet | 6 m | 1 |

- 10.1 Clean the roof surface from dirt, dust, ice, snow, water, etc.
- 10.2 Cut the back wall metal profile to length with sheet metal scissors. Leave a 1 mm gap on both sides. Attach the back profile to the roof boards on the back wall using 4.2x25 black Wronic screws.
- 10.3 Check the EPDM roof cover for defects before installing. Put the rubber roof cover in position and check for the correct overhang (Image 1).
- 10.4 Fold and roll the rubber roof cover, and start applying the glue to the roof boards and the rubber surface one half at a time. (Image 2). Apply glue in a well-ventilated area. Use gloves, safety goggles, and a respirator.
- 10.5 **Important!** Wait until the glue is "touch dry" (approximately 15 minutes or longer) before folding the rubber in place. Waiting for the glue to dry is necessary to prevent the rubber from bubbling after it is set in place.
- 10.6 Apply Quickprime + glue on top of the back metal profile and rubber. Then apply the double-sided splice tape on top of the metal profile (Scheme 10.1).
- 10.7 Remove the top side of the splice tape and apply the glued rubber on top of the tape. Fold the rubber roof cover in place. Avoid air bubbles and wrinkles on the surface (Image 3).
- 10.8 Smooth the roof cover with a broom or a brush and cut off the excess rubber (Image 4).



Image 1



Image 2

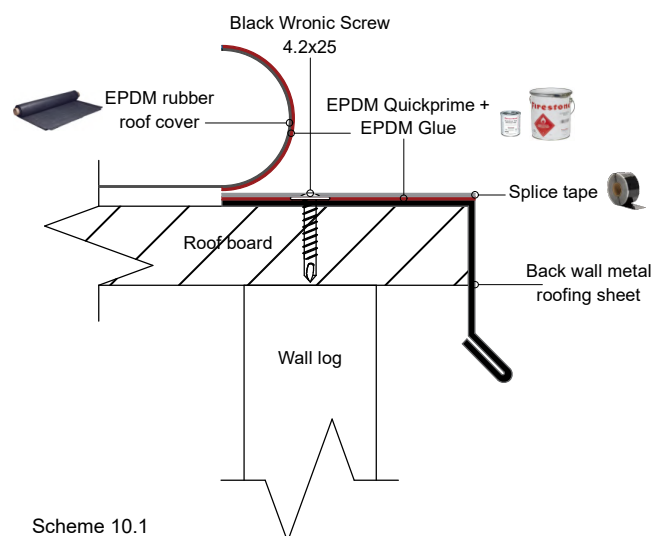

Image 3



Image 4

Back wall metal roofing sheet:



STEP 10 - Roof covering and moldings

- 10.9 Cut 58 mm off the side metal profiles at one end, like shown in Scheme 10.2. Use sheet metal scissors, pliers and protective gloves to prepare metal roofing sheets for installation.
- 10.10 Cut 68 mm off the front metal profile at both ends, like shown on Scheme 10.2.
- 10.11 Fit the front metal roofing sheet on top of the side metal roofing sheets with ends overlapping, like shown in Scheme 10.4.

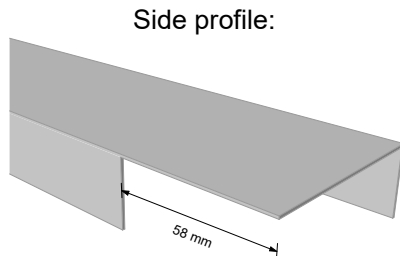

Scheme 10.2

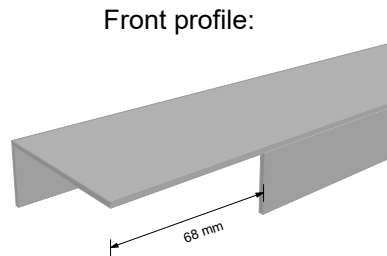

Scheme 10.3

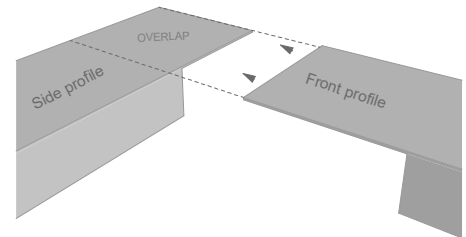

Scheme 10.4

- 10.12 Use 4.8x25 black roofing screws to fix the profiles to walls at the sides and the roof block at the front (Schemes 10.5 and 10.6).

Front wall metal roofing sheet:

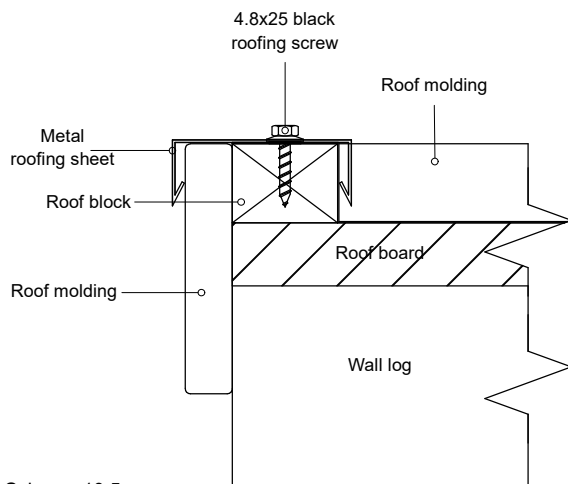

Scheme 10.5

Side wall metal roofing sheet:

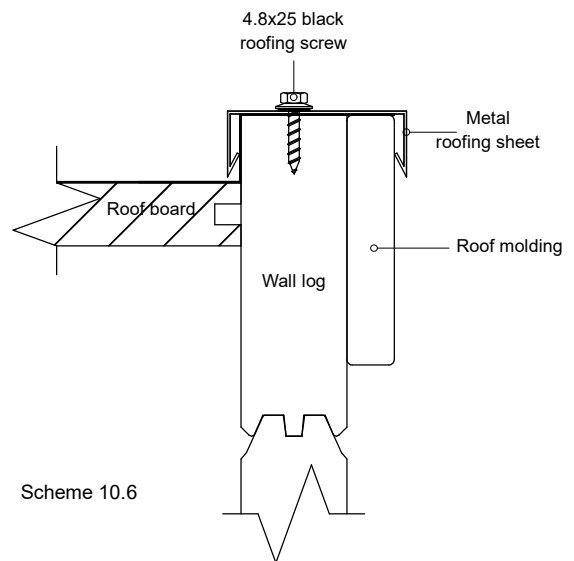

Scheme 10.6

- 10.13 At the back wall, cut and fold the excess metal roofing sheet 90 degrees downward (Scheme 10.7). Fix with 4.8x25 roofing screws (Image 6).

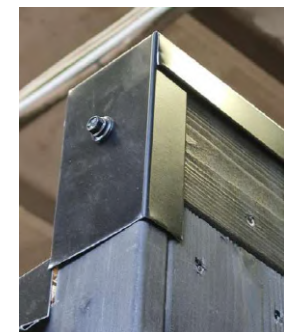
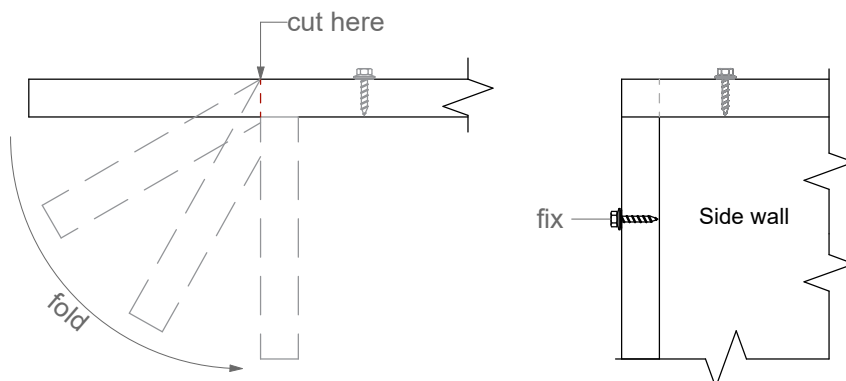

Image 6

Scheme 10.7

Congratulations on a job well done!

You have successfully completed the installation and can soon start enjoying your new sauna.

Before the first use, please read the maintenance and warranty guide and perform the necessary actions.

Maintenance

The interior surfaces of the sauna, the window frames of the steam and anteroom, and the frames of interior doors must be treated with a special substance before initial use, to protect the wood from humidity and dirt and extend the service life of the sauna.

Before initial use of the sauna, the benches and footrests must be treated with a protective oil, to extend their service life. This procedure should be repeated once or twice a year in the future.

A few suitable products for this purpose:

- TEKNOS Satu Saunasuojaor
- Tikkurila Supi Saunasuoja May

Before initial use of the sauna and once a year after that, the door, doorframe, threshold, and window frames, as well as the floors of the anteroom should be treated with the lacquer: Teknos Helo Aqua 40.

The exterior surfaces of the sauna need to be given the first protective coating right after installation. The second coating should be applied approximately two months after purchasing the sauna, to maintain its appearance. Use Remmers Aidol HK-Lasur for this purpose. The substance is available for purchase at Saunasell OÜ or from the website:

<https://trendwood.ee/tooted/viimistlus/remmers/5>.

The seller is not liable for any damage caused to the sauna due to insufficient maintenance or no maintenance at all.

Warranty

The products have a 24-month warranty period covering material and production defects, taking effect from the delivery of the sauna to the client.

The warranty is valid, if the user has reviewed the user manuals and abides by it.

The warranty does not cover characteristics of wood, such as discoloration or cracks caused by alternating or excess humidity, etc.

The warranty does not cover normal wear and tear of the product caused by its use. Any damage caused by incorrect installation or use is not compensated.

The warranty does not cover damage caused by thunder or other weather phenomena.

The warranty does not cover damage caused by incorrect installation by the client.

The warranty expires when attempts are made to independently change or fix the product or if it is not used for its intended purpose.

The warranty is void if the product is stored in an incorrect position or in the wrong conditions.

The warranty is valid if the buyer informs the seller of the defect within a reasonable time (7 days).

EXTRA: Sauna Backrest (not included in the standard set)

Install the back rest approximately 450 mm higher from the top bench.

Use 4x40 screws to fix the back rest in place and cover the screw heads with wooden cover caps.

It is recommended to additionally use glue to fix the back rest to the wall.

