

Packing List



Dispenser*1



Mounting plate*1



ST4x25 Screw*3



User Guide*1



M4x10 Screw*2



Hollow Wall Anchors*3



Key*1

Importer: Zhejiang Aike Appliances Co.,Ltd.
 Manufacturer: Zhejiang Aike Appliances Co.,Ltd.
 Yong'an Industry Zone,Xianju,Taizhou City, 317306 Zhejiang,China
 Official website: www.zjaike.com
 E-Mail: support@zjaike.com



AK-1210-LGYYSMS-001

Automatic Soap Dispenser

AK1210

EN	User Guide	1
DE	Benutzerhandbuch	4
FR	Mode d'emploi	7
IT	Guida utente	10
ES	Guía del usuario	13
JP	取扱説明書	16

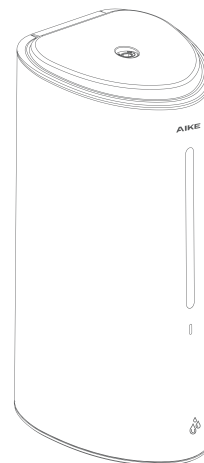

AIKE

User Guide

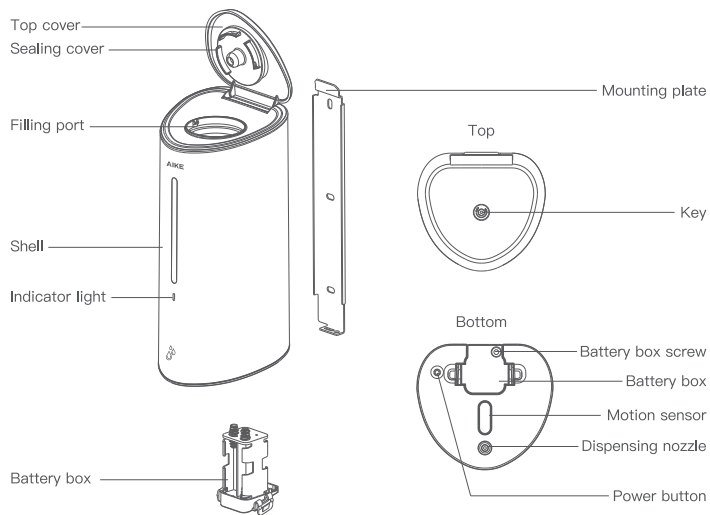

Installation height notes

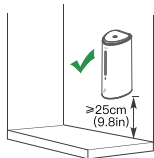

Normal Countertop

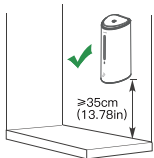

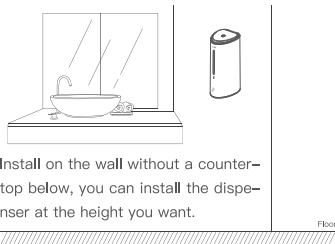

Reflective Countertop

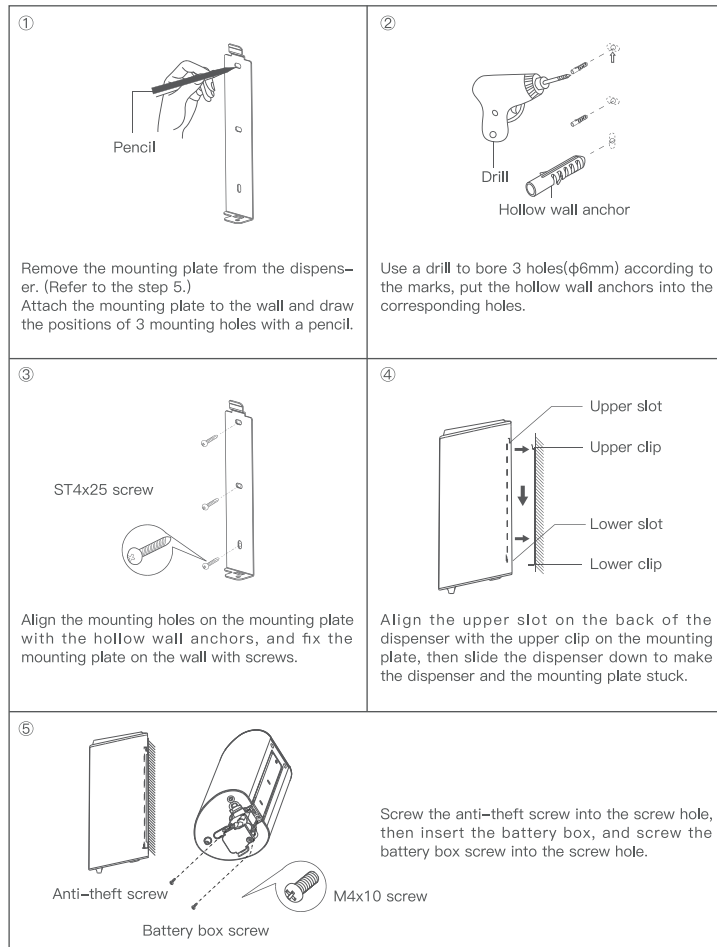

How to install your dispenser

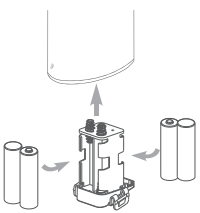
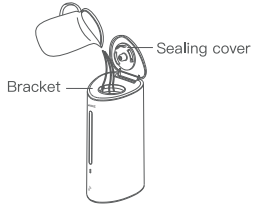
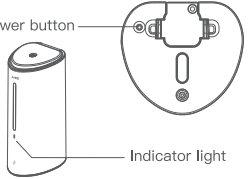

How to use your dispenser

<p>①</p>  <p>Install the batteries.</p>	<p>②</p>  <p>Sealing cover Bracket</p> <p>Open the top cover with the key, and fill in the soap. Wipe off the soap on the bracket.</p>
<p>③</p>  <p>Power button Indicator light</p> <p>Press and hold the power button to power on or off, the indicator light flashes 3 times. Press the power button after power-on to increase the dispense volume. 5 levels adjustable, the default setting is the second level, the number of times the indicator light flashes represents the current level.</p>	<p>④</p>  <p>At the first use, place your hand under the sensor for a moment, then remove it. Repeat multiple times until soap dispenses.</p>

Battery replacement reminder

The indicator light flashes three times every thirty seconds, indicating that the dispenser needs battery replacement.



1. Recommended for indoor use.
2. For daily cleaning, don't rinse the dispenser, please wipe it with a towel.
3. This dispenser is not suitable for use in the shower room.

Benutzerhandbuch

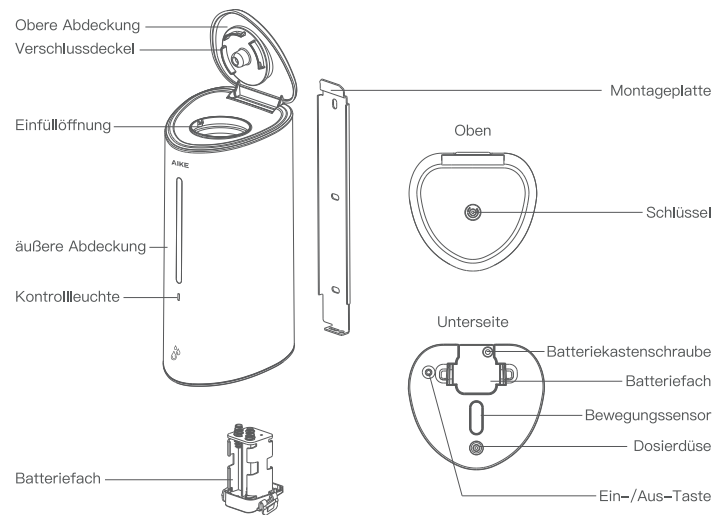

Anmerkungen zum Installationsabstand

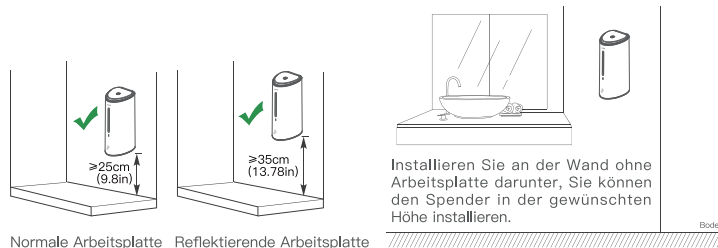

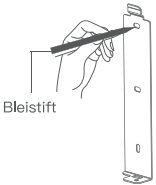
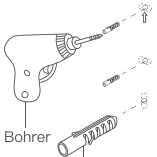
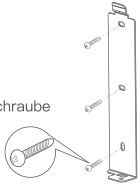
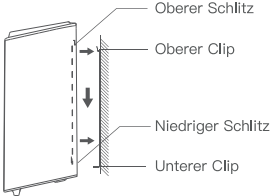
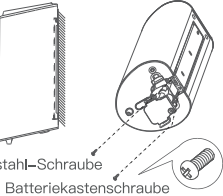

Normale Arbeitsplatte Reflektierende Arbeitsplatte

So installieren Sie Ihren Spender

<p>①</p>  <p>Bleistift</p> <p>Entfernen Sie die Montageplatte vom Spender. (Siehe Schritt 5.) Befestigen Sie die Montageplatte an der Wand und zeichnen Sie die Positionen der 3 Montagelöcher mit einem Bleistift.</p>	<p>②</p>  <p>Bohrer Ancoraggio a parete cava</p> <p>Mit einem Bohrer 3 Löcher ($\phi 6$ mm) gemäß den Markierungen bohren, die Hohlwanddübel in die entsprechenden Löcher stecken.</p>
<p>③</p>  <p>ST4x25 Schraube</p> <p>Richten Sie die Montagelöcher der Montageplatte mit den Hohlwanddübeln aus und befestigen Sie die Montageplatte mit Schrauben an der Wand.</p>	<p>④</p>  <p>Oberer Schlitz Oberer Clip Niedriger Schlitz Unterer Clip</p> <p>Richten Sie den oberen Schlitz auf der Rückseite des Spenders mit dem oberen Clip an der Montageplatte aus und schieben Sie den Spender dann nach unten, um den Spender und die Montageplatte zu verkleben.</p>
<p>⑤</p>  <p>Anti-Diebstahl-Schraube Batteriekastenschraube M4x10 Schraube</p> <p>Schrauben Sie die Anti-Diebstahl-Schraube in das Schraubenloch, setzen Sie dann das Batteriefach ein und schrauben Sie die Schraube des Batteriefachs in das Schraubenloch.</p>	

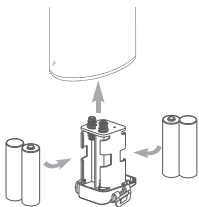
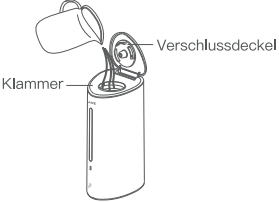
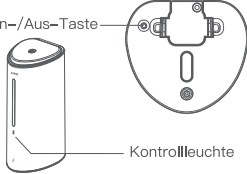
So verwenden Sie Ihren Spender

<p>①</p>  <p>Legen Sie die Batterien ein.</p>	<p>②</p>  <p>Verschlussdeckel Klammer</p> <p>Öffnen Sie die obere Abdeckung mit dem Schlüssel und füllen Sie die Seife ein. Wischen Sie die Seife an der Halterung ab.</p>
<p>③</p>  <p>Ein-/Aus-Taste Kontrollleuchte</p> <p>Halten Sie die Einschalttaste gedrückt, um das Gerät ein- oder auszuschalten, die Kontrollleuchte blinkt 3 Mal. Drücken Sie nach dem Einschalten die Einschalttaste, um das Ausgabevolumen zu erhöhen. 5 Stufen einstellbar, die Standardeinstellung ist die zweite Stufe, die Anzahl der Blinksignale der Kontrollleuchte stellt die aktuelle Stufe dar.</p>	<p>④</p>  <p>Legen Sie bei der ersten Verwendung Ihre Hand für einen Moment unter den Sensor und entfernen Sie ihn dann. Wiederholen Sie dies mehrmals, bis die Seife austritt.</p>

Erinnerung an Batteriewechsel

Die Kontrollleuchte blinkt dreimal alle 30 Sekunden und zeigt damit an, dass die Batterie des Spenders ausgetauscht werden muss.



1. Empfohlen für den Innenbereich.
2. Für die tägliche Reinigung spülen Sie den Spender nicht aus, sondern wischen Sie ihn mit einem Handtuch ab.
3. Dieser Spender ist nicht für die Verwendung im Duschaum geeignet.

Guide de l'utilisateur

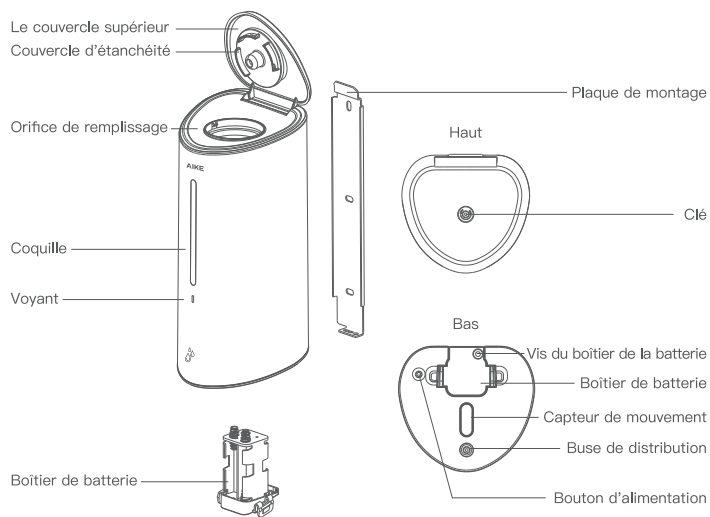

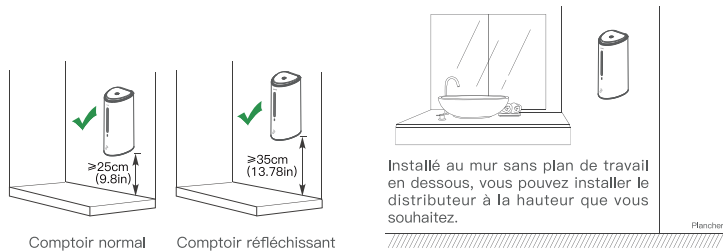

Notes sur la distance d'installation

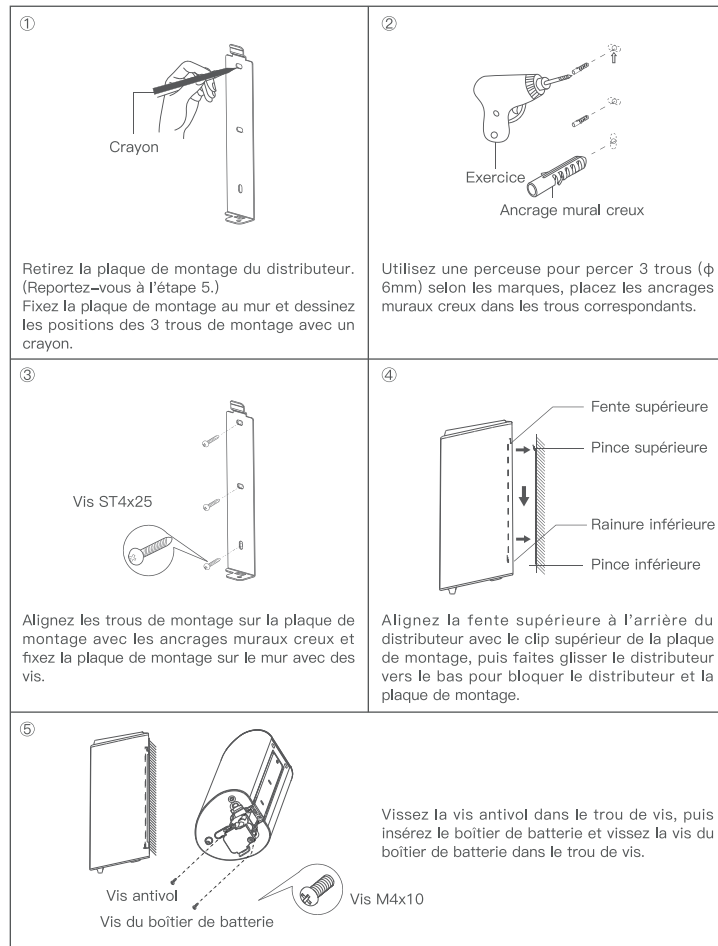

Comment installer votre distributeur

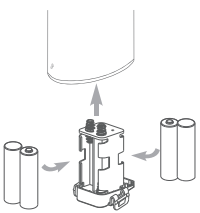
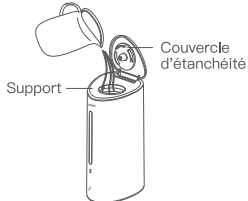
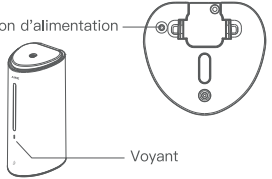

Comment utiliser votre distributeur

<p>①</p>  <p>Installer les piles.</p>	<p>②</p>  <p>Ouvrez le couvercle supérieur avec la clé et remplissez le savon. Essayez le savon sur le support.</p>
<p>③</p>  <p>Appuyez et maintenez le bouton d'alimentation pour allumer ou éteindre, le voyant clignote 3 fois. Appuyez sur le bouton d'alimentation après la mise sous tension pour augmenter le volume de distribution. 5 niveaux réglables, le réglage par défaut est le deuxième niveau, le nombre de fois le voyant clignote représente le niveau actuel.</p>	<p>④</p>  <p>Lors de la première utilisation, placez votre main sous le capteur pendant un instant, puis retirez-le. Répétez plusieurs fois jusqu'à ce que le savon se distribue.</p>

Rappel de remplacement de la batterie

Le voyant lumineux clignote trois fois toutes les trente secondes, indiquant que le distributeur a besoin d'être remplacé.



1. Recommandé pour une utilisation en intérieur.
2. Pour le nettoyage quotidien, ne rincez pas le distributeur, veuillez l'essuyer avec une serviette.
3. Ce distributeur ne convient pas pour une utilisation dans la salle de douche.

Guida utente

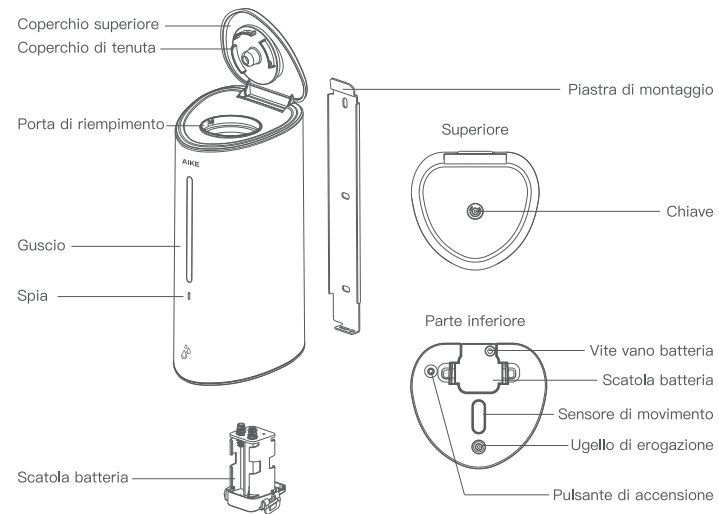



Note sulla distanza di installazione

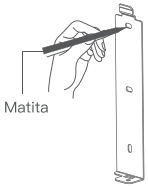
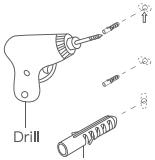
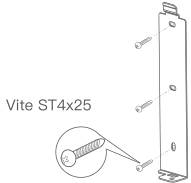
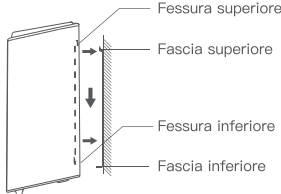
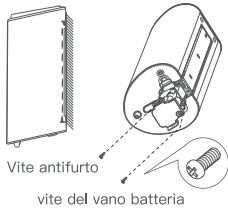

Come installare il distributore

<p>①</p>  <p>Matita</p> <p>Rimuovere la piastra di montaggio dall'erogatore. (Fare riferimento al passaggio 5.) Fissare la piastra di montaggio alla parete e disegnare le posizioni dei 3 fori di montaggio con una matita.</p>	<p>②</p>  <p>Drill</p> <p>Ancoraggio a parete cava</p> <p>Utilizzare un trapano per praticare 3 fori ($\phi 6$ mm) secondo i segni, inserire i tasselli cavi nei fori corrispondenti.</p>
<p>③</p>  <p>Vite ST4x25</p> <p>Allineare i fori di montaggio sulla piastra di montaggio con gli ancoraggi a parete cava e fissare la piastra di montaggio alla parete con le viti.</p>	<p>④</p>  <p>Fessura superiore</p> <p>Fascia superiore</p> <p>Fessura inferiore</p> <p>Fascia inferiore</p> <p>Allineare la fessura superiore sul retro del distributore con la clip superiore sulla piastra di montaggio, quindi far scorrere il distributore verso il basso per bloccare il distributore e la piastra di montaggio.</p>
<p>⑤</p>  <p>Vite antifurto</p> <p>Vite M4x10</p> <p>vite del vano batteria</p> <p>Avvitare la vite antifurto nel foro della vite, quindi inserire la scatola della batteria e avvitare la vite della scatola della batteria nel foro della vite.</p>	

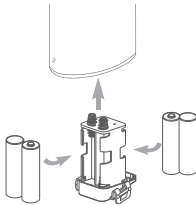
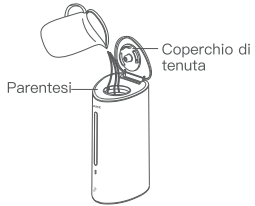
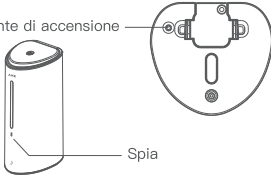
Come usare il tuo dispenser

<p>①</p>  <p>Installare le batterie.</p>	<p>②</p>  <p>Coperchio tenuto</p> <p>Parentesi</p> <p>Apri il coperchio superiore con la chiave e riempi il sapone. Pulisci il sapone sulla staffa.</p>
<p>③</p>  <p>Pulsante di accensione</p> <p>Spia</p> <p>Tenere premuto il pulsante di accensione per accendere o spegnere, la spia lampeggia 3 volte. Premi il pulsante di accensione dopo l'accensione per aumentare il volume di erogazione. 5 livelli regolabili, l'impostazione predefinita è il secondo livello, il numero di volte in cui la spia lampeggia rappresenta il livello attuale.</p>	<p>④</p>  <p>Al primo utilizzo, mettere per un momento la mano sotto il sensore, quindi rimuoverlo. Ripetere più volte fino all'erogazione del sapone.</p>

Promemoria di sostituzione della batteria

La spia lampeggia tre volte ogni trenta secondi, indicando che l'erogatore deve sostituire la batteria.



1. Consigliato per uso interno.
2. Per la pulizia quotidiana, non risciacquare il dispenser, pulirlo con un asciugamano.
3. Questo dispenser predefinito è adatto per l'uso nella doccia.

Guía del usuario

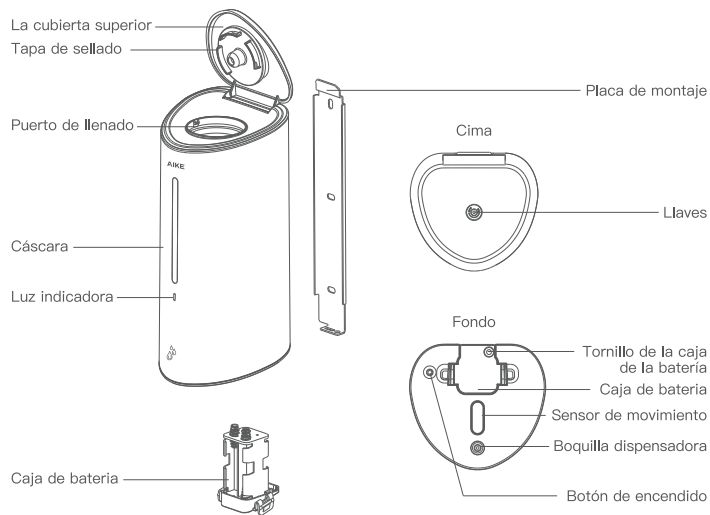

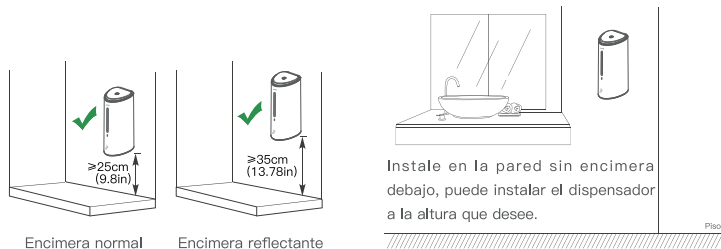

Distancia de instalación

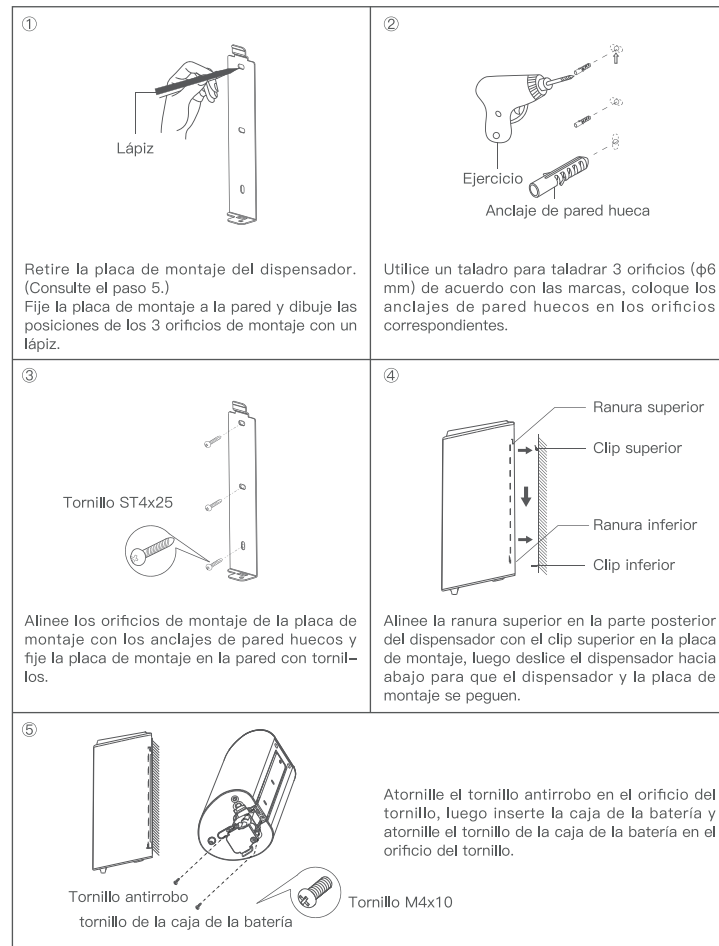

Cómo usar su dispensador

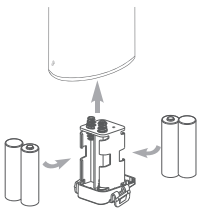
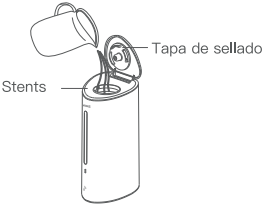
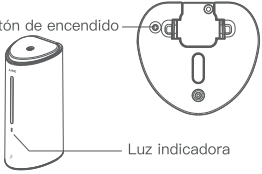

Cómo usar su dispensador

<p>①</p>  <p>Instale las baterías.</p>	<p>②</p>  <p>Tapa de sellado</p> <p>Stents</p> <p>Abra la tapa superior con la llave y llene el jabón. Limpie el jabón en el soporte.</p>
<p>③</p>  <p>Botón de encendido</p> <p>Luz indicadora</p> <p>Mantenga presionado el botón de encendido para encender o apagar, la luz indicadora parpadea 3 veces.</p> <p>Presione el botón de encendido después del encendido para aumentar el volumen de dispensación. 5 niveles ajustables, la configuración predeterminada es el segundo nivel, el número de veces que la luz indicadora parpadea representa el nivel actual.</p>	<p>④</p>  <p>En el primer uso, coloque su mano debajo del sensor por un momento, luego retirelo. Repita varias veces hasta que se dispense el jabón.</p>

Recordatorio de cambio de batería

La luz indicadora parpadea tres veces cada treinta segundos, lo que indica que el dispensador necesita reemplazo de batería.



1. Recomendado para uso en interiores.
2. Para la limpieza diaria, no enjuague el dispensador, límpielo con una toalla.
3. Este dispensador no es adecuado para su uso en el cuarto de baño.

ユーザーガイド

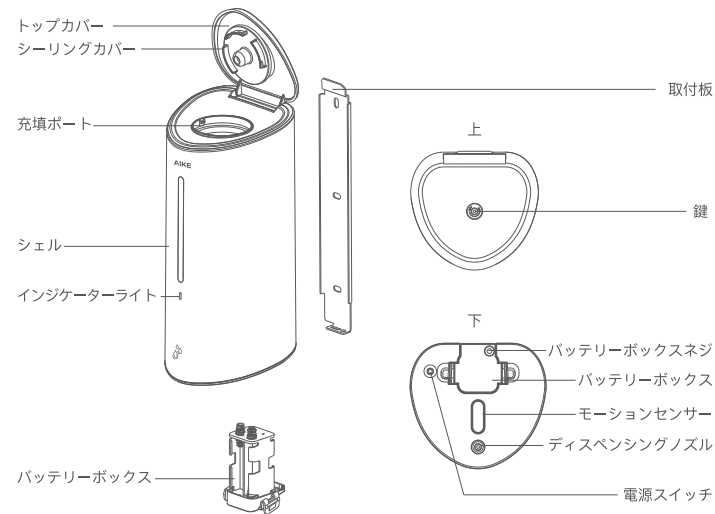

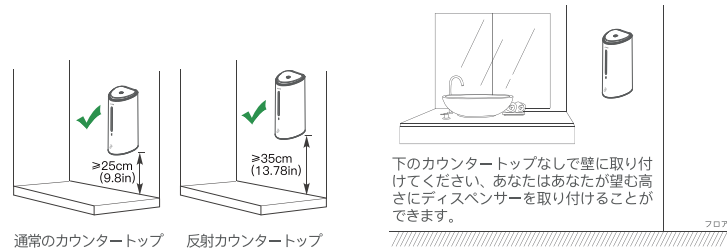

インストール距離メモ

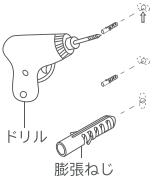
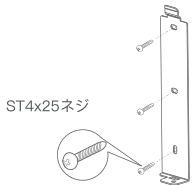
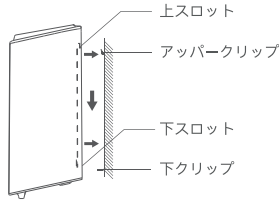
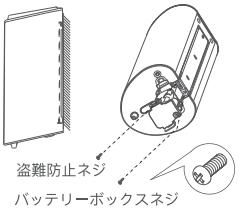

あなたのディスペンサーを設置する方法

<p>①</p>  <p>鉛筆</p> <p>ディスペンサーから取り付けプレートを取り外します。(手順5を参照してください。)</p> <p>取り付けプレートを壁に取り付け、鉛筆で3つの取り付け穴の位置を描きます。</p>	<p>②</p>  <p>ドリル</p> <p>膨張ねじ</p> <p>ドリルを使用して、マークに従って3つの穴(φ6mm)を開け、対応する穴に中空壁アンカーを配置します。</p>
<p>③</p>  <p>ST4x25ネジ</p> <p>取り付けプレートの取り付け穴を中空の壁アンカーに合わせて、取り付けプレートを壁にネジで固定します。</p>	<p>④</p>  <p>上スロット</p> <p>アッパークリップ</p> <p>下スロット</p> <p>下クリップ</p> <p>ディスペンサーの背面にある上部スロットを取り付けプレートの上部クリップに合わせてから、ディスペンサーを下にスライドさせて、ディスペンサーと取り付けプレートを固定します。</p>
<p>⑤</p>  <p>盗難防止ネジ</p> <p>バッテリーボックスネジ</p> <p>M4x10ネジ</p> <p>盗難防止用ネジをネジ穴にねじ込み、次にバッテリーボックスを挿入し、バッテリーボックスネジをネジ穴にねじ込みます。</p>	

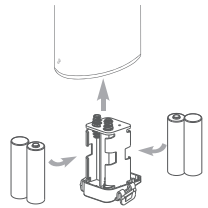
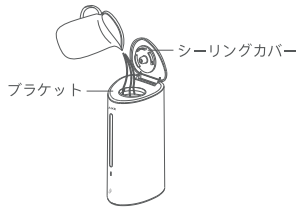
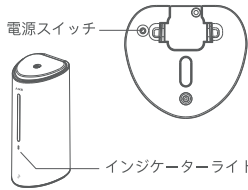
ディスペンサーの使用方法

<p>①</p>  <p>電池を取り付ける。</p>	<p>②</p>  <p>シーリングカバー</p> <p>トレイ</p> <p>キーでトップカバーを開け、石鹸を入れます。トレイの石鹸を拭き取ります。</p>
<p>③</p>  <p>電源スイッチ</p> <p>インジケータライト</p> <p>電源ボタンを押し続けると、電源がオンまたはオフになり、インジケータライトが3回点滅します。電源を入れた後、電源ボタンを押して、分注量を増やします。5レベル調整可能、デフォルト設定は2番目のレベルで、インジケータライトが点滅する回数は現在のレベルを表します。</p>	<p>④</p>  <p>初めて使用するときは、センサーの下に手を置いてから取り外します。石鹸がなくなるまで何度も繰り返します。</p>

バッテリー交換リマインダー

インジケータライトは30秒ごとに3回点滅し、ディスペンサーのバッテリー交換が必要であることを示します。



1. 屋内での使用をお勧めします。
2. 毎日のお手入れは、ディスペンサーを洗い流さないでください。タオルで拭いてください。
3. このディスペンサーは、シャワールームでの使用には適していません。