



# Power Pet

Fully Automatic Pet Door



INSTALLATION &  
OPERATING INSTRUCTIONS

U.S. PATENT # 5,872,516



## INTRODUCTION

### Product Description:

Your new POWER PET Electronic Pet Door is like no other pet door made. Patented POWER PET™ electronic pet doors are fully automatic, motor driven and open completely under their own power. Activated by an ultrasonic pet collar, your new POWER PET door will keep out stray animals. It is secure against wind, rain, cold and snow and provides much better insulation than a conventional flap door. Your new POWER PET door features an attractive, high-strength door panel that quickly and quietly powers upward disappearing into the stylish housing. Your pets are empowered to come and go as they please while their animal friends are politely asked to stay out.

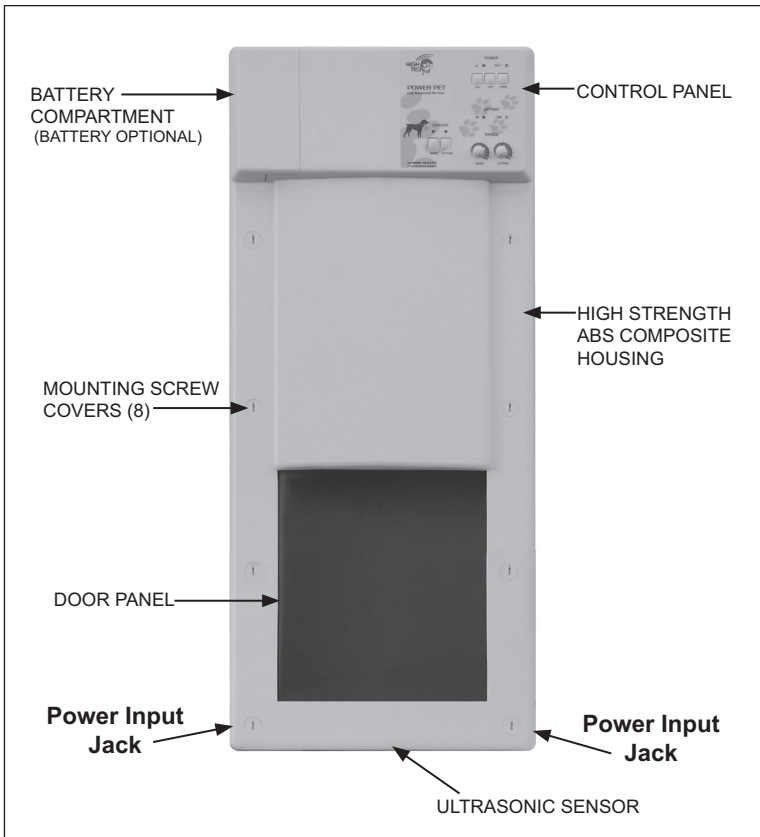

*POWER PET doors increase home security with a special automatic, dead-bolt locking feature that guards against would-be intruders. Only the coded signal from your pet's collar will open the Power Pet door.*

*Only Power Pet doors feature an ingenious directional sensing system that operates a fully automatic, motor driven panel. The signal emitted from your pet's collar tells the Power Pet door how far away your pet is and the direction in which your pet is traveling. This allows the Power Pet to work like magic, opening only when your pet is on a direct approach, not when it is just wandering by and not when it is sitting or sleeping next to the door.*

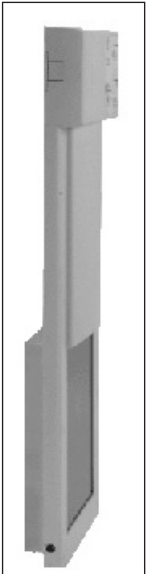

### **ALL NEW DESIGN!**

*After selling thousands of our original POWER PET, PP models we are very pleased to introduce our All New, completely redesigned and restyled PX Model. We listened to the feedback of hundreds of customers and threw in a few ingenious, new ideas of our own to bring you the ultimate combination of security, style and convenient features.*

*The PX model, which features an extremely slim design, is less than 2 inches deep. This allows it to be mounted flush to your door or wall. You cut a hole only as large as the door panel itself, then mount your POWER PET door in front of the opening. You will find it is actually easier to install a POWER PET door than a conventional pet door and certainly easier than installing a "between the studs type door"*

*The PX is constructed of an ultra-high strength ABS composite housing with a bullet-proof Lexan plastic door panel, giving you and your pet the ultimate in security. The Lexan panel is mounted on a sliding, air-tight seal for the best wind, rain and foul weather protection of any pet door made.*

*This new, absolutely state of the art design represents unquestionably the most advanced, most reliable, most stylish pet door made anywhere. In fact, your new POWER PET **Fully Automatic** Pet Door will be the most sophisticated appliance your pet will ever own!*

## **Your POWER PET door package includes:**

- **One Pet Transmitter Collar** (Model MS-4 or MS-5 Ultrasonic Transmitter Collar)
- **110 volt AC Adapter** (connects to either Power Input Jack on edge of inside frame)
- **Pre-Fabricated Outside Frame**
- **All Required Hardware**

(Wall Adapter Tunnel, Rechargeable Battery, Battery Charger Kit and Extra Transmitter Collars are sold separately.)

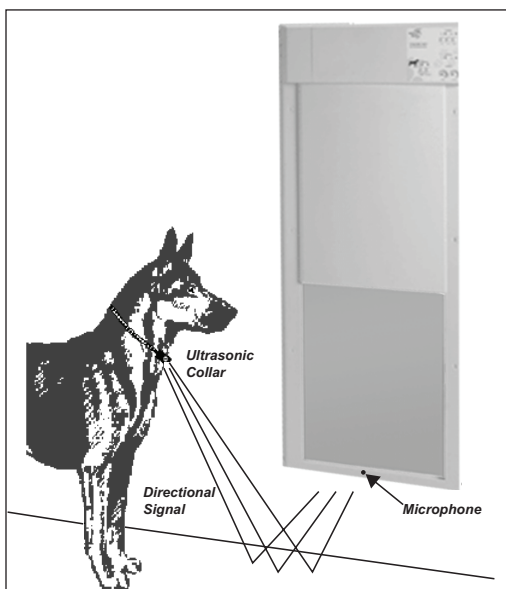

## **PET COLLAR OPERATED**

Only the amazing POWER PET door uses our Patented directional ultrasonic sensing system. This system has great advantages over magnetic or radio transmitter collars.

Magnetic collars have a very limited range making it tough to train the pet to operate the door. Radio systems have good range but open whenever the animal is within that range, even if the pet is sitting, sleeping or just wandering by.

The Power Pet's directional ultrasonic system overcomes these problems. The Pet worn ultrasonic collar emits a highly directional signal, which is received by the microphone only when your pet is directly facing the door opening. The unit is not likely to trigger if your pet is just wandering by.

Typically the ultrasonic signal is bounced off the ground in the direction which your pet is facing. This means that surfaces which are highly reflective such as tile and linoleum will result in a longer working range than acoustically absorbent surfaces such as carpeting. Consult the **ADJUSTING RANGE CONTROLS** section for instructions on setting the desired opening range.

## INSTALLATION

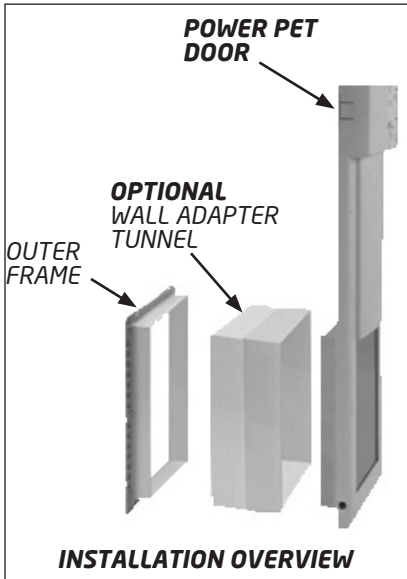

## MOUNTING YOUR POWER PET DOOR

Your POWER PET door mounts flush to any door or wall. The hardest part of installing the POWER PET door is cutting the hole. If the unit is to be mounted in a door up to 1 ¾" thick there is no framing necessary. The pre-made Outer Frame that came with your POWER PET door will provide a finished look to the opening. If you are installing your POWER PET door in a wall, it is advisable to build a frame around the opening or order our convenient WALL ADAPTER TUNNEL. The hole dimensions given are for the finished opening

not including the frame. Dimensions of the frame you build should be added to the opening size to determine the final size of the hole you cut in your wall.

## WALL INSTALLATION

## DOOR INSTALLATION

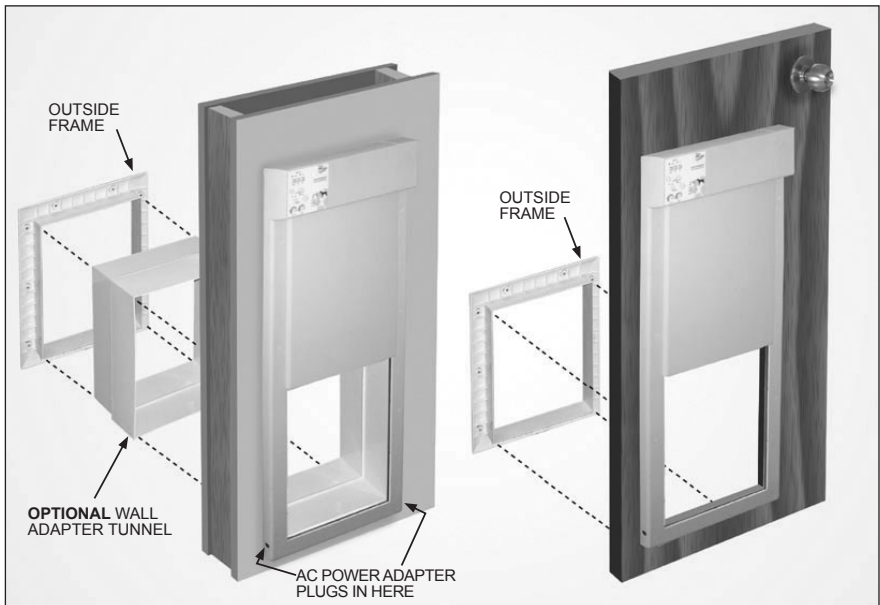

## POSITIONING THE OPENING ON THE DOOR OR WALL

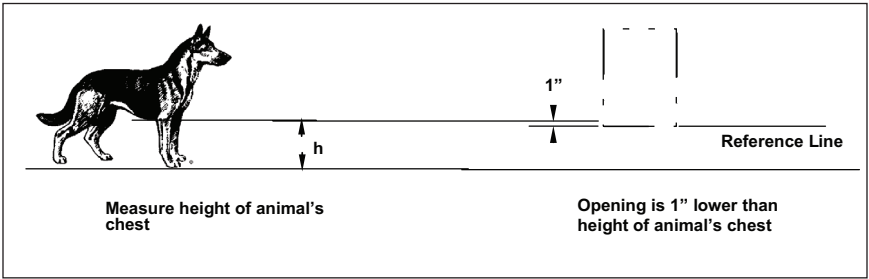

## CUT-OUT DIMENSIONS:

### Model PX-1

### Model PX-2

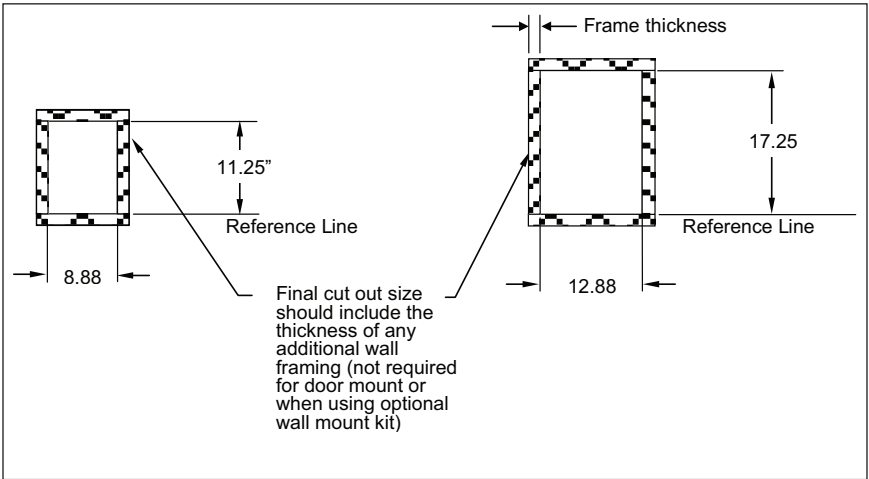

# INSTALLING YOUR POWER PET DOOR

This is the easy part. Install the POWER PET and Outside Frame as shown below.

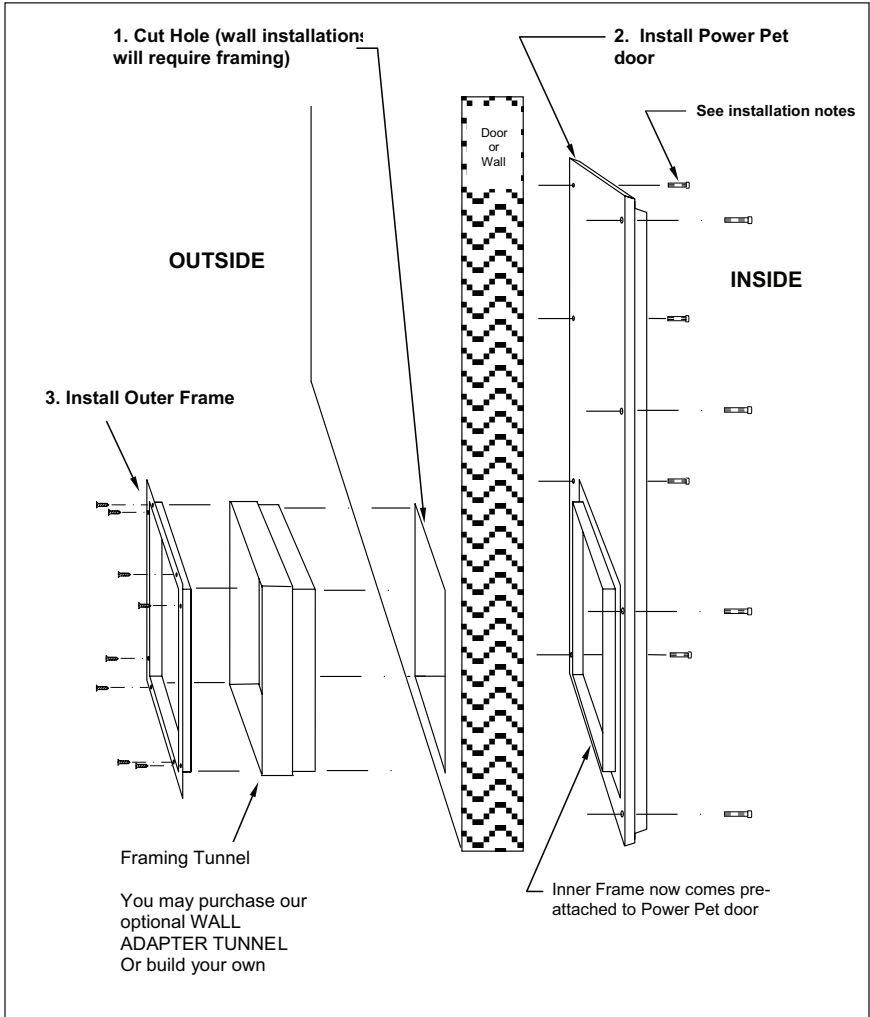

## IMPORTANT INSTALLATION NOTES:

**a) When installing the inside mounting screws, make sure they are only moderately tight. Over tightening will cause your Power Pet door housing to conform to any irregularities in the flatness of your door or wall and will cause the door panel to slow, stick or malfunction. Just tighten the screws until they stop. That**



is enough to insure that the installation is secure. Should your door panel malfunction during the initial power up, loosen each mounting screw and re-test.

**b)** Note that screw covers (not pictured) are provided to finish the screw holes. Once installed, the inside screw covers may be removed by twisting **CLOCKWISE** using a coin or flat head screwdriver. Twisting counter-clockwise will cause the screw covers to break.

### Initial Power up

Plug the AC Adaptor into a nearby 110 VAC wall outlet. Plug adaptor cord into the left or right Power Input Jack on the inside frame. (see page 3)

Press the front panel ON button to power up the door. Verify the AC light is illuminated.

Press the manual OPEN button and verify the door panel opens and closes by itself.

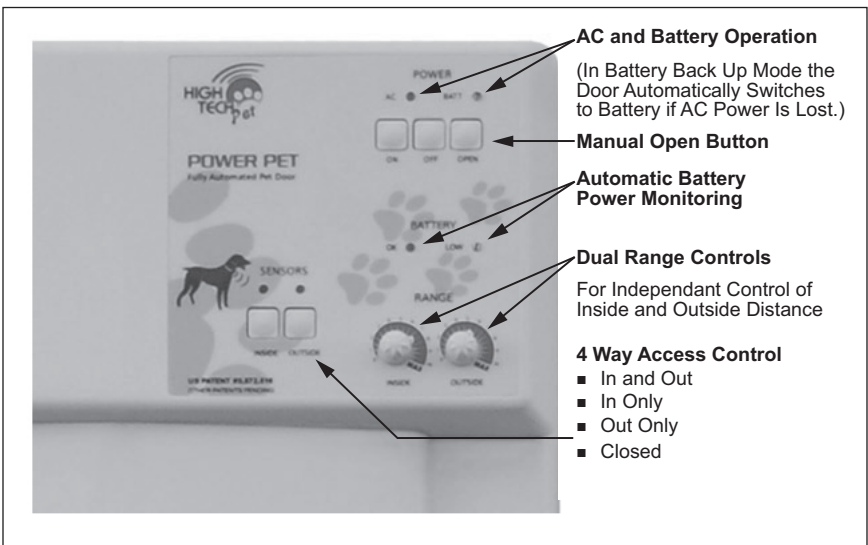

## **Battery Installation**

To install the battery, open the battery compartment, and align the two battery lugs with the two lug sockets on the inner wall of the battery compartment. Then press the battery to mate it to the sockets. When done the battery should be flush with the wall, and the compartment cover should fit comfortably over the installed battery.

An installed battery is automatically charged whenever the AC Adaptor is powering the door.

## **Battery Status Indicators**

The OK light is illuminated when the battery is more than one-third charged.

The LOW light illuminates when the battery is less than one-third charged.

**Note that during door opening these indicators may reverse for a few seconds when the battery is below one-half charge. This is normal and gives a little advance notice of an impending low battery.**

## **Battery Operation**

Whenever AC Power is unavailable and a charged battery is installed, the front panel indicators go into a low power mode where they blink every four seconds instead of remaining on continuously. This feature allows the battery to power the door for up to two months or 500 openings.

## **ADVANCED FEATURES**

### **INTRINSICALLY SAFE OPERATION**

The POWER PET electronic pet door is intrinsically safe. It uses an electric motor and cable drive to lift the door panel. The panel remains open until the pet collar signal is gone, indicating that your pet is clear of the opening. When the pet collar signal is gone, power to the motor is turned off and the panel is returned by the force of gravity only. Downward speed is reduced by an electronic brake applied to the reverse motion of the motor. This brake operates with or without electrical power. Because the panel is returned by simple gravity, the maximum force that can be applied by the panel when it is closing is limited to its own weight. The door panel weighs only about 2 lbs.

### **AUTO RETRACT FEATURE**

As an added safety feature, the POWER PET also has a sensing system that automatically raises the panel should it encounter an obstruction

on the way down. This feature can be defeated in the unusual case that binding or other restriction slows the door closure to the point that it unnecessarily retracts. See the **AUTOMATIC SAFETY RETRACT** Section for more information.

## **AUTO DEAD BOLT LOCKING FEATURE**

The POWER PET door uses a spring loaded locking pin which automatically snaps into its retaining hole when the movable panel comes to rest in the closed position. The pin can only be released when the motor applies tension to the cable. This makes it impossible for even the most clever animals (and people) to raise the panel mechanically.

**THREE DIFFERENT POWER CHOICES:** Your new POWER PET™ Door may be operated in three different power modes.

1. **110 volt AC Wall Outlet:** Your standard POWER PET™ Door comes standard with a U.L. approved AC adapter. Plug the adapter into a nearby wall outlet for continuous operation.
2. **AC with Battery Back-up:** You may purchase an optional rechargeable battery for use along with your AC adapter. If your household electricity should ever fail, your POWER PET™ Door will automatically switch over to battery operation. When power is restored, the AC adapter will automatically recharge your battery.
3. **Full Battery Operation:** You may also operate your POWER PET™ Door with the battery only. This eliminates the need for the AC adapter or any electrical power connection. However, you will need to recharge the battery periodically. (Recharge interval varies depending upon use.) In this case, we recommend that you purchase the optional battery and a battery charger kit. With the charger kit you get a battery charger and an extra battery. Use one battery in your POWER PET™ Door and keep the other in the charger. When your door battery runs low, just swap.

**DUAL RANGE CONTROLS:** Individual range control to allow you to adjust different activation distances for inside and outside of your home. (Usually, it's a good idea to use a short distance of a foot or two inside, and a longer 4 to 5 foot distance outside.) Your new POWER PET PX gives you full control. Note: range markings on the door are not in units of distance, but rather in signal strength. A marking of 10 produces the maximum distance.

## **Adjusting the Range**

**When you first install the POWER PET PX door, pre-set both RANGE Controls - one at a time - to the desired activation distance as follows:**

- Enable just the *INSIDE* or *OUTSIDE* sensor and set that RANGE control to zero.
- Hold the collar at about your pet's height, pointing down toward the bottom of the door and at the desired activation distance from the door.
- Slowly increase that RANGE Control setting until the panel opens.
- Repeat this for the other sensor.
- Now put the collar on the pet and, if necessary, readjust the RANGE settings slightly to achieve the desired opening distance.

Just as your hearing of a conversation can be overpowered by loud noises such as a lawn mower, the door sensors can also be overpowered by loud ultrasonic noises. Specifically some sprinklers, lawn mowers and vacuum cleaners can put out enough noise to temporarily mask the collar signal. The POWER PET PX door has a unique feature which indicates when the background noise level is too high. Whenever the *INSIDE* noise is too loud, the *INSIDE* light will flicker or flash on. This means you may want to decrease the *INSIDE* knob setting slightly. Likewise, whenever the *OUTSIDE* noise is too high, the *OUTSIDE* light will flicker or flash on. This means you may want to decrease slightly the *OUTSIDE* knob setting. A little flickering once in a while is normal. A lot of flickering or continuous flashing means the knob is set too high.

**4 WAY ACCESS CONTROL:** Individual activation buttons for the inside and outside sensors give you a 4-way access control system. You can allow your pet to come in but not go out, go out but not come in, come in and out or close and lock the door altogether

**AUTOMATIC CLOSE CONTROL:** Your POWER PET PX Features a smart sensing circuit that keeps the door panel open as long as it is receiving the signal from your pet's collar. Once your pet has moved completely through the opening, the panel closes.

**ADJUSTABLE HOLD UP TIME:** The door is held open for a short time to let the pet get fully through the door before it starts closing. Depending on the speed your pet moves, you may adjust the hold up time as follows.

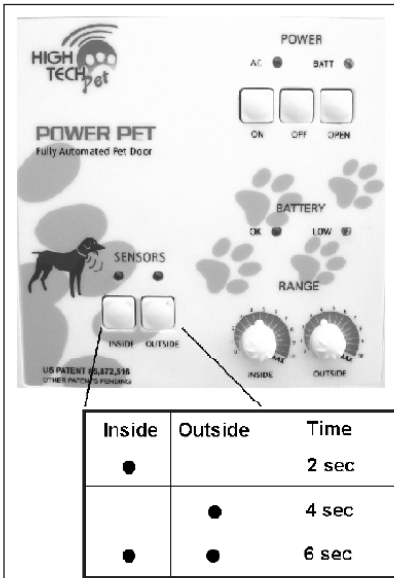

1. Press OFF button
2. Press and hold one or both sensor buttons to select hold up time
3. Press OFF button to save this hold up time
4. Press ON button to power the door.

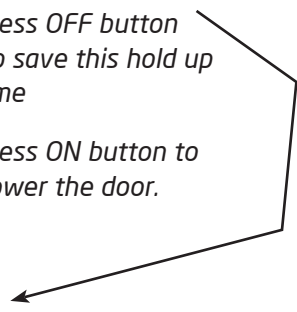

When shipped from the factory the hold up time is set to 4 seconds. We recommend you initially introduce your pet to the door with a long hold up time. Later you can reduce the hold up time if desired.

**HOLD OPEN FEATURE:** A new feature introduced in 2012 allows the door to be manually opened and stay open for any length of time.

If you wish to leave the door open for an extended time period, use the **Hold Open Mode**, as follows. The door panel will remain open as long as power is available.

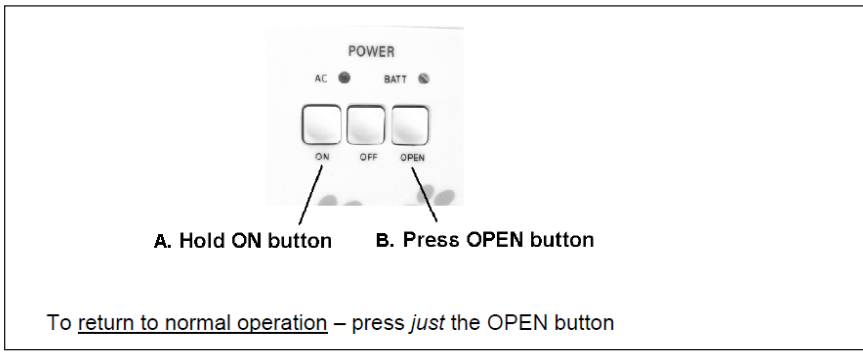

The opening motor is energized the entire time the door is open. So if using only a battery to power the door, and you do not have an AC Power Adaptor plugged into the door, use this feature sparingly to keep from discharging the battery in just a few hours.

**AUTOMATIC SAFETY RETRACT:** Your POWER PET PX is intrinsically safe for all pets and people, including small children. The door panel weighs less than 2 lbs. and is closed smoothly by gravity (not the motor) and is too light to cause any physical injury. However, just to be doubly safe around infants, we've included an automatic safety retract feature. This feature causes the panel to instantly retract if it encounters an obstruction during closure.

**DEFEATING THE AUTOMATIC SAFETY RETRACT:** Under unusual conditions, such as a warped wall mounting, the door sometimes may close so slowly that the auto-retract feature triggers the door to re-open unnecessarily. In these cases it may be desirable to defeat the Automatic Safety Retract feature. Do this by first pressing the OFF button to turn off the door controls and all the lights. Leave the door powered by the wall wart or battery when you do this. Then while holding down the MANUAL OPEN button, press and release the OUTSIDE SENSOR button. The OUTSIDE light will blink to indicate the feature has been disabled.

**ENABLING AUTOMATIC SAFETY RETRACT:** Similarly you may enable the Automatic Safety Retract feature at any time. Do this by first pressing the OFF button to turn off the door controls and all the lights. Leave the door powered by the wall wart or battery when you do this. Then while holding down the MANUAL OPEN button, press and release the **INSIDE SENSOR** button. The **INSIDE** light will blink to indicate the feature has been enabled. When shipped from the factory, the automatic safety retract feature is enabled.

After Defeating or Enabling the feature, press the **POWER ON** button to resume normal door operation.

## **PET COLLAR OPERATING INSTRUCTIONS**

Your POWER PET DOOR comes with a standard model MS-4 or MS-5 ultrasonic transmitter collar. Each collar includes a battery TEST button which illuminates a red LED when the battery is OK. If the LED fails to light, battery replacement is necessary.

**Note:** To energize the MS-4 Collar, pull out and discard the PULL TAB which is protruding from the side of the collar.

To energize the MS-5 Collar, open the case, as shown in the **Battery Replacement** section below, and pull out the PULL TAB. Discard the PULL TAB and close up the case.

### **ADJUSTING THE STRAP**

1. Fasten the collar around your pet's neck so that it fits comfortably. In most cases there will be excess strap length.
2. With a soft pencil or magic marker, mark the amount of strap to be removed leaving at least one inch past the D-ring buckle.
3. Remove the collar from your pet and cut off the excess strap at the mark.
4. To avoid fraying carefully heat the cut end with an open flame to melt and fuse the material.
5. Re-fasten the collar around your pet's neck so that it hangs loosely and comfortably.

Your High Tech Pet MS-4 or MS-5 transmitter collar will operate for 3 to 5 months on a single, easily replaceable battery.

Replacement batteries, part number B3V1A, are available from **[www.hightechpet.com](http://www.hightechpet.com)**.

## REPLACING THE MS-4 BATTERY

1. Insert screwdriver or knife in end slot and pry open.



2. Separate top from bottom.

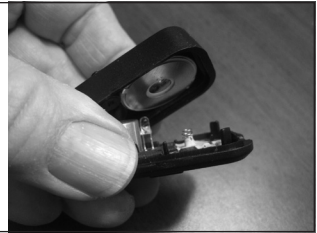

3. Replace battery top with the metal ring visible.



4. Carefully mate top and bottom while keeping aluminum speaker centered in the top hole. Squeeze together the top and bottom until both ends snap.

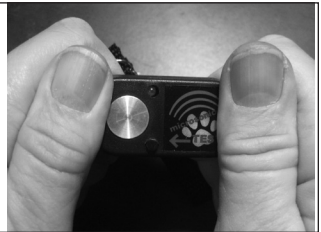



## REPLACING THE MS-5 BATTERY

1. *Unscrew the bottom cover.*

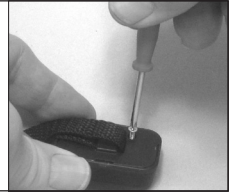

2. *Pry bottom from top on ends and on edges using small flat blade screwdriver*

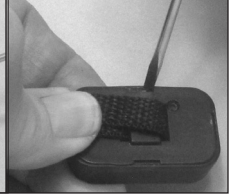
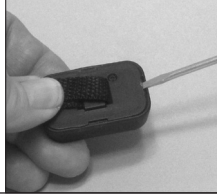

3. *Remove bottom, note battery orientation*



4. *Remove and replace B3V1A battery*

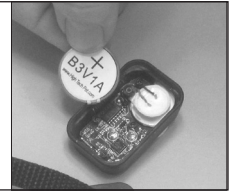

5. *With new battery installed, close case. Squeeze until bottom flush with top, by squeezing top and bottom together*

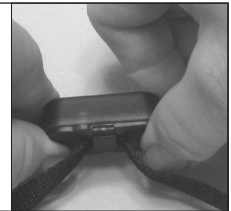

6. *Insert and tighten screw.*



## **REPLACING THE MS-5 BATTERY**

### **WATER RESISTANCE**

*The High Tech MS-4 ultrasonic transmitter collar is water resistant meaning that rainy weather and humidity will not damage the unit. These collars are NOT designed to be fully immersed in water. Should this occur, simply open the unit, shake out water and let dry. In most cases the unit will function normally. However the life of the battery will likely be reduced or the battery may require replacement.*

*The MS-5 collar is fully waterproof to a 3 foot depth.*

### **TRAINING YOUR PET**

*Training your pet to use its new POWER PET door should be a relatively effortless task. Some pets may become startled by the sound and movement of the panel, but be patient. Nearly every pet will soon be used to the POWER PET'S operation and learn to love using its own personal entry. We recommend that you lead your pet to the door and allow it to open several times to teach the animal the cause and effect relationship between pet and door. Then place a food reward on the opposite side and lead the animal through the opening, allowing it to get the reward on the other side. Repeat several times. Before too long your pet will get the idea. If your pet doesn't get it in one sitting, remain patient and let your pet just walk around on its own for awhile. It won't take too much more time for your pet to realize the POWER PET opens whenever the pet comes its way. One of the most frequent comments we hear from POWER PET owners is how much their pets love using their POWER PET door. We are sure your pet will feel the same!*

### **REPLACEMENT PARTS**

*Over the years you may need to replace damaged or worn out parts. High Tech Pet Products offers complete refurbishment of the door at our facility in Ventura CA. Contact Customer Service for instructions on shipping your door back to us. For customers with the mechanical skills to refurbish themselves, we offer many replacement parts on our web site, [www.hightechpet.com](http://www.hightechpet.com) along with do-it-yourself instructions.*

## MANY CONVENIENT ACCESSORIES!

We've added all sorts of great new options to make your POWER PET PX the most versatile pet door you'll find.

### EXTRA PET COLLARS:

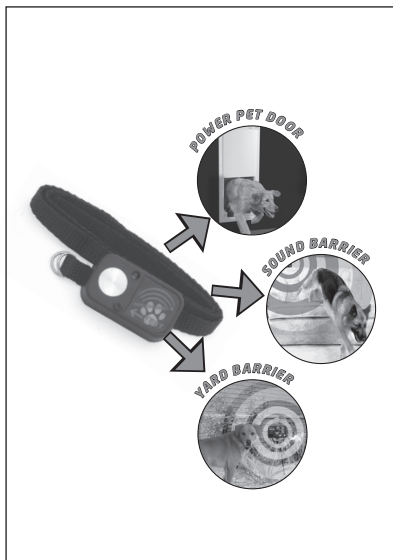

#### Model MS-4 or MS-5 Ultrasonic Transmitter Collar

You may wish to purchase an Extra collar for each additional pet and keep one or two more as spares. Lightweight and comfortable on all cats and dogs.

These collars will operate all our ULTRASONIC devices including:

- POWER PET Fully Automatic Pet Doors
- SOUND BARRIER Non-Shock, Indoor Sonic Fence
- YARD BARRIER Non-Shock, Outdoor Sonic Fence.

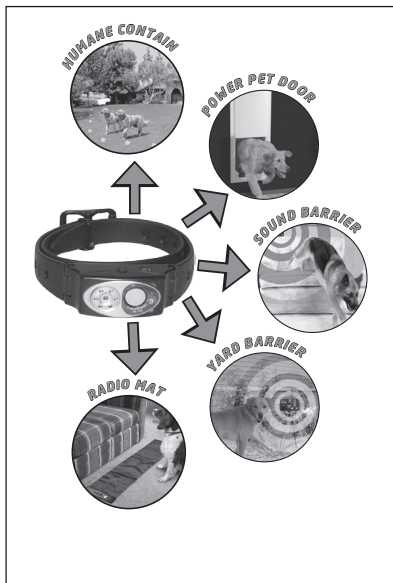

#### Model RX-10 Optional Multi-Function Collar

Our ingenious Model RX-10 Multi-function Collar combines the ultrasonic transmitter function of the Ultrasonic model pet collar above with our radio receiver and shock stimulus technology to operate ALL our products including:

#### TOTAL PET CONTROL™ COMPATIBLE

- POWER PET Fully Automatic Pet Doors
- SOUND BARRIER Non-Shock, Indoor Sonic Fence
- YARD BARRIER Non-Shock Outdoor Sonic Fence
- HUMANE CONTAIN Electronic Pet Fence
- RADIO MAT Electronic Scat Pad

You may add any of these collars to your POWER PET Door order to configure your own custom electronic pet care system!

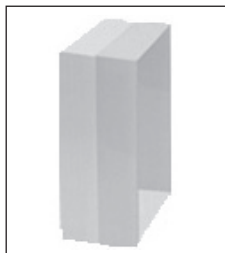

**Wall Adapter Tunnel:** Install your POWER PET™ door on any wall in one easy step with our convenient WALL ADAPTER TUNNEL accessory which extends the passageway and provides a sealed professional installation. It fits snugly into the POWER PET™ door main frame on one side of the wall, and the POWER PET™ outside frame on the other side. Adapts to any wall thickness from 4" to 8" thick.



**Rechargeable Backup Battery:** Install this heavy duty, long life, sealed 12 volt rechargeable battery in your POWER PET™ door to provide back-up power in case of an AC power failure. Provides hundreds of door openings to let your pet in or out until power returns. Automatically recharges in your door when power is restored.



**Battery Charger Kit:** For battery powering of the POWER PET™ Door in installations where AC power is not available. This kit includes a battery charger, rechargeable battery and an AC adapter. Simply charge the battery for 12 hours and insert it in the door to provide one to four weeks of normal operation. For the ultimate in convenience we recommend that you purchase this kit and one extra rechargeable battery above. Use one battery in your POWER PET™ door and keep the other in the charger. When your door battery runs down just swap in less than 30 seconds!

## TOTAL PET CONTROL ACCESSORIES:



### **SOUND BARRIER**

Model SBR-1 Indoor Sonic alarm keeps your pet off furniture, away from the kitchen table or out of an entire room. Operated from your pet's MS-4 or MS-5 transmitter included with your POWER PET Door. Also, operated by the optional RC-7000X collar. Order one for each pet restricted area.



### **YARD BARRIER**

Model YBR-1 Outdoor Sonic Alarm keeps your pet out of the garden, away from the trash and out of restricted areas with a wall of sound. Operated from your pet's standard MS-4 transmitter included with your POWER PET Door. Also, operated by the optional RC-7000X collar. Order one for each part of your yard where pets don't belong.



### **HUMANE CONTAIN**

Model HC-7000X Simply, the Most Advanced, Most Effective, Most Humane electronic pet fence made. Complete Electronic Fence Super System includes one Model RC-7000X Multi-Function Pet Collar that controls your POWER PET Door and every other TOTAL PET CONTROL™ COMPATIBLE product we make. Order additional collars for additional pets.



### **RADIO MAT**

Model RM-1TX Radio Controlled Scat Pad, Keeps Fido off the furniture! Radio signal emitted by the paw pad triggers a shock at Fido's collar. Also works in non-shock, sound only mode. Requires one Model RC-7000X Multi-Function Pet Collar that controls your POWER PET Door and all our TOTAL PET CONTROL™ COMPATIBLE products. Order one pad for every piece of furniture or other area where Fido doesn't belong. Order additional collars for additional pets.

# **TROUBLESHOOTING GUIDE**

For each problem, start with 1st solution, then 2nd, etc., until solved.

<b>PROBLEM</b>	<b>SOLUTIONS</b>
<i>While opening, door stops rising and all lights turn off or blink</i>	<ol style="list-style-type: none"><li>1) Replace power supply</li><li>2) Replace motor</li></ol>
<i>Door panel goes up and down without stopping</i>	<ol style="list-style-type: none"><li>1) Replace main wire harness</li><li>2) Replace main circuit board</li></ol>
<i>Very short range on both sensors</i> <i>Outside sensor good, but inside sensor yields short or no range</i> <i>Inside sensor good, but outside sensor yields short or no range</i> <i>Manual button works, but inside and outside sensors yield short or no range</i> <i>Manual button works, but door is not triggered by collar</i>	<ol style="list-style-type: none"><li>1) Replace sensor cable</li><li>2) Replace main circuit board</li></ol>
<i>Door goes up too slowly</i> <i>Door sticks at top</i>	<ol style="list-style-type: none"><li>1) Loosen mounting screws slightly</li><li>2) Clean sliding door with soap and water, then spray with dry lubricant</li><li>3) Replace motor assembly</li><li>4) Replace main circuit board</li></ol>
<i>Door sometimes opens by itself</i>	<ol style="list-style-type: none"><li>1) Reduce range settings on front panel</li></ol>
<i>Door does not open with manual button or collar</i>	<ol style="list-style-type: none"><li>1) Replace main circuit board</li></ol>
<i>Multiple collar failures</i>	<ol style="list-style-type: none"><li>1) Upgrade to MS-4 or MS-5 collar</li></ol>
<i>Range is difficult to adjust to less than five or six feet</i>	<ol style="list-style-type: none"><li>1) Replace main circuit board</li></ol>

If replacing an internal component, here are the workings of the door you will see after removing the back of the door frame.

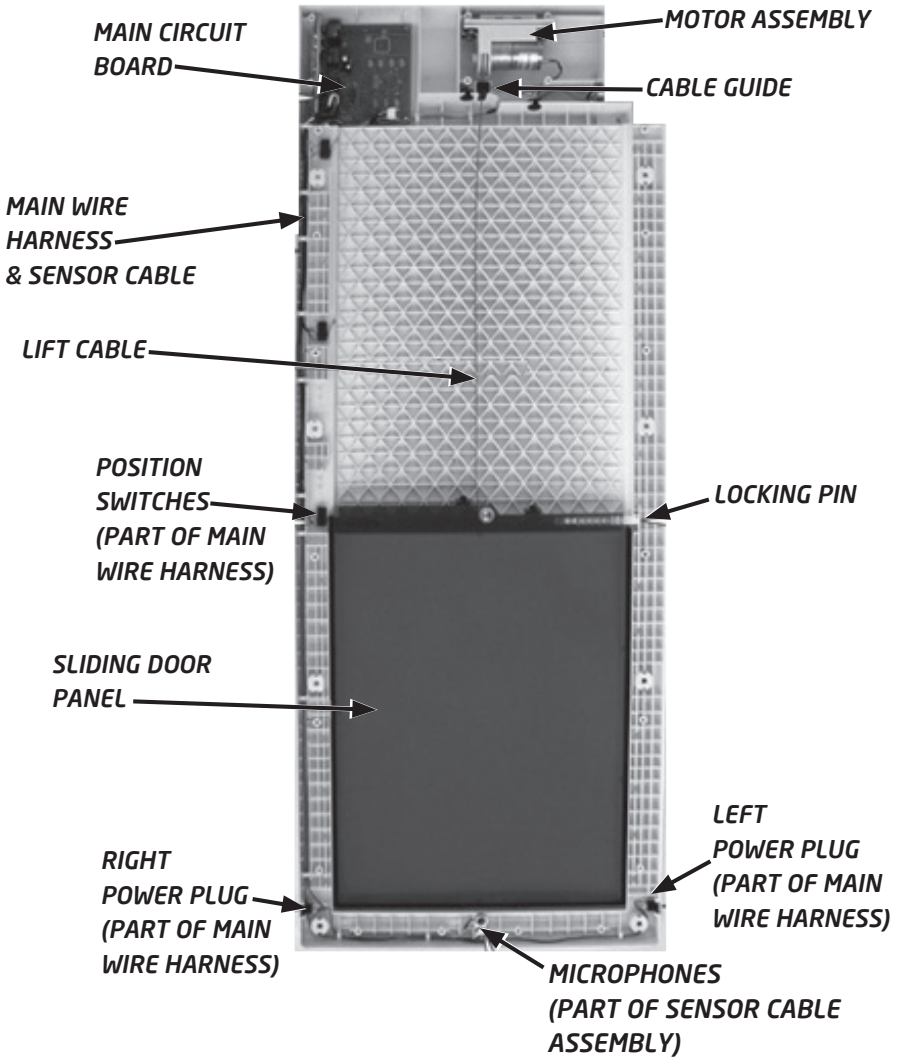

**ORDER INFORMATION**

To order extra collars and accessories please visit our website at **[www.hightechpet.com](http://www.hightechpet.com)** or call **1 (800) 255-1279**



**High Tech Pet Products, Inc.**  
2476 Palma Drive, Suite A  
Ventura, CA 93003  
[www.hightechpet.com](http://www.hightechpet.com)