

DORMER  PRAMET

**CARBIDE
ROTARY BURRS**

2020





CARBIDE ROTARY BURRS

EXPANDED RANGE 2020

Our range of carbide rotary burrs is a high quality and comprehensive program. This includes a variety of designs and shapes to offer an ideal option for the majority of applications in all major industry segments.

NEW

We have added to our assortment with a new line of burrs for Superalloys and bolt removal.

FEATURES AND BENEFITS

- The combination of premium grade materials for both the shank and head, with the precise production process, results in the creation of a consistent and secure program of tools.
- Material specific designs offer improved performance and up to 50% higher metal removal rates over standard carbide burrs.

NEW

- Our alloy specific range has been designed to meet the most demanding metal finishing needs on nickel and titanium components in high tech industries, such as aerospace and power generation.

SHANK

- Toughened and hardened steel shanks
- Provides rigidity and strength
- Prevents bending and reduces vibration, resulting in improved tool life
- Ground to h6 (carbide) and h7 (steel) for improved holding

BRAZING

- Special brazing elements provide excellent braze strength
- Excellent impact strength to withstand high forces
- Able to withstand higher temperature without failing

CUT STYLES



ST

ST CUT

First choice for high performance machining of **Steels**

- Material specific chip breaker design for higher machining output on steel parts
- Positive geometry, ensures smooth surface finish
- Creates less temperature which helps increase tool life



VA

VA CUT

First choice for high performance machining of **Stainless steels**

- Sharp cutting geometry, reducing the onset of work-hardening
- Increases metal removal rate



AL

ALUMINIUM CUT

First choice for **Non ferrous materials and Plastics**

- High helix and large flute volume for rapid metal removal



BALL NOSE GEOMETRY

- Skip flute grinding
- Increased strength at the centre
- Reduced chance of swarf congestion
- Improved cutting action closer to the centre



Skip

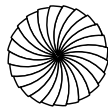

Normal

TiAlN COATING

- Increased tool life in difficult conditions
- Reduced friction improves swarf evacuation
- Helps resist “built-up edge” common with cutting tools with small flute volumes

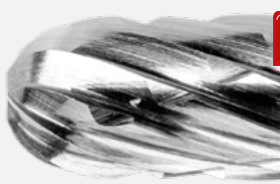

NEW

AS

AS CUT

First choice for **Superalloys**

- Ergonomic
- High quality surface finish
- Fast and smooth cutting action



GRP

GRP CUT

First choice for **Fibreglass and Composite materials**

- Available with Drill Point and End Mill styles
- Designed to reduce splintering and improve entry and exit surface quality



DC

DOUBLE CUT

First choice for **General machining**

- Improves ease of control
- Increases metal removal rate

CARBIDE ROTARY BURRS

FOR BOLT REMOVAL

NEW

A specially designed range of burrs to prepare the surface of broken bolts to improve drill location and prevent damaging the threaded hole and component.

FEATURES AND BENEFITS

- Specific diameters and cutting lengths to suit various thread diameters
- Long reach and tapered shanks for easy access
- Developed cutting geometry for machining high tensile materials
- Reduces potential damage to existing threaded holes
- Improves drill location, ensuring damaged bolt is drilled on centre
- Prevents potential scrappage of component
- Highly consistent quality

OPERATIONS

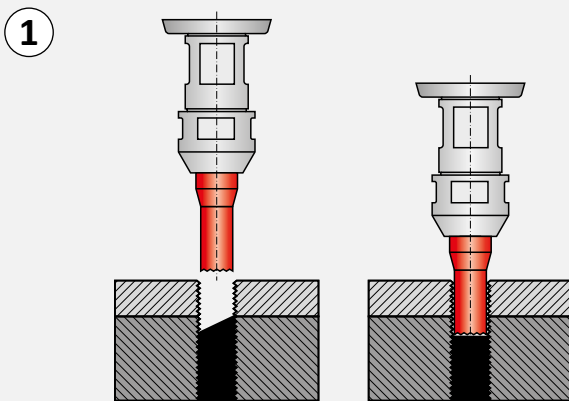

CUT STYLES

NEW

PLAIN CYLINDER WITH END CUT

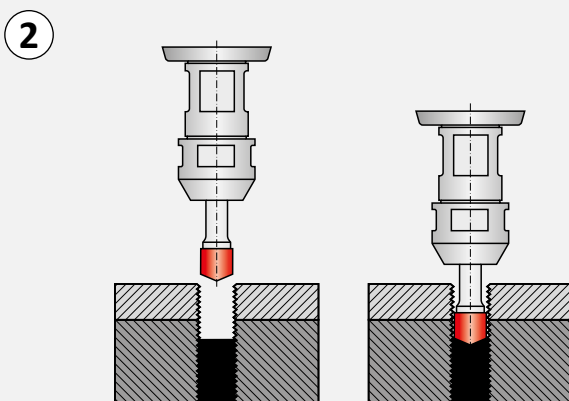

NEW

150° COUNTERSINK



HOW TO USE THE TOOLS

- Choose the correct size burr for the broken bolt
- Use a right-handed die grinder
- Ensure the burr is perpendicular to the broken bolt
- Grind the broken surface flat – Operation ①
- Grind into the prepared surface to form a countersink location at the centre point of the bolt – Operation ②



WORKPIECE MATERIAL GROUPS (WMG)

ISO to select a cutting grade and geometry for a broad range of workpiece materials

General definition
i.e. steel, stainless steel...

P M K N S H

Subgroup to navigate and select a tool by suitability for more specific range of workpiece materials

Definition by structure/composition
i.e. plain carbon steel, alloy steel...

P M K N S H

P1

P2

P3

P4

WMG to select and provide cutting conditions within a bandwidth of $\pm 10\%$

Definition by hardness/ultimate tensile strength
i.e. $160 < 220\text{HB}$, $620 < 900 \text{ n/mm}^2 \dots$

P

P1 P1.1 P1.2 P1.3

P2 P2.1 P2.2 P2.3

P3 P3.1 P3.2 P3.3

P4 P4.1 P4.2 P4.3

ABOUT DORMER PRAMET'S WORKPIECE MATERIAL CLASSIFICATION

Workpiece material groups ("WMG") are used to support easy and reliable selection of the right cutting tool and starting values for machining conditions in particular applications.

Dormer Pramet classifies workpiece materials into six differently coloured groups;

- **Blue:** Steel and cast steel (P-group)
- **Yellow:** Stainless steel (M-group)
- **Red:** Cast iron (K-group)
- **Green:** Non-ferrous metals (N-group)
- **Orange:** High-temperature alloys (S-group)
- **Grey:** Hardened materials (H-group)

Each of these are divided into subgroups on the basis of their structure and/or composition. For example, P-group steel and cast steel is split into four subgroups, namely;

- P1 – **Free machining steel**
- P2 – **Plain carbon steel**
- P3 – **Alloy steel**
- P4 – **Tool steel**

A final division includes material properties, such as hardness and ultimate tensile strength. This is to provide our customers with a complete tool recommendation, including starting values for cutting speed and feed.

The table on the next page includes a description of each workpiece material group, as well as examples of commonly used designations

ISO	WMG (Workpiece Material Groups)		Ultimate tensile strength Mpa [N/mm ²]	Old Dormer AMG	Old Pramet ISO
P	P1	P1.1 Free machining sulfurized carbon steel with a hardness of < 220 HB	≤ 760	1.1	P1
		P1.2 Free machining sulfurized and phosphorized carbon steel with a hardness of < 180 HB	≤ 620	1.1	P1
		P1.3 Free machining sulfurized/phosphorized and leaded carbon steel with a hardness of < 160 HB	≤ 550	1.1	P1
	P2	P2.1 Plain low carbon steel containing < 0.25%C with a hardness of < 180 HB	≤ 620	1.2	P2
		P2.2 Plain medium carbon steel containing < 0.55%C with a hardness of < 240 HB	≤ 830	1.3	P2
		P2.3 Plain high carbon steel containing > 0.55%C, with a hardness of < 300 HB	≤ 1030	1.5	P3
	P3	P3.1 Alloy steel with a hardness of < 180 HB	≤ 620	1.4	P3
		P3.2 Alloy steel with a hardness of 180 – 260 HB	> 620 ≤ 900	1.4	P3
		P3.3 Alloy steel with a hardness of 260 – 360 HB	> 900 ≤ 1240	1.5	P4
	P4	P4.1 Tool steel with a hardness of < 26 HRC	≤ 900	1.4	P3
		P4.2 Tool steel with a hardness of 26 – 39 RC	> 900 ≤ 1240	1.5	P4
		P4.3 Tool steel with a hardness of 39 – 45 HRC	> 1250 ≤ 1450	1.6	H1
	M	M1	M1.1 Stainless steel, ferritic with a hardness of < 160 HB	≤ 520	2.1
M1.2 Stainless steel, ferritic with a hardness of 160 – 220 HB			> 520 ≤ 700	2.1	M1
M2.1 Stainless steel, martensitic with a hardness of < 200 HB			≤ 670	2.3	M2
M2		M2.2 Stainless steel, martensitic with a hardness of 200 – 280 HB	> 670 ≤ 950	2.3	M2
		M2.3 Stainless steel, martensitic with a hardness of 280 – 380 HB	> 950 ≤ 1300	2.4	M2
		M3.1 Stainless steel, austenitic with a hardness of < 200 HB	≤ 750	2.2	M3
M3		M3.2 Stainless steel, austenitic with a hardness of 200 – 260 HB	> 750 ≤ 870	2.2	M3
		M3.3 Stainless steel, austenitic with a hardness of 260 – 300 HB	> 870 ≤ 1040	2.2	M3
		M4	M4.1 Stainless steel, austenitic-ferritic or super-austenitic with a hardness of < 300 HB	≤ 990	2.3
M4.2 Stainless steel, precipitation hardening austenitic with a hardness of 300 – 380 HB	≤ 1320		2.4	M4	
K	K1	K1.1 Gray iron, ferritic or ferritic-pearlitic with a hardness of < 180 HB	≤ 190	3.1	K1
		K1.2 Gray iron, ferritic-pearlitic or pearlitic with a hardness of 180 – 240 HB	> 190 ≤ 310	3.2	K1
		K1.3 Gray iron, pearlitic with a hardness of 240 – 280 HB	> 310 ≤ 390	3.2	K1
	K2	K2.1 Malleable iron, ferritic with a hardness of < 160 HB	≤ 400	3.3	K2
		K2.2 Malleable iron, ferritic or pearlitic with a hardness of 160 – 200 HB	> 400 ≤ 550	3.3	K2
		K2.3 Malleable iron, pearlitic with a hardness of 200 – 240 HB	> 550 ≤ 660	3.4	K2
	K3	K3.1 Ductile (nodular/spheroidal) iron, ferritic with a hardness of < 180 HB	≤ 560	3.3	K3
		K3.2 Ductile (nodular/spheroidal) iron, ferritic or pearlitic with a hardness of 180 – 220 HB	> 560 ≤ 680	3.3	K4
		K3.3 Ductile (nodular/spheroidal) iron, pearlitic with a hardness of 220 – 260 HB	> 680 ≤ 800	3.4	K4
	K4	K4.1 Austenitic cast iron with a hardness of < 180 HB	≤ 610		
		K4.2 Austenitic cast iron with a hardness of 180 – 240HB	> 610 ≤ 840		
		K4.3 Austempered ductile iron with a hardness of 240 – 280 HB	> 840 ≤ 980		
		K4.4 Austempered ductile iron with a hardness of 280 – 320 HB	> 980 ≤ 1130		
		K4.5 Austempered ductile iron with a hardness of 320 – 360 HB	> 1130 ≤ 1280		
	K5	K5.1 Vermicular, compacted graphite iron with a hardness of < 180 HB			
		K5.2 Vermicular, compacted graphite iron with a hardness of 180 – 220 HB			
		K5.3 Vermicular, compacted graphite iron with a hardness of 220 – 260 HB			
	N	N1	N1.1 Pure aluminium and wrought aluminium alloys with a hardness of < 60 HB	≤ 240	7.1
N1.2 Wrought aluminium alloys with a hardness of 60 – 100 HB			> 240 ≤ 400	7.1	N1
N1.3 Wrought aluminium alloys with a hardness of 100 – 150 HB			> 400 ≤ 590	7.2	N2
N2		N2.1 Cast aluminium alloys with a hardness of < 75 HB	≤ 240	7.3	N1
		N2.2 Cast aluminium alloys with a hardness of 75 – 90 HB	> 240 ≤ 270	7.3	N1
		N2.3 Cast aluminium alloys with a hardness of 90 < 140 HB	> 270 ≤ 440	7.3	N2
N3		N3.1 Free-cutting copper-alloys materials with excellent machining properties		6.3	N3
		N3.2 Short-chip copper-alloys with good to moderate machining properties		6.2	N3
		N3.3 Electrolytic copper and long-chip copper-alloys with moderate to poor machining properties		6.1	N4
N4		N4.1 Thermoplastic polymers		8.1	
		N4.2 Thermosetting polymers		8.2	
	N4.3 Reinforced polymers or composites		8.3		
S	S1	S1.1 Titanium or titanium alloys, with a hardness of < 200 HB	≤ 660	4.1	S1
		S1.2 Titanium alloys, with a hardness of 200 – 280 HB	> 660 ≤ 950	4.2	S1
		S1.3 Titanium alloys, a hardness of 280 – 360 HB	> 950 ≤ 1200	4.3	S1
	S2	S2.1 High-temperature Fe-based alloys with a hardness of < 200 HB	≤ 690		S2
		S2.2 High-temperature Fe-based alloys with a hardness of 200 – 280 HB	> 690 ≤ 970		S2
	S3	S3.1 High-temperature Ni-based alloys with a hardness of < 280 HB	≤ 940	5.2	S3
		S3.2 High-temperature Ni-based alloys with a hardness of 280 – 360 HB	> 940 ≤ 1200	5.3	S3
	S4	S4.1 High-temperature Co-based alloys with a hardness of < 240HB	≤ 800		S4
S4.2 High-temperature Co-based alloys with a hardness of 240 – 320 HB		> 800 ≤ 1070		S4	
H	H1	H1.1 Chilled cast iron with a hardness of < 400 HB			
	H2	H2.1 Hardened cast iron with a hardness < 55 HRC			H2
		H2.2 Hardened cast iron with a hardness > 55 HRC			H2
	H3	H3.1 Hardened steel with a hardness of < 51 HRC		1.7	H3
		H3.2 Hardened steel with a hardness of 51 – 55 HRC		1.7	H3
	H4	H4.1 Hardened steel with a hardness of 55 – 59 HRC		1.8	H4
	H4.2 Hardened steel with a hardness of > 59 HRC		1.8	H4	

		HM	HM	HM	HM	HM	HM	HM	HM	HM	HM	HM	HM	HM	HM	HM	
		A	A	A	A	A	A	B	B	B	B	C	C	C	C	C	
		DC	DC	ST	VA	AL	AS	DC	DC	ST	AL	DC	DC	ST	VA	AL	AS
		P801	P801C	P701	P601	P831	P501	P803	P803C	P703	P833	P805	P805C	P705	P605	P835	P505
		3.00-16.00	3.00-12.70	6.00-12.70	3.00-12.70	6.00-12.70	3.00	3.00-16.00	3.00-12.70	6.00-12.70	6.00-12.70	3.00-16.00	3.00-12.70	6.00-12.70	3.00-12.70	6.00-12.70	3.00
							NEW										NEW
ISO 513																	
P	P1	■	■	■				■	■	■		■	■	■			
	P2	■	■	■				■	■	■		■	■	■			
	P3	■	■	■				■	■	■		■	■	■			
	P4	■	■	■				■	■	■		■	■	■			
M	M1	■	■		■	▣		■	■		▣	■	■		■	▣	
	M2	■	■		■	▣		■	■		▣	■	■		■	▣	
	M3	■	■		■			■	■			■	■		■		
	M4	■	■		■			■	■			■	■		■		
K	K1	■	■					■	■			■	■				
	K2	■	■					■	■			■	■				
	K3	■	■					■	■			■	■				
	K4	■	■					■	■			■	■				
	K5	■	■					■	■			■	■				
N	N1					■					■					■	
	N2					■					■					■	
	N3					▣					▣					▣	
	N4					■					■					■	
S	S1	■	■			▣	■	■	■		▣	■	■			▣	■
	S2	■	■				■	■	■			■	■				■
	S3	■	■				■	■	■			■	■				■
	S4	■	■				■	■	■			■	■				■
H	H1	■	■					■	■			■	■				
	H2	■	■					■	■			■	■				
	H3	■	■					■	■			■	■				
	H4	■	■					■	■			■	■				

		HM	HM	HM	HM	HM	HM	HM	HM	HM	HM	HM	HM	HM	HM		
		D	D	D	D	D	E	E	E	E	F	F	F	F	F		
			TiAlN								TiAlN						
		DC	DC	ST	VA	AL	AS	DC	ST	VA	AS	DC	DC	ST	VA	AL	AS
		P807	P807C	P707	P607	P837	P507	P809	P709	P609	P509	P811	P811C	P711	P611	P841	P511
		3.00 – 16.00	3.00 – 12.70	6.00 – 12.70	3.00 – 12.70	6.00 – 12.70	3.00	3.00 – 16.00	12.70	8.00 – 12.70	3.00	3.00 – 16.00	3.00 – 12.70	6.00 – 12.70	3.00 – 12.70	6.00 – 12.70	3.00
							NEW				NEW						NEW
ISO 513		19	19	20	20	20	20	21	22	22	22	23	23	24	24	24	24
P	P1	■	■	■				■	■			■	■	■			
	P2	■	■	■				■	■			■	■	■			
	P3	■	■	■				■	■			■	■	■			
	P4	■	■	■				■	■			■	■	■			
M	M1	■	■		■	▣		■		■		■	■		■	▣	
	M2	■	■		■	▣		■		■		■	■		■	▣	
	M3	■	■		■			■		■		■	■		■		
	M4	■	■		■			■		■		■	■		■		
K	K1	■	■					■				■	■				
	K2	■	■					■				■	■				
	K3	■	■					■				■	■				
	K4	■	■					■				■	■				
	K5	■	■					■				■	■				
N	N1					■										■	
	N2					■										■	
	N3					▣										▣	
	N4					■										■	
S	S1	■	■			▣	■	■			■	■	■			▣	■
	S2	■	■				■	■			■	■	■				■
	S3	■	■				■	■			■	■	■				■
	S4	■	■				■	■			■	■	■				■
H	H1	■	■					■				■	■				
	H2	■	■					■				■	■				
	H3	■	■					■				■	■				
	H4	■	■					■				■	■				

■ Main application ▣ Secondary application

		HM	HM	HM	HM	HM	HM	HM	HM	HM	HM	HM	HM	HM	HM	HM		
		G	G	G	G	G	H	H	H	H	H	J	K	L	L	L		
			TiAlN					TiAlN							TiAlN			
											60°	90°						
		DC	DC	ST	VA	AS	DC	DC	ST	VA	AS	DC	DC	DC	DC	ST	VA	
		P813	P813C	P713	P613	P513	P815	P815C	P715	P615	P515	P817	P819	P821	P821C	P721	P621C	
		3.00-16.00	3.00-12.70	6.00-12.70	6.00-12.70	3.00	3.00-16.00	8.00-12.70	8.00-12.70	8.00-12.70	3.00	3.00-16.00	3.00-16.00	3.00-16.00	3.00-12.70	10.00-12.70	8.00-12.70	
						NEW					NEW							
ISO 513																		
P	P1	■	■	■			■	■	■			■	■	■	■	■		
	P2	■	■	■			■	■	■			■	■	■	■	■	■	
	P3	■	■	■			■	■	■			■	■	■	■	■	■	
	P4	■	■	■			■	■	■			■	■	■	■	■	■	
M	M1	■	■		■		■	■		■		■	■	■	■		■	
	M2	■	■		■		■	■		■		■	■	■	■		■	
	M3	■	■		■		■	■		■		■	■	■	■		■	
	M4	■	■		■		■	■		■		■	■	■	■		■	
K	K1	■	■				■	■				■	■	■	■			
	K2	■	■				■	■				■	■	■	■			
	K3	■	■				■	■				■	■	■	■			
	K4	■	■				■	■				■	■	■	■			
	K5	■	■				■	■				■	■	■	■			
N	N1																	
	N2																	
	N3																	
	N4																	
S	S1	■	■			■	■	■			■	■	■	■	■			
	S2	■	■			■	■	■			■	■	■	■	■			
	S3	■	■			■	■	■			■	■	■	■	■			
	S4	■	■			■	■	■			■	■	■	■	■			
H	H1	■	■				■	■				■	■	■	■			
	H2	■	■				■	■				■	■	■	■			
	H3	■	■				■	■				■	■	■	■			
	H4	■	■				■	■				■	■	■	■			

		HM	HM	HM	HM	HM	HM	HM	HM			
		L	L	M	M	N						
						135°	180°		150°			
		AL	AS	DC	AS	DC	GRP	GRP	BR	BR		
		P842	P521	P823	P523	P825	P843	P844	P100	P101	P880	P890
		6.00 – 12.70	3.00	3.00 – 16.00	3.00	3.00 – 16.00	3.00 – 8.00	3.00 – 8.00	4.90 – 10.70	4.90 – 10.70	Set	Set
			NEW		NEW			NEW	NEW	NEW		
ISO 513		32	32	33	34	35	36	37	38	39	40	40
P	P1			■		■			■	■		
	P2			■		■			■	■		
	P3			■		■			■	■		
	P4			■		■			■	■		
M	M1	▣		■		■			■	■		
	M2	▣		■		■			■	■		
	M3			■		■			■	■		
	M4			■		■						
K	K1			■		■						
	K2			■		■						
	K3			■		■						
	K4			■		■						
	K5			■		■						
N	N1	■										
	N2	■										
	N3	▣										
	N4	■					■	■				
S	S1	▣	■	■	■	■						
	S2		■	■	■	■						
	S3		■	■	■	■						
	S4		■	■	■	■						
H	H1			■		■						
	H2			■		■						
	H3			■		■						
	H4			■		■						

■ Main application ▣ Secondary application

AL

DC

ISO		RPM						
		DC [mm]						
		3	6	8	10	12	16	20
P	min	64 000	32 000	24 000	20 000	16 000	12 000	10 000
	max	83 000	42 000	32 000	25 000	21 000	16 000	13 000
M	min	45 000	23 000	17 000	14 000	12 000	9 000	7 000
	max	64 000	32 000	24 000	20 000	16 000	12 000	10 000
K	min	58 000	29 000	22 000	19 000	15 000	11 000	9 000
	max	77 000	39 000	29 000	23 000	20 000	15 000	12 000
N	min	64 000	32 000	24 000	20 000	16 000	12 000	10 000
	max	96 000	48 000	36 000	29 000	24 000	18 000	15 000
S	min	45 000	23 000	17 000	14 000	12 000	9 000	7 000
	max	58 000	29 000	22 000	18 000	15 000	11 000	9 000
H	min	51 000	26 000	20 000	16 000	13 000	10 000	8 000
	max	71 000	36 000	27 000	22 000	18 000	14 000	11 000

ST

BR

ISO		RPM				
		DC [mm]				
		3	6	8	10	12
P	min	100 000	65 000	60 000	55 000	35 000
	max	60 000	45 000	35 000	30 000	20 000

VA

BR

ISO		RPM				
		DC [mm]				
		3	6	8	10	12
M	min	100 000	65 000	60 000	55 000	35 000
	max	60 000	30 000	25 000	20 000	15 000

GRP

ISO		RPM		
		DC [mm]		
		3	6	8
N4	min	25 000	20 000	18 000
	max	30 000	25 000	22 000

AS

ISO		RPM
		DC [mm]
		3
S	min	60 000
	max	80 000

P801 P801C

Rotary Burr – Cylinder without endcut. Brazed above 6.00 mm.

P801 P801C	P1.1	P1.2	P1.3	P2.1	P2.2	P2.3	P3.1	P3.2	P3.3	P4.1	P4.2	P4.3	M1.1	M1.2	M2.1	M2.2	M2.3
	■	■	■	■	■	■	■	■	■	■	■	■	■	■	■	■	■
	M3.1	M3.2	M3.3	M4.1	M4.2	K1.1	K1.2	K1.3	K2.1	K2.2	K2.3	K3.1	K3.2	K3.3	K4.1	K4.2	K4.3
	■	■	■	■	■	■	■	■	■	■	■	■	■	■	■	■	■
	K4.4	K4.5	K5.1	K5.2	K5.3	N3.1	N3.2	N3.3	S1.1	S1.2	S1.3	S2.1	S2.2	S3.1	S3.2	S4.1	S4.2
	■	■	■	■	■	■	■	■	▣	■	■	■	■	■	■	■	■
	H1.1	H2.1	H2.2	H3.1	H3.2	H4.1	H4.2										

P801	HM	A				DC	
P801C	HM	A			TiAlN	DC	





DC	DCON MS h7	APMX	OAL	P801	P801C
[mm]	[mm]	[mm]	[mm]		
3.00	3	14	38	P8013.0X3.0 ¹⁾	P801C3.0X3.0 ¹⁾
6.30	3	12.7	45	P8016.3X3.0	
6.00	6	18	50	P8016.0X6.0 ¹⁾	P801C6.0X6.0 ¹⁾
8.00	6	19	64	P8018.0X6.0	P801C8.0X6.0
9.60	6	19	64	P8019.6X6.0	P801C9.6X6.0
12.70	6	25	70	P80112.7X6.0	P801C12.7X6.0
16.00	6	25	70	P80116.0X6.0	

¹⁾ DCON MS tolerance h6

P701

P601

P831

P501

Rotary Burr – Cylinder without endcut. Brazed above 6.00 mm.

Rotary Burr – Cylinder without endcut.

P701	P1.1	P1.2	P1.3	P2.1	P2.2	P2.3	P3.1	P3.2	P3.3	P4.1	P4.2	P4.3					
	■	■	■	■	■	■	■	■	■	■	■	■					
P601	M1.1	M1.2	M2.1	M2.2	M2.3	M3.1	M3.2	M3.3	M4.1	M4.2							
	■	■	■	■	■	■	■	■	■	■							
P831	M1.1	M1.2	M2.1	M2.2	N1.1	N1.2	N1.3	N2.1	N2.2	N2.3	N3.2	N4.1	N4.2	N4.3	S1.1		
	☐	☐	☐	☐	■	■	■	■	■	■	☐	■	■	■	☐		
P501	S1.1	S1.2	S1.3	S2.1	S2.2	S3.1	S3.2	S4.1	S4.2								
	■	■	■	■	■	■	■	■	■								

P701	HM	A					ST		
P601	HM	A					VA		
P831	HM	A					AL		
P501	HM	A					AS		



P701	P601	P831	P501
6.00 – 12.70	3.00 – 12.70	6.00 – 12.70	3.00







DC	DCON MS h7	APMX	OAL	P701	P601	P831	P501
[mm]	[mm]	[mm]	[mm]				
3.00	3	12	38				P5013.0X3.0 ¹⁾
3.00	3	14	38		P6013.0X3.0 ¹⁾		
6.30	3	12.7	45		P6016.3X3.0 ¹⁾		
6.00	6	18	50	P7016.0X6.0 ¹⁾	P6016.0X6.0	P8316.0X6.0 ¹⁾	
8.00	6	19	64	P7018.0X6.0	P6018.0X6.0		
9.60	6	19	64	P7019.6X6.0	P6019.6X6.0	P8319.6X6.0	
12.70	6	25	70	P70112.7X6.0	P60112.7X6.0	P83112.7X6.0	

¹⁾ DCON MS tolerance h6

P803 P803C

Rotary Burr – Cylinder with endcut. Brazed above 6.00 mm.

P803 P803C	P1.1	P1.2	P1.3	P2.1	P2.2	P2.3	P3.1	P3.2	P3.3	P4.1	P4.2	P4.3	M1.1	M1.2	M2.1	M2.2	M2.3
	■	■	■	■	■	■	■	■	■	■	■	■	■	■	■	■	■
	M3.1	M3.2	M3.3	M4.1	M4.2	K1.1	K1.2	K1.3	K2.1	K2.2	K2.3	K3.1	K3.2	K3.3	K4.1	K4.2	K4.3
	■	■	■	■	■	■	■	■	■	■	■	■	■	■	■	■	■
	K4.4	K4.5	K5.1	K5.2	K5.3	N3.1	N3.2	N3.3	S1.1	S1.2	S1.3	S2.1	S2.2	S3.1	S3.2	S4.1	S4.2
	■	■	■	■	■	■	■	■	■	■	■	■	■	■	■	■	■
	H1.1	H2.1	H2.2	H3.1	H3.2	H4.1	H4.2										
	■	■	■	■	■	■	■										

P803	HM	B					DC		 40	 40
P803C	HM	B			TiAlN		DC		 40	





DC	DCON MS h7	APMX	OAL	P803	P803C
[mm]	[mm]	[mm]	[mm]		
3.00	3	14	38	P8033.0X3.0 ¹⁾	P803C3.0X3.0 ¹⁾
6.30	3	12.7	45	P8036.3X3.0	
6.00	6	18	50	P8036.0X6.0 ¹⁾	P803C6.0X6.0 ¹⁾
8.00	6	19	64	P8038.0X6.0	P803C8.0X6.0
9.60	6	19	64	P8039.6X6.0	P803C9.6X6.0
12.70	6	25	70	P80312.7X6.0	P803C12.7X6.0
16.00	6	25	70	P80316.0X6.0	

¹⁾ DCON MS tolerance h6

P703 P833

Rotary Burr – Cylinder with endcut. Brazed above 6.00 mm.

P703	P1.1	P1.2	P1.3	P2.1	P2.2	P2.3	P3.1	P3.2	P3.3	P4.1	P4.2	P4.3						
	■	■	■	■	■	■	■	■	■	■	■	■						
P833	M1.1	M1.2	M2.1	M2.2	N1.1	N1.2	N1.3	N2.1	N2.2	N2.3	N3.2	N4.1	N4.2	N4.3	S1.1			
	☑	☑	☑	☑	■	■	■	■	■	■	■	■	■	■	■	☑		

P703	HM	B					ST		
P833	HM	B					AL		





DC	DCON MS h7	APMX	OAL	P703	P833
[mm]	[mm]	[mm]	[mm]		
6.00	6	18	50	P7036.0X6.0 ¹⁾	P8336.0X6.0 ¹⁾
8.00	6	19	64	P7038.0X6.0	
9.60	6	19	64	P7039.6X6.0	P8339.6X6.0
12.70	6	25	70	P70312.7X6.0	P83312.7X6.0

¹⁾ DCON MS tolerance h6

P805 P805C

Rotary Burr – Ball Nosed Cylinder. Brazed above 6.00 mm.

P805 P805C	P1.1	P1.2	P1.3	P2.1	P2.2	P2.3	P3.1	P3.2	P3.3	P4.1	P4.2	P4.3	M1.1	M1.2	M2.1	M2.2	M2.3
	■	■	■	■	■	■	■	■	■	■	■	■	■	■	■	■	■
	M3.1	M3.2	M3.3	M4.1	M4.2	K1.1	K1.2	K1.3	K2.1	K2.2	K2.3	K3.1	K3.2	K3.3	K4.1	K4.2	K4.3
	■	■	■	■	■	■	■	■	■	■	■	■	■	■	■	■	■
	K4.4	K4.5	K5.1	K5.2	K5.3	N3.1	N3.2	N3.3	S1.1	S1.2	S1.3	S2.1	S2.2	S3.1	S3.2	S4.1	S4.2
	■	■	■	■	■	■	■	■	▣	■	■	■	■	■	■	■	■
	H1.1	H2.1	H2.2	H3.1	H3.2	H4.1	H4.2										
	■	■	■	■	■	■	■										

P805	HM	C				DC			
P805C	HM	C			TiAlN	DC			





DC	DCON MS h7	APMX	OAL	P805	P805C
[mm]	[mm]	[mm]	[mm]		
3.00	3	14	38	P8053.0X3.0 ¹⁾	P805C3.0X3.0 ¹⁾
6.30	3	12.7	45	P8056.3X3.0	
6.00	6	18	50	P8056.0X6.0 ¹⁾	P805C6.0X6.0 ¹⁾
8.00	6	19	64	P8058.0X6.0	P805C8.0X6.0
9.60	6	19	64	P8059.6X6.0	P805C9.6X6.0
12.70	6	25	70	P80512.7X6.0	P805C12.7X6.0
16.00	6	25	70	P80516.0X6.0	

¹⁾ DCON MS tolerance h6

P705

P605























P835

P505

Rotary Burr – Ball Nosed Cylinder. Brazed above 6.00 mm.

Rotary Burr – Ball Nosed Cylinder.

P705	P1.1	P1.2	P1.3	P2.1	P2.2	P2.3	P3.1	P3.2	P3.3	P4.1	P4.2	P4.3						
	■	■	■	■	■	■	■	■	■	■	■	■						
P605	M1.1	M1.2	M2.1	M2.2	M2.3	M3.1	M3.2	M3.3	M4.1	M4.2								
	■	■	■	■	■	■	■	■	■	■								
P835	M1.1	M1.2	M2.1	M2.2	N1.1	N1.2	N1.3	N2.1	N2.2	N2.3	N3.2	N4.1	N4.2	N4.3	S1.1			
	☑	☑	☑	☑	■	■	■	■	■	■	■	☑	■	■	■	☑		
P505	S1.1	S1.2	S1.3	S2.1	S2.2	S3.1	S3.2	S4.1	S4.2									
	■	■	■	■	■	■	■	■	■									

P705	HM	C					ST		 40 P880
P605	HM	C					VA		 40 P880
P835	HM	C					AL		
P505	HM	C					AS		 40 P880





DC	DCON MS h7	APMX	OAL	P705	P605	P835	P505
[mm]	[mm]	[mm]	[mm]				
3.00	3	14	38		P6053.0X3.0 ¹⁾		P5053.0X3.0 ¹⁾
6.30	3	12.7	45		P6056.3X3.0		
6.00	6	18	50	P7056.0X6.0 ¹⁾	P6056.0X6.0 ¹⁾	P8356.0X6.0 ¹⁾	
8.00	6	19	64	P7058.0X6.0	P6058.0X6.0		
9.60	6	19	64	P7059.6X6.0	P6059.6X6.0	P8359.6X6.0	
12.70	6	25	70	P70512.7X6.0	P60512.7X6.0	P83512.7X6.0	

¹⁾ DCON MS tolerance h6

P807 P807C

Rotary Burr – Ball. Brazed above 6.00 mm.

P807 P807C	P1.1	P1.2	P1.3	P2.1	P2.2	P2.3	P3.1	P3.2	P3.3	P4.1	P4.2	P4.3	M1.1	M1.2	M2.1	M2.2	M2.3
	■	■	■	■	■	■	■	■	■	■	■	■	■	■	■	■	■
	M3.1	M3.2	M3.3	M4.1	M4.2	K1.1	K1.2	K1.3	K2.1	K2.2	K2.3	K3.1	K3.2	K3.3	K4.1	K4.2	K4.3
	■	■	■	■	■	■	■	■	■	■	■	■	■	■	■	■	■
	K4.4	K4.5	K5.1	K5.2	K5.3	N3.1	N3.2	N3.3	S1.1	S1.2	S1.3	S2.1	S2.2	S3.1	S3.2	S4.1	S4.2
	■	■	■	■	■	■	■	■	▣	■	■	■	■	■	■	■	■
	H1.1	H2.1	H2.2	H3.1	H3.2	H4.1	H4.2										
	■	■	■	■	■	■	■										

P807	HM	D				DC		
P807C	HM	D			TiAIN	DC		



P807	P807C
3.00 – 16.00	3.00 – 12.70

DC	DCON MS h7	APMX	OAL	P807	P807C
[mm]	[mm]	[mm]	[mm]		
3.00	3	2.5	38	P8073.0X3.0 ¹⁾	P807C3.0X3.0 ¹⁾
4.00	3	3.4	38	P8074.0X3.0 ¹⁾	
6.30	3	5	38	P8076.3X3.0	
6.00	6	4.7	50	P8076.0X6.0 ¹⁾	P807C6.0X6.0 ¹⁾
8.00	6	6	52	P8078.0X6.0	P807C8.0X6.0
9.60	6	8	54	P8079.6X6.0	P807C9.6X6.0
12.70	6	11	56	P80712.7X6.0	P807C12.7X6.0
16.00	6	14	59	P80716.0X6.0	

¹⁾ DCON MS tolerance h6

P707

P607























P837

P507

Rotary Burr – Ball. Brazed above 6.00 mm.

Rotary Burr – Ball.

P707	P1.1	P1.2	P1.3	P2.1	P2.2	P2.3	P3.1	P3.2	P3.3	P4.1	P4.2	P4.3						
	■	■	■	■	■	■	■	■	■	■	■	■						
P607	M1.1	M1.2	M2.1	M2.2	M2.3	M3.1	M3.2	M3.3	M4.1	M4.2								
	■	■	■	■	■	■	■	■	■	■								
P837	M1.1	M1.2	M2.1	M2.2	N1.1	N1.2	N1.3	N2.1	N2.2	N2.3	N3.2	N4.1	N4.2	N4.3	S1.1			
	☐	☐	☐	☐	■	■	■	■	■	■	■	■	■	■	■	☐		
P507	S1.1	S1.2	S1.3	S2.1	S2.2	S3.1	S3.2	S4.1	S4.2									
	■	■	■	■	■	■	■	■	■									

P707	HM	D					ST		
P607	HM	D					VA		
P837	HM	D					AL		
P507	HM	D					AS		





P707	P607	P837	P507
			
6.00 – 12.70	3.00 – 12.70	6.00 – 12.70	 3.00

DC	DCON MS h7	APMX	OAL	P707	P607	P837	P507
[mm]	[mm]	[mm]	[mm]				
3.00	3	2.5	38		P6073.0X3.0 ¹⁾		P5073.0X3.0 ¹⁾
6.30	3	5	38		P6076.3X3.0		
6.00	6	4.7	50	P7076.0X6.0 ¹⁾	P6076.0X6.0 ¹⁾	P8376.0X6.0 ¹⁾	
8.00	6	6	52	P7078.0X6.0	P6078.0X6.0		
9.60	6	8	54	P7079.6X6.0	P6079.6X6.0	P8379.6X6.0	
12.70	6	11	56	P70712.7X6.0	P60712.7X6.0	P83712.7X6.0	

¹⁾ DCON MS tolerance h6

P809

Rotary Burr – Oval. Brazed above 6.00 mm

P809	P1.1	P1.2	P1.3	P2.1	P2.2	P2.3	P3.1	P3.2	P3.3	P4.1	P4.2	P4.3	M1.1	M1.2	M2.1	M2.2	M2.3
	■	■	■	■	■	■	■	■	■	■	■	■	■	■	■	■	■
	M3.1	M3.2	M3.3	M4.1	M4.2	K1.1	K1.2	K1.3	K2.1	K2.2	K2.3	K3.1	K3.2	K3.3	K4.1	K4.2	K4.3
	■	■	■	■	■	■	■	■	■	■	■	■	■	■	■	■	■
	K4.4	K4.5	K5.1	K5.2	K5.3	N3.1	N3.2	N3.3	S1.1	S1.2	S1.3	S2.1	S2.2	S3.1	S3.2	S4.1	S4.2
	■	■	■	■	■	■	■	■	■	■	■	■	■	■	■	■	■
	H1.1	H2.1	H2.2	H3.1	H3.2	H4.1	H4.2										
	■	■	■	■	■	■	■										

P809

HM

E



DC

DORMER



DORMER























DC	DCON MS h7	APMX	OAL	P809
[mm]	[mm]	[mm]	[mm]	
3.00	3	6	38	P8093.0X3.0 ¹⁾
6.30	3	9.5	42	P8096.3X3.0
6.00	6	10	50	P8096.0X6.0 ¹⁾
8.00	6	15	60	P8098.0X6.0
9.60	6	16	60	P8099.6X6.0
12.70	6	22	67	P80912.7X6.0
16.00	6	25	70	P80916.0X6.0

¹⁾ DCON MS tolerance h6

P709 P609 P509

Rotary Burr – Oval. Brazed.

Rotary Burr – Oval.

P709	P1.1	P1.2	P1.3	P2.1	P2.2	P2.3	P3.1	P3.2	P3.3	P4.1	P4.2	P4.3								
	■	■	■	■	■	■	■	■	■	■	■	■								
P609	M1.1	M1.2	M2.1	M2.2	M2.3	M3.1	M3.2	M3.3	M4.1	M4.2										
	■	■	■	■	■	■	■	■	■	■										
P509	S1.1	S1.2	S1.3	S2.1	S2.2	S3.1	S3.2	S4.1	S4.2											
	■	■	■	■	■	■	■	■	■											
P709	HM	E							ST											
P609	HM	E							VA											
P509	HM	E				AS														



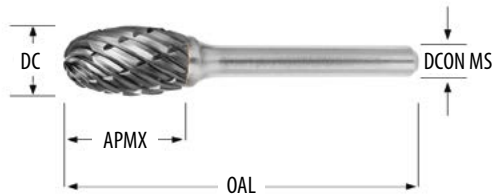

DC	DCON MS h7	APMX	OAL	P709	P609	P509
[mm]	[mm]	[mm]	[mm]			
3.00	3	6	38			P5093.0X3.0 ¹⁾
8.00	6	15	60		P6098.0X6.0	
9.60	6	16	60		P6099.6X6.0	
12.70	6	22	67	P70912.7X6.0	P60912.7X6.0	

¹⁾ DCON MS tolerance h6

P811 P811C

Rotary Burr – Ball Nosed Tree. Brazed above 6.00 mm.

P811 P811C	P1.1	P1.2	P1.3	P2.1	P2.2	P2.3	P3.1	P3.2	P3.3	P4.1	P4.2	P4.3	M1.1	M1.2	M2.1	M2.2	M2.3
	■	■	■	■	■	■	■	■	■	■	■	■	■	■	■	■	■
	M3.1	M3.2	M3.3	M4.1	M4.2	K1.1	K1.2	K1.3	K2.1	K2.2	K2.3	K3.1	K3.2	K3.3	K4.1	K4.2	K4.3
	■	■	■	■	■	■	■	■	■	■	■	■	■	■	■	■	■
	K4.4	K4.5	K5.1	K5.2	K5.3	N3.1	N3.2	N3.3	S1.1	S1.2	S1.3	S2.1	S2.2	S3.1	S3.2	S4.1	S4.2
	■	■	■	■	■	■	■	■	■	■	■	■	■	■	■	■	■
	H1.1	H2.1	H2.2	H3.1	H3.2	H4.1	H4.2										
■	■	■	■	■	■	■											

P811	HM	F					DC		 40 P890
P811C	HM	F			TiAlN		DC		 40 P880





DC	DCON MS h7	APMX	OAL	P811	P811C
[mm]	[mm]	[mm]	[mm]		
3.00	3	14	38	P8113.0X3.0 ¹⁾	P811C3.0X3.0 ¹⁾
6.30	3	12.7	45	P8116.3X3.0	
6.00	6	18	50	P8116.0X6.0 ¹⁾	P811C6.0X6.0 ¹⁾
8.00	6	20	65	P8118.0X6.0	
9.60	6	19	64	P8119.6X6.0	P811C9.6X6.0
12.70	6	25	70	P81112.7X6.0	P811C12.7X6.0
16.00	6	25	70	P81116.0X6.0	

¹⁾ DCON MS tolerance h6

P711

P611



























P841

P511

Rotary Burr – Ball Nosed Tree. Brazed above 6.00 mm.

Rotary Burr – Ball Nosed Tree.

P711	P1.1	P1.2	P1.3	P2.1	P2.2	P2.3	P3.1	P3.2	P3.3	P4.1	P4.2	P4.3						
	■	■	■	■	■	■	■	■	■	■	■	■						
P611	M1.1	M1.2	M2.1	M2.2	M2.3	M3.1	M3.2	M3.3	M4.1	M4.2								
	■	■	■	■	■	■	■	■	■	■								
P841	M1.1	M1.2	M2.1	M2.2	N1.1	N1.2	N1.3	N2.1	N2.2	N2.3	N3.2	N4.1	N4.2	N4.3	S1.1			
	▣	▣	▣	▣	■	■	■	■	■	■	■	■	■	■	■	▣		
P511	S1.1	S1.2	S1.3	S2.1	S2.2	S3.1	S3.2	S4.1	S4.2									
	■	■	■	■	■	■	■	■	■									

P711	HM	F						ST		
P611	HM	F						VA		
P841	HM	F						AL		
P511	HM	F						AS		

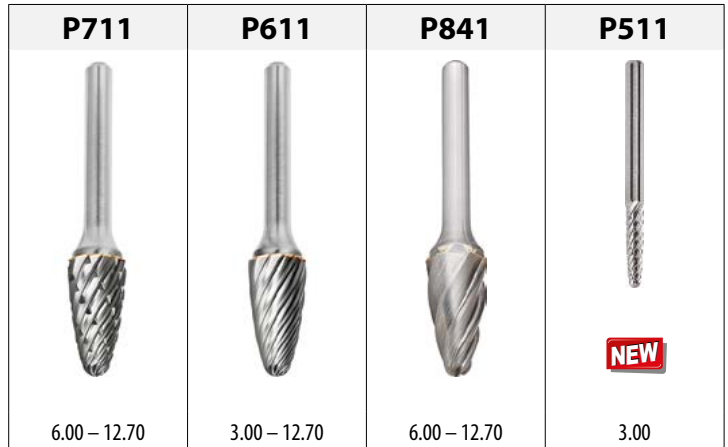

DC	DCON MS h7	APMX	OAL	P711	P611	P841	P511
[mm]	[mm]	[mm]	[mm]				
3.00	3	14	38		P6113.0X3.0 ¹⁾		P5113.0X3.0 ¹⁾
6.30	3	12.7	45		P6116.3X3.0		
6.00	6	18	50	P7116.0X6.0 ¹⁾	P6116.0X6.0 ¹⁾	P8416.0X6.0 ¹⁾	
8.00	6	20	65	P7118.0X6.0	P6118.0X6.0		
9.60	6	19	64	P7119.6X6.0	P6119.6X6.0	P8419.6X6.0	
12.70	6	25	70	P71112.7X6.0	P61112.7X6.0	P84112.7X6.0	

¹⁾ DCON MS tolerance h6

P813 P813C

Rotary Burr – Pointed Tree. Brazed above 6.00 mm.

P813 P813C	P1.1	P1.2	P1.3	P2.1	P2.2	P2.3	P3.1	P3.2	P3.3	P4.1	P4.2	P4.3	M1.1	M1.2	M2.1	M2.2	M2.3
	■	■	■	■	■	■	■	■	■	■	■	■	■	■	■	■	■
	M3.1	M3.2	M3.3	M4.1	M4.2	K1.1	K1.2	K1.3	K2.1	K2.2	K2.3	K3.1	K3.2	K3.3	K4.1	K4.2	K4.3
	■	■	■	■	■	■	■	■	■	■	■	■	■	■	■	■	■
	K4.4	K4.5	K5.1	K5.2	K5.3	N3.1	N3.2	N3.3	S1.1	S1.2	S1.3	S2.1	S2.2	S3.1	S3.2	S4.1	S4.2
	■	■	■	■	■	■	■	■	▣	■	■	■	■	■	■	■	■
	H1.1	H2.1	H2.2	H3.1	H3.2	H4.1	H4.2										

P813	HM	G				DC			40		40
P813C	HM	G			TiAIN	DC			40		



DC	DCON MS h7	APMX	OAL	P813	P813C
[mm]	[mm]	[mm]	[mm]		
3.00	3	14	38	P8133.0X3.0 ¹⁾	P813C3.0X3.0 ¹⁾
6.30	3	12.7	45	P8136.3X3.0	
6.00	6	18	50	P8136.0X6.0 ¹⁾	P813C6.0X6.0 ¹⁾
8.00	6	19	64	P8138.0X6.0	
9.60	6	19	64	P8139.6X6.0	P813C9.6X6.0
12.70	6	25	70	P81312.7X6.0	P813C12.7X6.0
16.00	6	25	70	P81316.0X6.0	

¹⁾ DCON MS tolerance h6

P713 P613 P513

Rotary Burr – Pointed Tree. Brazed above 6.00 mm.

Rotary Burr – Pointed Tree.

P713	P1.1	P1.2	P1.3	P2.1	P2.2	P2.3	P3.1	P3.2	P3.3	P4.1	P4.2	P4.3						
	■	■	■	■	■	■	■	■	■	■	■	■						
P613	M1.1	M1.2	M2.1	M2.2	M2.3	M3.1	M3.2	M3.3	M4.1	M4.2								
	■	■	■	■	■	■	■	■	■	■								
P513	S1.1	S1.2	S1.3	S2.1	S2.2	S3.1	S3.2	S4.1	S4.2									
	■	■	■	■	■	■	■	■	■									

P713	HM	G					ST		
P613	HM	G					VA		
P513	HM	G					AS		

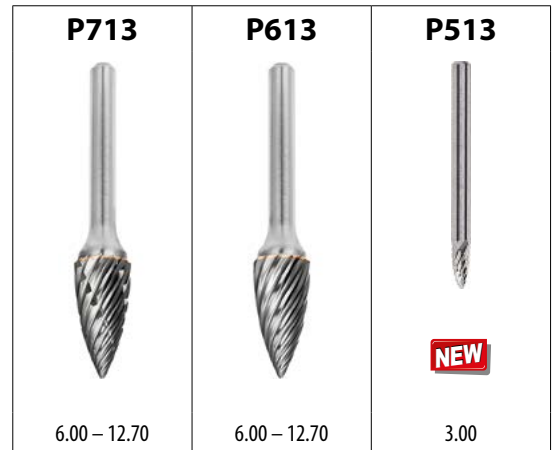
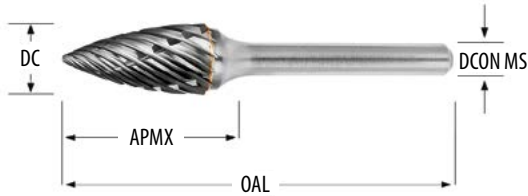

DC [mm]	DCON MS h7 [mm]	APMX [mm]	OAL [mm]	P713	P613	P513
3.00	3	8	38			P5133.0X3.0X8.0 ¹⁾
3.00	3	14	38			P5133.0X3.0X14.0 ¹⁾
6.00	6	18	50	P7136.0X6.0 ¹⁾	P6136.0X6.0 ¹⁾	
8.00	6	19	64	P7138.0X6.0	P6138.0X6.0	
9.60	6	19	64	P7139.6X6.0	P6139.6X6.0	
12.70	6	25	70	P71312.7X6.0	P61312.7X6.0	

¹⁾ DCON MS tolerance h6

P815

Rotary Burr – Flame. Brazed above 6.00 mm.

P815C

Rotary Burr – Flame. Brazed.

P815 P815C	P1.1	P1.2	P1.3	P2.1	P2.2	P2.3	P3.1	P3.2	P3.3	P4.1	P4.2	P4.3	M1.1	M1.2	M2.1	M2.2	M2.3
	■	■	■	■	■	■	■	■	■	■	■	■	■	■	■	■	■
	M3.1	M3.2	M3.3	M4.1	M4.2	K1.1	K1.2	K1.3	K2.1	K2.2	K2.3	K3.1	K3.2	K3.3	K4.1	K4.2	K4.3
	■	■	■	■	■	■	■	■	■	■	■	■	■	■	■	■	■
	K4.4	K4.5	K5.1	K5.2	K5.3	N3.1	N3.2	N3.3	S1.1	S1.2	S1.3	S2.1	S2.2	S3.1	S3.2	S4.1	S4.2
	■	■	■	■	■	■	■	■	□	■	■	■	■	■	■	■	■
	H1.1	H2.1	H2.2	H3.1	H3.2	H4.1	H4.2										
■	■	■	■	■	■	■											

P815	HM	H					DC	
P815C	HM	H					DC	

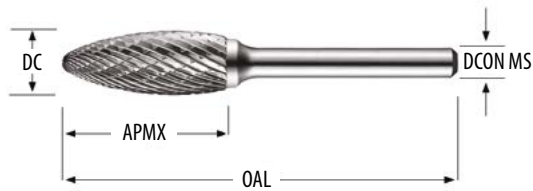

DC	DCON MS h7	APMX	OAL	P815	P815C
[mm]	[mm]	[mm]	[mm]		
3.00	3	6	38	P8153.0X3.0 ¹⁾	
6.00	6	14	50	P8156.0X6.0 ¹⁾	
8.00	6	19	64	P8158.0X6.0	P815C8.0X6.0
9.60	6	19	65	P8159.6X6.0	
12.70	6	32	77	P81512.7X6.0	P815C12.7X6.0
16.00	6	36	81	P81516.0X6.0	

¹⁾ DCON MS tolerance h6

P715 P615 P515

Rotary Burr – Flame. Brazed.





Rotary Burr – Flame.

P715	P1.1	P1.2	P1.3	P2.1	P2.2	P2.3	P3.1	P3.2	P3.3	P4.1	P4.2	P4.3						
	■	■	■	■	■	■	■	■	■	■	■	■						
P615	M1.1	M1.2	M2.1	M2.2	M2.3	M3.1	M3.2	M3.3	M4.1	M4.2								
	■	■	■	■	■	■	■	■	■	■								
P515	S1.1	S1.2	S1.3	S2.1	S2.2	S3.1	S3.2	S4.1	S4.2									
	■	■	■	■	■	■	■	■	■									

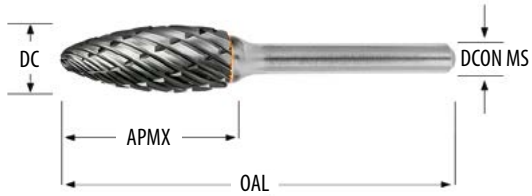
P715	HM	H					ST	
P615	HM	H					VA	
P515	HM	H					AS	 





P715	P615	P515
		
8.00 – 12.70	8.00 – 12.70	3.00
		

DC	DCON MS h7	APMX	OAL	P715	P615	P515
[mm]	[mm]	[mm]	[mm]			
3.00	3	6	38			P5153.0X3.0 ¹⁾
8.00	6	19	64	P7158.0X6.0	P6158.0X6.0	
9.60	6	19	65		P6159.6X6.0	
12.70	6	32	77	P71512.7X6.0	P61512.7X6.0	

¹⁾ DCON MS tolerance h6

P817

Rotary Burr – 60° Countersink. Brazed above 6.00 mm.

P817	P1.1	P1.2	P1.3	P2.1	P2.2	P2.3	P3.1	P3.2	P3.3	P4.1	P4.2	P4.3	M1.1	M1.2	M2.1	M2.2	M2.3
	■	■	■	■	■	■	■	■	■	■	■	■	■	■	■	■	■
	M3.1	M3.2	M3.3	M4.1	M4.2	K1.1	K1.2	K1.3	K2.1	K2.2	K2.3	K3.1	K3.2	K3.3	K4.1	K4.2	K4.3
	■	■	■	■	■	■	■	■	■	■	■	■	■	■	■	■	■
	K4.4	K4.5	K5.1	K5.2	K5.3	N3.1	N3.2	N3.3	S1.1	S1.2	S1.3	S2.1	S2.2	S3.1	S3.2	S4.1	S4.2
	■	■	■	■	■	■	■	■	■	■	■	■	■	■	■	■	■
	H1.1	H2.1	H2.2	H3.1	H3.2	H4.1	H4.2										
■	■	■	■	■	■	■											

P817



DORMER



DC	DCON MS h7	APMX	OAL	P817
[mm]	[mm]	[mm]	[mm]	
3.00	3	2.5	38	P8173.0X3.0 ¹⁾
6.00	6	4	50	P8176.0X6.0 ¹⁾
9.60	6	8	56	P8179.6X6.0
12.70	6	11	59	P81712.7X6.0
16.00	6	14.5	63	P81716.0X6.0

¹⁾ DCON MS tolerance h6

P819

Rotary Burr – 90° Countersink. Brazed above 6.00 mm.

P819	P1.1	P1.2	P1.3	P2.1	P2.2	P2.3	P3.1	P3.2	P3.3	P4.1	P4.2	P4.3	M1.1	M1.2	M2.1	M2.2	M2.3	
	■	■	■	■	■	■	■	■	■	■	■	■	■	■	■	■	■	
	M3.1	M3.2	M3.3	M4.1	M4.2	K1.1	K1.2	K1.3	K2.1	K2.2	K2.3	K3.1	K3.2	K3.3	K4.1	K4.2	K4.3	
	■	■	■	■	■	■	■	■	■	■	■	■	■	■	■	■	■	
	K4.4	K4.5	K5.1	K5.2	K5.3	N3.1	N3.2	N3.3	S1.1	S1.2	S1.3	S2.1	S2.2	S3.1	S3.2	S4.1	S4.2	
	■	■	■	■	■	■	■	■	■	■	■	■	■	■	■	■	■	■
	H1.1	H2.1	H2.2	H3.1	H3.2	H4.1	H4.2											

P819

HM

K



DC

DORMER

DORMER



P819



3.00 – 16.00

DC	DCON MS h7	APMX	OAL	P819
[mm]	[mm]	[mm]	[mm]	
3.00	3	1.5	38	P8193.0X3.0 ¹⁾
6.00	6	3	50	P8196.0X6.0 ¹⁾
9.60	6	4.7	53	P8199.6X6.0
12.70	6	6.3	55	P81912.7X6.0
16.00	6	8	57	P81916.0X6.0

¹⁾ DCON MS tolerance h6

P821 P821C

Rotary Burr – Ball Nosed Cone. Brazed above 6.00 mm.

P821 P821C	P1.1	P1.2	P1.3	P2.1	P2.2	P2.3	P3.1	P3.2	P3.3	P4.1	P4.2	P4.3	M1.1	M1.2	M2.1	M2.2	M2.3
	■	■	■	■	■	■	■	■	■	■	■	■	■	■	■	■	■
	M3.1	M3.2	M3.3	M4.1	M4.2	K1.1	K1.2	K1.3	K2.1	K2.2	K2.3	K3.1	K3.2	K3.3	K4.1	K4.2	K4.3
	■	■	■	■	■	■	■	■	■	■	■	■	■	■	■	■	■
	K4.4	K4.5	K5.1	K5.2	K5.3	N3.1	N3.2	N3.3	S1.1	S1.2	S1.3	S2.1	S2.2	S3.1	S3.2	S4.1	S4.2
	■	■	■	■	■	■	■	■	■	■	■	■	■	■	■	■	■
	H1.1	H2.1	H2.2	H3.1	H3.2	H4.1	H4.2										
	■	■	■	■	■	■	■										

P821	HM	L				DC		
P821C	HM	L			TiAlN	DC		

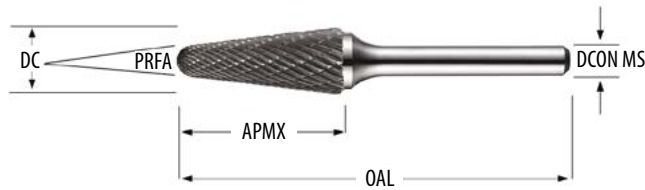

DC	D CON MS h7	APMX	OAL	PRFA	P821	P821C
[mm]	[mm]	[mm]	[mm]	[°]		
3.00	3	14	38	8	P8213.0X3.0¹⁾	P821C3.0X3.0¹⁾
6.00	6	18	50	14	P8216.0X6.0¹⁾	
8.00	6	25.4	70	14	P8218.0X6.0	
9.60	6	30	76	14	P8219.6X6.0	
12.70	6	32	77	14	P82112.7X6.0	P821C12.7X6.0
16.00	6	33	78	14	P82116.0X6.0	

¹⁾ DCON MS tolerance h6

P721

P621



















P842

P521





Rotary Burr – Ball Nosed Cone. Brazed above 6.00 mm.

Rotary Burr – Ball Nosed Cone.

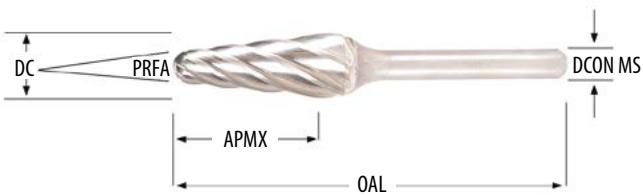
P721	P1.1	P1.2	P1.3	P2.1	P2.2	P2.3	P3.1	P3.2	P3.3	P4.1	P4.2	P4.3						
	■	■	■	■	■	■	■	■	■	■	■	■						
P621	M1.1	M1.2	M2.1	M2.2	M2.3	M3.1	M3.2	M3.3	M4.1	M4.2								
	■	■	■	■	■	■	■	■	■	■								
P842	M1.1	M1.2	M2.1	M2.2	N1.1	N1.2	N1.3	N2.1	N2.2	N2.3	N3.2	N4.1	N4.2	N4.3	S1.1			
	☑	☑	☑	☑	■	■	■	■	■	■	■	■	■	■	■			
P521	S1.1	S1.2	S1.3	S2.1	S2.2	S3.1	S3.2	S4.1	S4.2									
	■	■	■	■	■	■	■	■	■									

P721	HM	L				ST		
P621	HM	L				VA		
P842	HM	L				AL		
P521	HM	L				AS		



P721	P621	P842	P521
			
10.00 – 12.70	8.00 – 12.70	6.00 – 12.70	3.00

DC	DCON MS h7	APMX	OAL	PRFA	P721	P621	P842	P521
[mm]	[mm]	[mm]	[mm]	[°]				
3.00	3	14	38	8°				P5213.0X3.0 ¹⁾
6.00	6	18	50	14°			P8426.0X6.0 ¹⁾	
8.00	6	25.4	70	14°		P6218.0X6.0		
10.00	6	20	65	14°	P72110.0X6.0	P62110.0X6.0		
9.60	6	30	76	14°	P7219.6X6.0		P8429.6X6.0	
12.70	6	32	77	14°	P72112.7X6.0	P62112.7X6.0	P84212.7X6.0	

¹⁾ DCON MS tolerance h6

P823

Rotary Burr – Cone. Brazed above 6.00 mm.

P823	P1.1	P1.2	P1.3	P2.1	P2.2	P2.3	P3.1	P3.2	P3.3	P4.1	P4.2	P4.3	M1.1	M1.2	M2.1	M2.2	M2.3
	■	■	■	■	■	■	■	■	■	■	■	■	■	■	■	■	■
	M3.1	M3.2	M3.3	M4.1	M4.2	K1.1	K1.2	K1.3	K2.1	K2.2	K2.3	K3.1	K3.2	K3.3	K4.1	K4.2	K4.3
	■	■	■	■	■	■	■	■	■	■	■	■	■	■	■	■	■
	K4.4	K4.5	K5.1	K5.2	K5.3	N3.1	N3.2	N3.3	S1.1	S1.2	S1.3	S2.1	S2.2	S3.1	S3.2	S4.1	S4.2
	■	■	■	■	■	■	■	■	■	■	■	■	■	■	■	■	■
	H1.1	H2.1	H2.2	H3.1	H3.2	H4.1	H4.2										
■	■	■	■	■	■	■											

P823



DORMER



DC	DCON MS h7	APMX	OAL	PRFA	P823
[mm]	[mm]	[mm]	[mm]	[°]	
3.00	3	11	38	14	P8233.0X3.0 ¹⁾
6.30	3	12.7	49	22	P8236.3X3.0
6.00	6	20	50	14	P8236.0X6.0 ¹⁾
9.60	6	16	64	28	P8239.6X6.0
12.70	6	22	71	28	P82312.7X6.0
16.00	6	25	71	31	P82316.0X6.0

¹⁾ DCON MS tolerance h6

P523

Rotary Burr – Cone.

P523	S1.1	S1.2	S1.3	S2.1	S2.2	S3.1	S3.2	S4.1	S4.2							
	■	■	■	■	■	■	■	■	■							

P523

HM

M

AS

40
P880

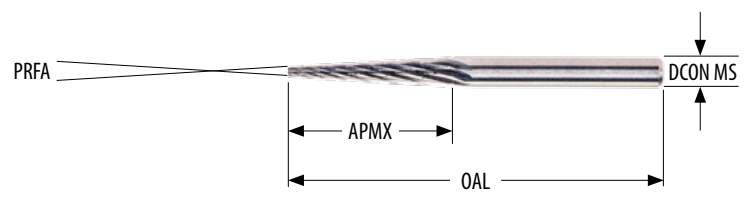

P523

NEW

3.00

DC	DCON MS	APMX	OAL	PRFA	P523
[mm]	[mm]	[mm]	[mm]	[°]	
3.00	3	15	38	7	P5233.0X3.0 ¹⁾

¹⁾ DCON MS tolerance h6

P825

Rotary Burr – Inverted Cone. Brazed above 6.00 mm.

P825	P1.1	P1.2	P1.3	P2.1	P2.2	P2.3	P3.1	P3.2	P3.3	P4.1	P4.2	P4.3	M1.1	M1.2	M2.1	M2.2	M2.3
	■	■	■	■	■	■	■	■	■	■	■	■	■	■	■	■	■
	M3.1	M3.2	M3.3	M4.1	M4.2	K1.1	K1.2	K1.3	K2.1	K2.2	K2.3	K3.1	K3.2	K3.3	K4.1	K4.2	K4.3
	■	■	■	■	■	■	■	■	■	■	■	■	■	■	■	■	■
	K4.4	K4.5	K5.1	K5.2	K5.3	N3.1	N3.2	N3.3	S1.1	S1.2	S1.3	S2.1	S2.2	S3.1	S3.2	S4.1	S4.2
	■	■	■	■	■	■	■	■	■	■	■	■	■	■	■	■	■
	H1.1	H2.1	H2.2	H3.1	H3.2	H4.1	H4.2										
■	■	■	■	■	■	■											

P825



DORMER



DC	DCON MS h7	APMX	OAL	PRFA	P825
[mm]	[mm]	[mm]	[mm]	[°]	
3.00	3	4	38	10°	P8253.0X3.0 ¹⁾
6.30	3	6	39	12°	P8256.3X3.0
6.00	6	8	50	10°	P8256.0X6.0 ¹⁾
9.60	6	9.5	55	16°	P8259.6X6.0
12.70	6	12.7	58	28°	P82512.7X6.0
16.00	6	19	64	18°	P82516.0X6.0

¹⁾ DCON MS tolerance h6

P843

Diamond Cut Router – 135° Drill Point.

P843	N4.1	N4.2	N4.3														
	■	■	■														

P843

HM











135°

GRP



 DORMER

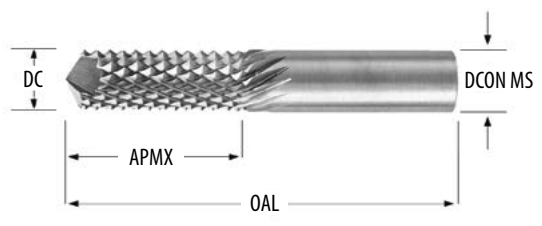

DC	DCON MS h7	APMX	OAL	P843
[mm]	[mm]	[mm]	[mm]	
3.00	3	13	45	P8433.0X3.0
6.00	6	19	63	P8436.0X6.0
8.00	8	25	63	P8438.0X8.0

P844

Diamond Cut Router – End Mill Cut.

P844	N4.1	N4.2	N4.3															
	■	■	■															

P844

HM

180°

GRP

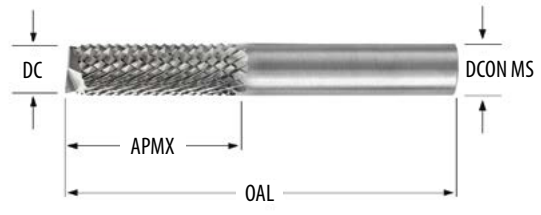

DC	DCON MS h7	APMX	OAL	P844
[mm]	[mm]	[mm]	[mm]	
3.00	3	13	45	P8443.0X3.0
6.00	6	19	63	P8446.0X6.0
8.00	8	25	63	P8448.0X8.0

P100

Rotary Burr – Cylinder with End-Cut only for bolt removal.

P100	P1.1	P1.2	P1.3	P2.1	P2.2	P2.3	P3.1	P3.2	P3.3	P4.1	P4.2	P4.3	M1.1	M1.2	M2.1	M2.2	M2.3
	■	■	■	■	■	■	■	■	■	■	■	■	■	■	■	■	■
	M3.1	M3.2	M3.3														

P100

HM



BR



DORMER

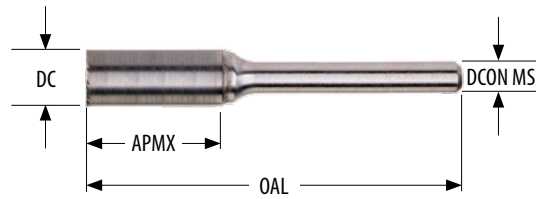

P100



NEW

4.90 – 10.70

DC [mm]	DCON MS [mm]	APMX [mm]	OAL [mm]		P100
4.90	6	20	50	1/4-20, 24, 28, M6	P1004.9
6.40	6	5	50	5/16-18, 24, 32, M8	P1006.4
7.80	6	19	65	3/8-16, 24, M10	P1007.8
9.30	6	19	65	7/16-14, 20, M12	P1009.3
10.70	6	25	70	1/2-13, 20, M14	P10010.7

P101

Rotary Burr – Countersink 150° for bolt removal.

P101	P1.1	P1.2	P1.3	P2.1	P2.2	P2.3	P3.1	P3.2	P3.3	P4.1	P4.2	P4.3	M1.1	M1.2	M2.1	M2.2	M2.3
	■	■	■	■	■	■	■	■	■	■	■	■	■	■	■	■	■
	M3.1	M3.2	M3.3														

P101        



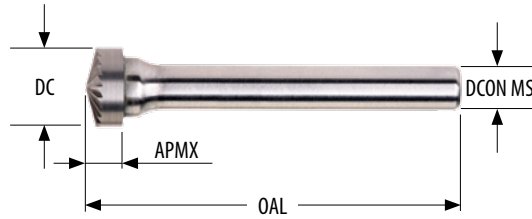

P101



NEW

4.90 – 10.70

DC	DCON MS	APMX	OAL		P101
[mm]	[mm]	[mm]	[mm]		
4.90	6	20	50	1/4-20, 24, 28, M6	P1014.9
6.40	6	5	50	5/16-18, 24, 32, M8	P1016.4
7.80	6	5	50	3/8-16, 24, M10	P1017.8
9.30	6	5	50	7/16-14, 20, M12	P1019.3
10.70	6	5	50	1/2-13, 20, M14	P10110.7

P880

Rotary Burr Set. A = Styles in Set, B = No. in Set, C = Diameters in Set.



P880



Set

Set number	A	B	C	P880
01	P803 + P805 + P807 + P809 + P813	5	P8039.6×6.0, P8059.6×6.0, P8079.6×6.0, P8099.6×6.0, P8139.6×6.0	P88001
02	P803C + P805C + P807C + P811C + P813C	5	P803C9.6×6.0, P805C9.6×6.0, P807C9.6×6.0, P811C9.6×6.0, P813C9.6×6.0	P88002
03	P601 + P605 + P607 + P611 + P621	5	P6019.6×6.0, P6059.6×6.0, P6079.6×6.0, P6119.6×6.0, P62110.0×6.0	P88003
04	P703 + P705 + P707 + P711 + P721	5	P7039.6×6.0, P7059.6×6.0, P7079.6×6.0, P7119.6×6.0, P72110.0×6.0	P88004
06	P501 + P505 + P507 + P509 + P511 + P513 + P515 + P521 + P523	10	P5013.0×3.0, P5053.0×3.0, P5073.0×3.0, P5093.0×3.0, P5113.0×3.0, P5133.0×3.0×8.0, P5133.0×3.0×14.0, P5153.0×3.0, P5213.0×3.0, P5233.0×3.0	P88006

P890

Rotary Burr Dispenser. A = Styles in Set, B = No. in Set, C = Diameters in Set.





































P890



Box

Set number	A	B	C	P890
01	P803 + P805 + P811 + P813 + P821	40	P803(6.0×6.0, 8.0×6.0, 9.6×6.0, 12.7×6.0) × 2, P805(6.0×6.0, 8.0×6.0, 9.6×6.0, 12.7×6.0) × 2, P811(6.0×6.0, 8.0×6.0, 9.6×6.0, 12.7×6.0) × 2, P813(6.0×6.0, 8.0×6.0, 9.6×6.0, 12.7×6.0) × 2, P821(6.0×6.0, 8.0×6.0, 9.6×6.0, 12.7×6.0) × 2	P89001

ICON DESCRIPTIONS

Material	 Carbide				
Coating	 Bright	 Titanium Aluminium Nitride			
Countersink	 60°	 90°	 150°	 135°	 180°
Application	 Cylinder without endcut	 Cylinder with endcut	 Ball Nosed Cylinder	 Ball	 Oval
	 Ball nosed tree	 Pointed Tree	 Flame	 60° Countersink	 90° Countersink
	 Ball nosed cone	 Cone	 Inverted cone	 Fibreglass routing	
	 Bolt removal preparation – Operation 1	 Bolt removal preparation – Operation 2			
Type	 High Metal Removal Rate in Steels	 High Metal Removal Rate in Stainless Steels	 Aluminium Cut for non-ferrous materials including plastics	 Fibreglass and Composites	 Double Cut for General purpose use
	 Bolt removal preparation	 High quality finishing of small Superalloy components			
End Cut	 Standard	 Drill Point	 End Mill		

WARNING

These recommendations are for standard length Burrs with 13 mm maximum overhang, when exceeding the maximum overhang of 13 mm it is generally recommended to use much lower safety speeds. Don't run the burr above the maximum speed, this can cause premature wear. Don't run the burr too slowly, this can cause chipping.

Don't apply more cutting depth than 1/3 of the diameter, don't encapsulate. For brazed rotary burrs: don't allow the burr to become too hot, this may cause the braze to soften and cause the head to become detached from the shank.



Personal protective equipment must be worn at all times!

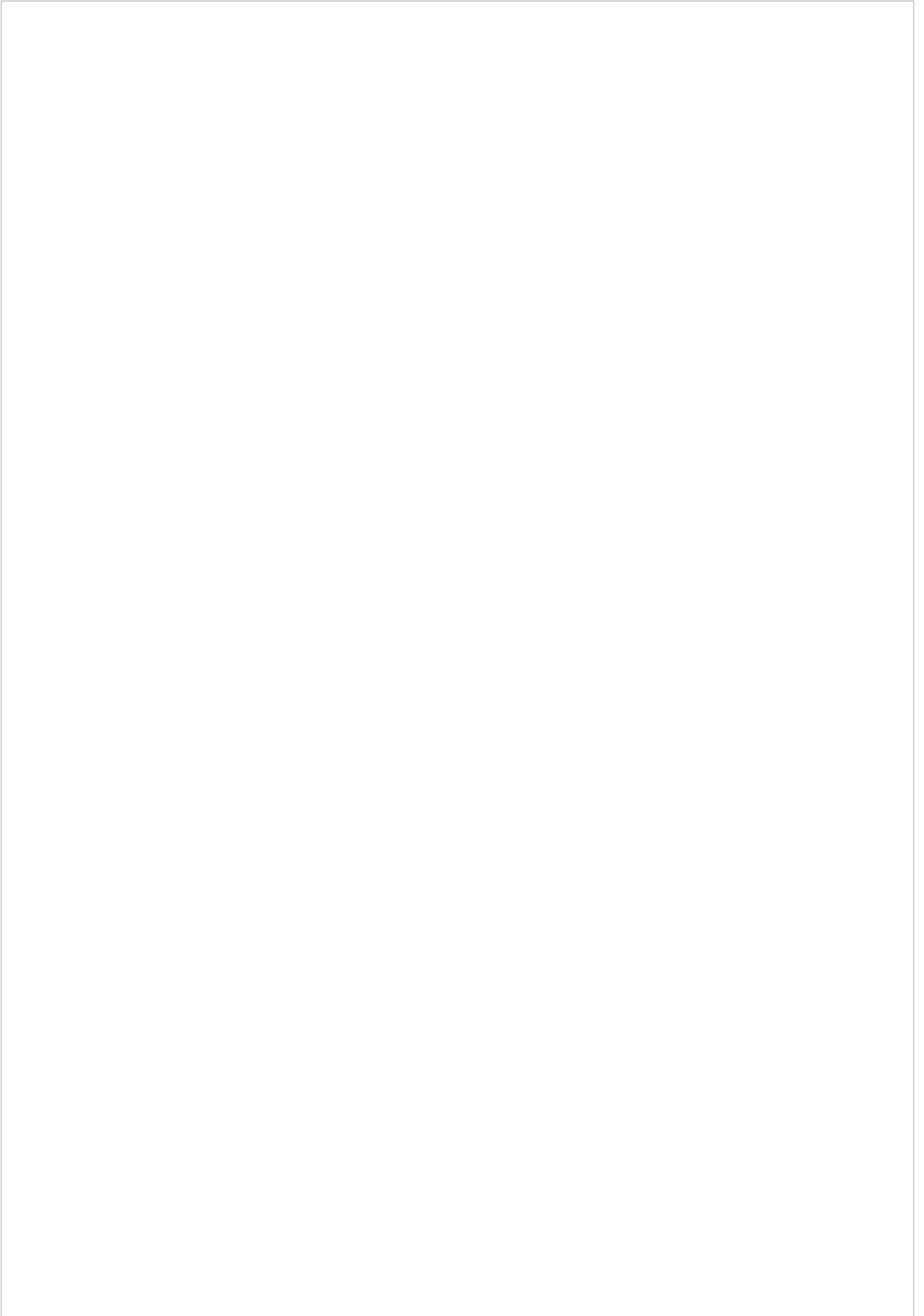

SIMPLY RELIABLE

As a professional you can judge the quality of work by just looking at the chip. Our chip is a clean and uncomplicated shape that in itself tells a story. It is a clear and consistent signal and that's why we use it as a symbol for being **Simply Reliable**.

Argentina

T: 54 (11) 6777-6777
F: 54 (11) 4441-4467
info.ar@dormerpramet.com

Austria

T: +31 10 2080 240
info.at@dormerpramet.com

Belgium & Luxembourg

T: +32 3 440 59 01
info.be@dormerpramet.com

Brazil

T: +55 11 5660 3000
info.br@dormerpramet.com

Canada

T: (888) 336 7637
En Français: (888) 368 8457
F: (905) 542 7000
cs.canada@dormerpramet.com

China

T: +86 21 2416 0508
info.cn@dormerpramet.com

Croatia

T: +385 98 407 489
info.hr@dormerpramet.com

Czech Republic

T: +420 583 381 111
F: +420 583 215 401
info.cz@dormerpramet.com

Denmark

T: 808 82106
info.se@dormerpramet.com

Finland

T: 0205 44 7003
info.fi@dormerpramet.com

France

T: +33 (0)2 47 62 57 01
F: +33 (0)2 47 62 52 00
info.fr@dormerpramet.com

Germany

T: +49 9131 933 08 70
F: +49 9131 933 08 742
info.de@dormerpramet.com

Hungary

T: +36-96 / 522-846
F: +36-96 / 522-847
info.hu@dormerpramet.com

India

T: +91 11 4601 5686
info.in@dormerpramet.com

Italy

T: +39 02 30 70 51
info.it@dormerpramet.com

Kazakhstan

T: +7 771 305 11 45
info.kz@dormerpramet.com

Mexico

T: +52 (555) 7293981
F: +52 (555) 7293981
cs.mexico@dormerpramet.com

Netherlands

T: +31 10 2080 240
info.nl@dormerpramet.com

Norway

T: 800 10 113
info.se@dormerpramet.com

Poland

T: +48 32 78-15-890
F: +48 32 78-60-406
info.pl@dormerpramet.com

Portugal

T: +351 21 424 54 21
info.pt@dormerpramet.com

Romania

T: +4(0)730 015 885
info.ro@dormerpramet.com

Russia

T: +7 (495) 775 10 28
Ф: +7 (499) 763 38 90
info.ru@dormerpramet.com

Slovakia

T: +421 (41) 764 54 60
F: +421 (41) 763 74 49
info.sk@dormerpramet.com

Slovenia

T: +385 98 407 489
info.si@dormerpramet.com

Spain

T: +34 935717722
info.es@dormerpramet.com

Sweden

responsible for Iceland
T: +46 35 16 52 96
info.se@dormerpramet.com

Switzerland

T: +31 10 2080 240
info.ch@dormerpramet.com

Turkey

T: +90 533 212 45 47
info.tr@dormerpramet.com

Ukraine

T: +38 056 736 30 21
F: +38 067 220 97 48
info.ua@dormerpramet.com

United Kingdom

responsible for Ireland
T: 0870 850 4466
F: 0870 850 8866
info.uk@dormerpramet.com

United States of America

T: (800) 877-3745
F: (847) 783-5760
cs@dormerpramet.com

Other countries

South America

T: +55 11 5660 3000
F: +55 11 5667 5883
info.br@dormerpramet.com

Adria

T: +420 583 381 527
F: +420 583 381 401
info.rcee@dormerpramet.com

Rest of the World

Dormer Pramet International UK
T: +44 1246 571338
F: +44 1246 571339
info.int@dormerpramet.com

Dormer Pramet International CZ
T: +420 583 381 520
F: +420 583 215 401
info.int.cz@dormerpramet.com