

**Armstrong**Flooring™

**Flooring and Installation  
Accessories**

Extruded Vinyl Profiles

# Flooring and Installation Accessories

## Extruded Vinyl Profiles

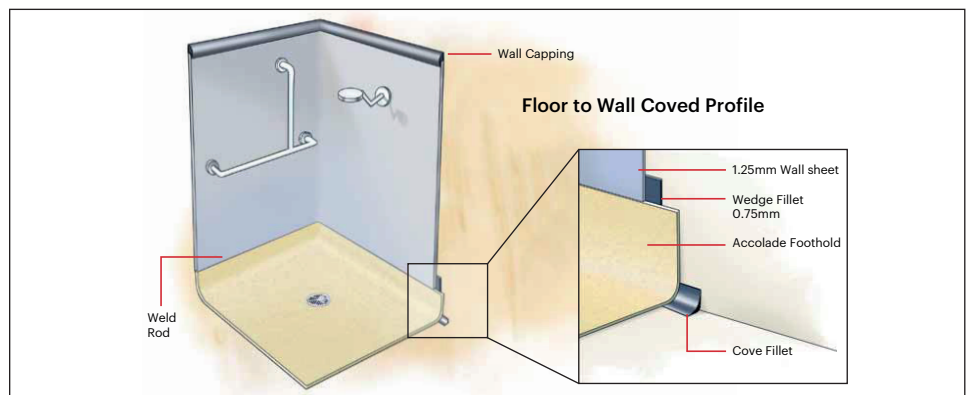
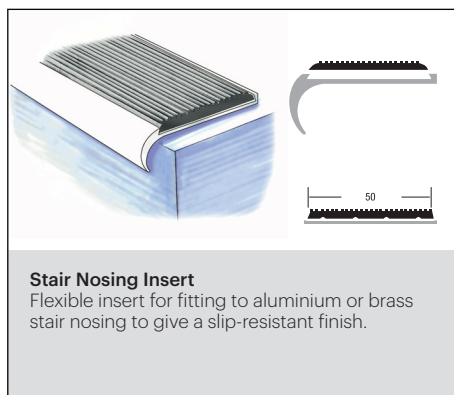
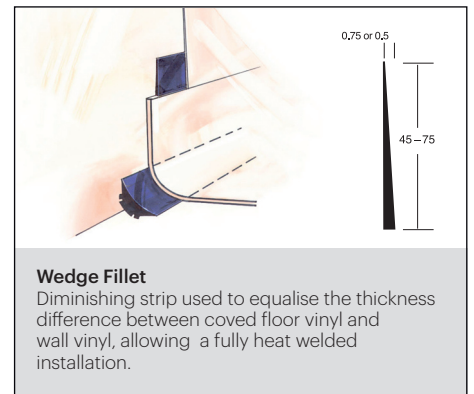
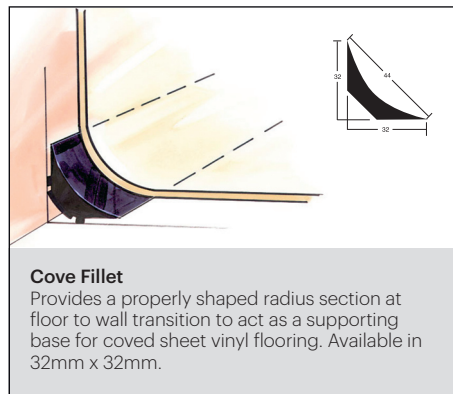
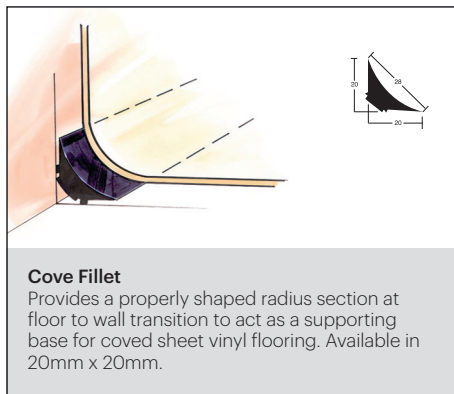
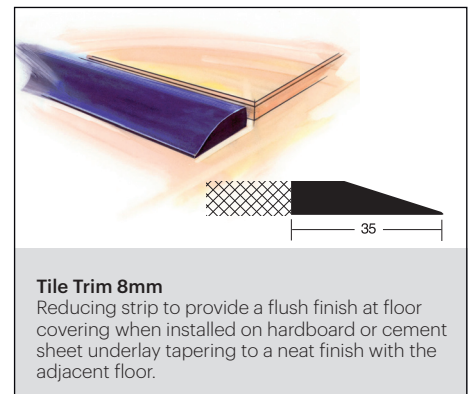
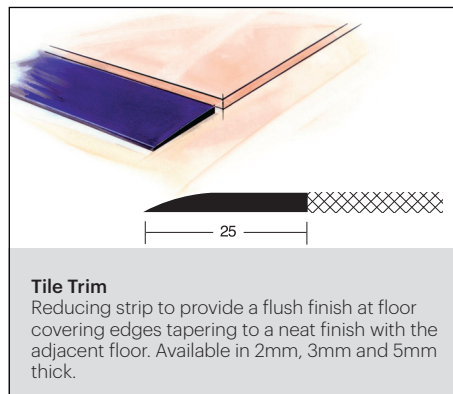
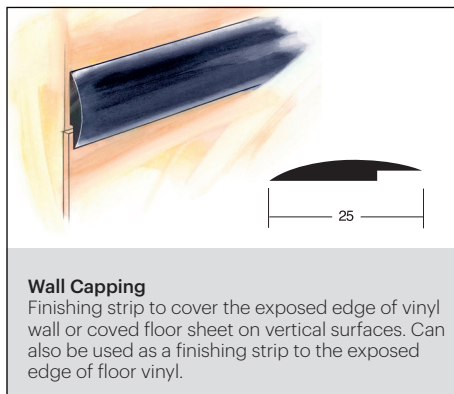
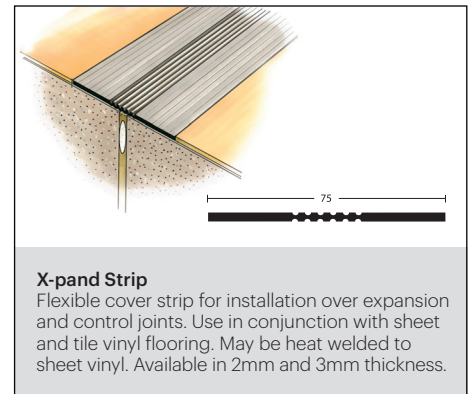
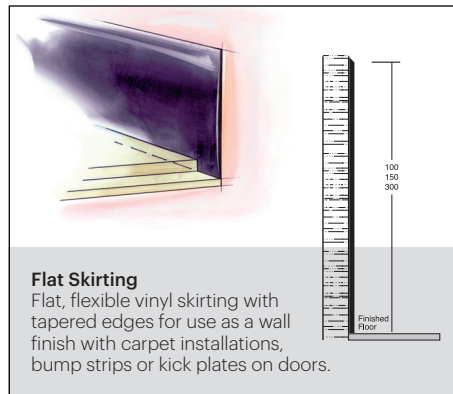
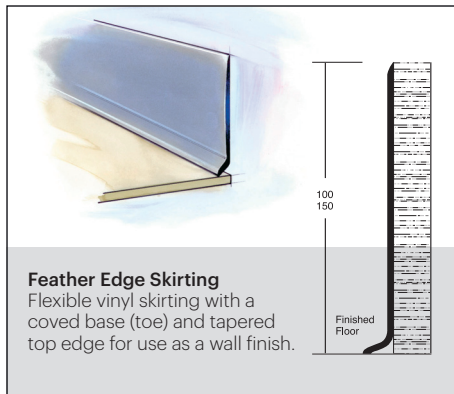

**Please note:** Recommendations are for guidance only. Refer to relevant local, state, and federal construction codes and standards for requirements. Variations may occur between photographic images, samples and batches in terms of colour, shade, pattern or similar. All measurements are nominal. Please check website for most current lines.

# Flooring and Installation Accessories

## Extruded Vinyl Profiles



BLACK



DENIM



GREY

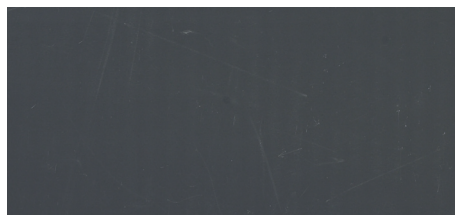

MIDNIGHT



LATTE



WHITE





FLINT



DUNE

PROFILE	Size	Ctn Qty	Black	White	Dune	Grey	Latte	Flint	Midnight	Denim
Skirting										
Feathered Edge	100mm	3 x 15m								
	150mm	2 x 15m								
Flat	100mm	3 x 30m								
	150mm	2 x 30m								
	300mm	1 x 30m								
Wall Capping	25mm	8 x 15m								
Tile Trim	2mm, 3mm, 5mm	8 x 15m								
	8mm	6 x 15m								
X-pand Strip	2mm	4 x 15m								
	3mm	4 x 15m								
Stair Nosing Insert	50mm	4 x 26m								
Cove Fillet	20mm x 20mm	7 x 15m								
	32mm x 32mm	5 x 15m								
Wedge Fillet	0.75mm	8 x 25m								
	0.50mm	5 x 40m								

-  • Standard stocked item.
-  • Additional colours available – Minimum carton quantities per colour/profile apply (Contact Customer Services for details).
-  • Not available.

**Armstrong**Flooring™

Proudly Manufacturing in Australia Since 1969

Armstrong Skirting – The industry standard in flooring accessories.

---

Armstrong Flooring™  
29 – 39 Mills Road Braeside 3195  
Victoria Australia  
1800 632 624  
[www.armstrongflooring.au](http://www.armstrongflooring.au)



Armstrong Flooring and the Armstrong Flooring logo are used under license from AWI Licensing, LLC

February 2024