

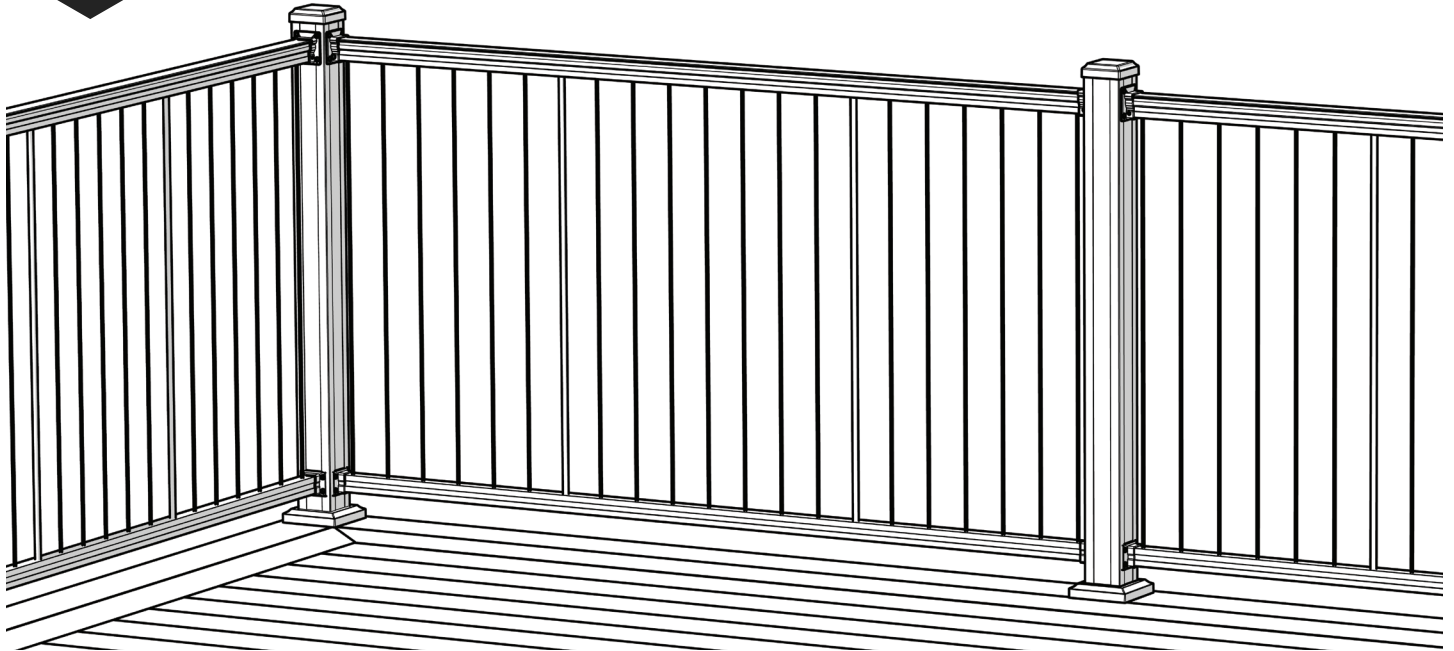

KEY-LINK™
FENCING & RAILING

Vertical CABLE INFILL



Recommended Tools

- Safety Glasses
- Tape Measure & Pencil
- Level
- Drill & Bits ($\frac{1}{4}$ ", $\frac{3}{16}$ ", $1\frac{1}{32}$ ")
- Hammer Drill (if concrete)
- Circular Saw w/ Fine-Tooth Aluminum Cutting Blade
- Rubber Mallet
- Socket Wrench ($\frac{7}{16}$ " socket)

● Available from Key-Link

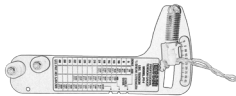

● Tension Gauge



Air Ratchet
(optional)

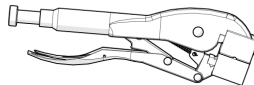

● Cable Vise Grip

What's Included

- Top & Bottom Rail w/ Cables attached
- Mounting Brackets & Screws
(Posts, Caps, & Trim packaged separate)
- Stainless Steel Support Rods
- Flange Nuts
- Snap on Section Support
(For sections over 6')

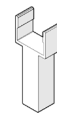

Snap on Section Support



Top Level Bracket



Flange Nuts



Bottom Level Bracket



#12 Flat-Head Screws



#10 Pan-Head Screws

Tip: Wear clean, new gloves when handling stainless steel parts to prevent corrosion from oil and dirt.

- These directions are only a guide and may not address every situation.
- Always wear proper safety equipment while assembling and installing.
- The installer should obtain all required building permits and follow all installation procedures in accordance with applicable building code requirements.
- Key-Link Fencing and Railing Inc. shall not be held liable for improper or unsafe installations.
- Applying paint, other than Key-Link's touch up paint, will void your warranty.
- To ensure proper coverage by our warranty please visit our website and complete the warranty form and mail to: Key-Link Fencing & Railing, Inc., 150 Orlan Road, New Holland, PA 17557



WARNING: This product can expose you to chemicals including Quartz (crystalline silica), which is known to the State of California to cause cancer, and Hexavalent Chromium, which is known to the State of California to cause birth defects or other reproductive harm. For more information go to www.P65Warnings.ca.gov.

1 Install Railing Post & Post Trim

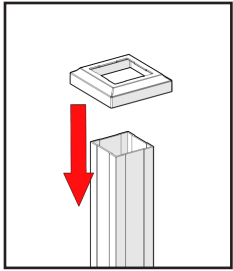

Placing trim

Space Posts according to *application and Top Rail length. Place leveling plate (*highlighted*) between Post and mounting surface.

Attach to structural surface using bolts or lags (*not included*). Partially Tighten prior to levelling. Using 3/16" Allen wrench, turn set screws to level Post. Then fully tighten structural screws.

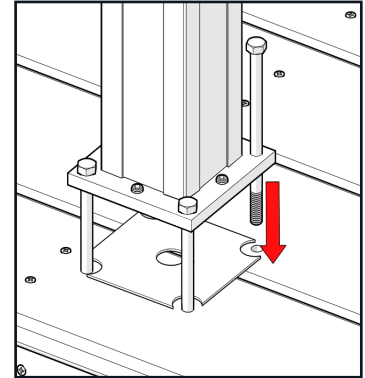

*Check your local building codes to determine structural mounting requirements for Post.

2 Prep Rail & Cable Section

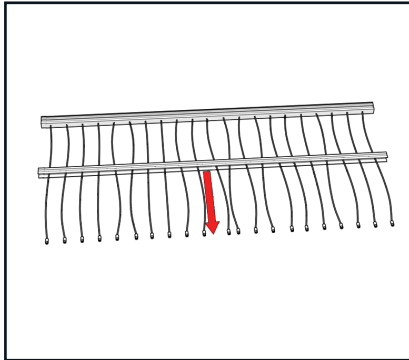

Unwrap cables and lay section flat (on a non-abrasive surface). Then spread Rails tightly to each end.

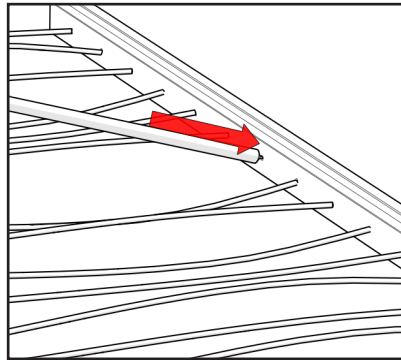

View the chart to determine the rods' positions, cut and remove unnecessary cables, then insert rods into empty holes.

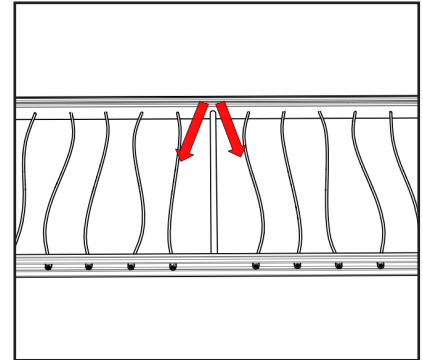

Place all Flange Nuts, then finger tighten the Nuts of only the cables adjacent to each Support Rod.

Note: Do not tighten any other cables.

# of Support Rods	Length of Section
1	19" to 38"
2	39" to 57"
3	58" to 76"
4	77" to 95"

3 Cut to Length

Measure between Posts subtracting 1/4" from total length, and if necessary cut Rails to proper length by cutting an equal amount from each end. Be sure to leave the proper number of Spacer Bars remaining by referencing the chart below.

Note: There are Cable Crimps and Flange Nuts attached to ends of each cable inside the Top and Bottom Rail. Do not cut through cable hardware. If cut is on the inside of the cable, remove unnecessary hardware (*i.e. wire cutters*) prior to cutting.

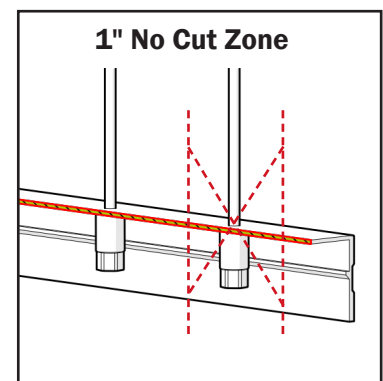

Cut Away View

4 Place Rail and Cable Section

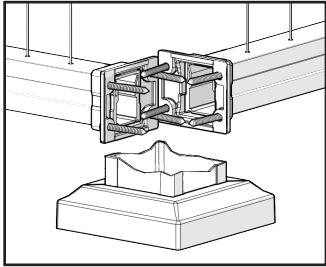

2 1/2" Post: 1/8" offset shown

Slide the Brackets over each Rail.

Using two 2 1/2" tall blocks; lower the Section to be installed onto the blocks.

Recommended: If using 2 1/2" Post; offset one section at a corner, by raising it an additional 1/8" (helps avoid Mounting Bracket screw interference).

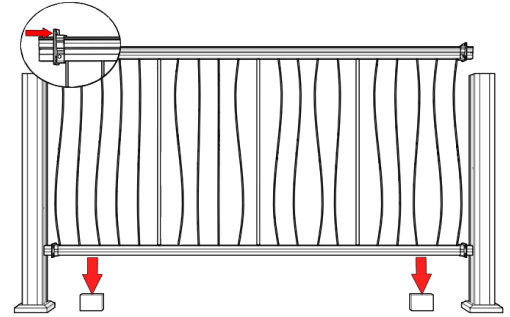

5 Attach Top & Bottom Rail

Ensure Top Rail is correct height from deck surface (check both sides).

Put the Rail in place, and slide the self-centering Bracket against the Post.

Fasten Bracket to Post using #12 flat-head screws, and secure Bracket to Rail using #10 pan-head screws.

Repeat these steps for Bottom Rail (ensure rail is 2 1/2" above deck surface)

Install Post Cap using soft/rubber mallet.

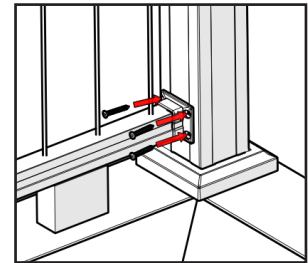
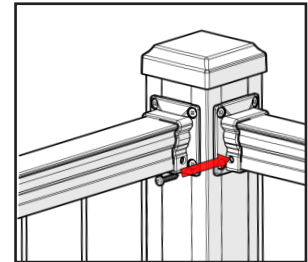
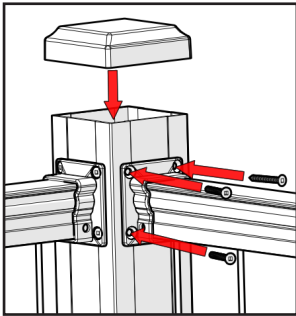

6 Tension Cables

To start; ***tension** the cable closest to the Post (refer to diagram below). Then move to the cable on the opposite end closest to the Post.

Now, still working from side to side; ***tension** the cable immediately next to the stabilizer. Then move to the opposite side of the section, and do the same.

Repeat this process, and move gradually inward until you reach the center.

***tension:** Use a 7/16" socket while preventing the Cable from rotating, by clamping it (Cable Vice Grip recommended) as close to the Bottom Rail as possible.

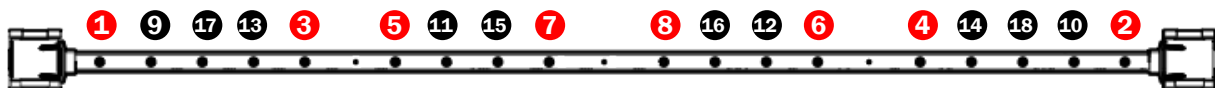
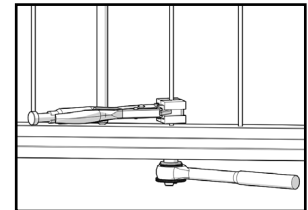
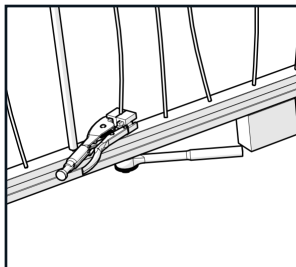

= 100lbs. of tension (#9 on a [Keylink Tension Gauge](#))

= 75lbs. of tension (#7 on a [Keylink Tension Gauge](#))

Installer Tip: Cut two blocks (*highlighted*) to fill the distance between the Rails, and place them on either end of a section prior to installation. This helps keep the section rigid during installation.

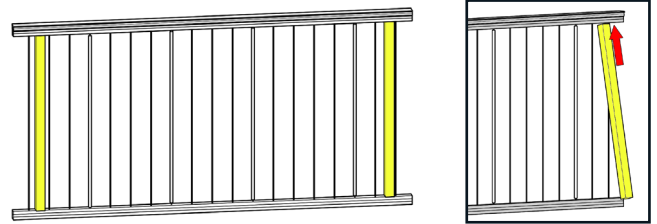

7 Stair Rail Installation

Measure from inside edge between Posts subtracting 1/4" from total length, and if necessary cut Rail to proper length by cutting an equal amount from each end. Do not cut through Cable Hardware (refer to pg. 2 Step 3)

To ensure Rails align properly; cut upper and lower ends of Top and Bottom Rails separately, and at opposite angles.

Tip: Hold Stair Section at final angle while cutting. Be sure to keep cable hardware clear of blades.

(Standard stair angle is 34°)

! Cutting Tip
Be sure to use a **fine-tooth blade approved for cutting aluminum** and rest rails on a piece of **non-abrasive material** to protect from scratches.

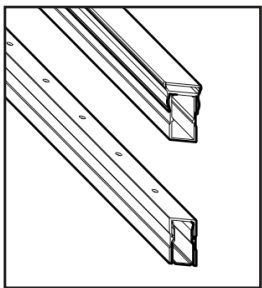
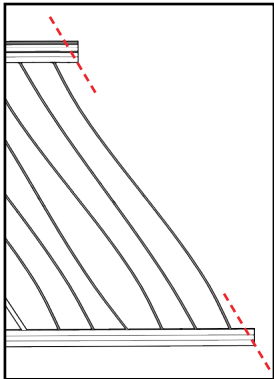
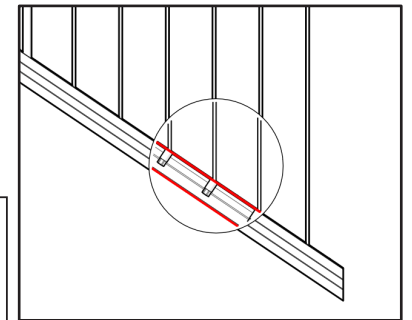
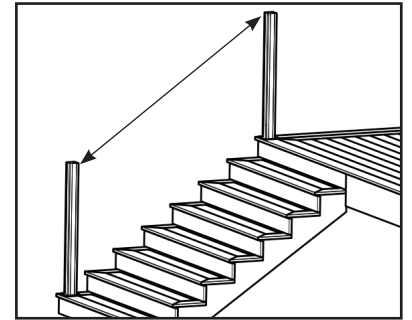
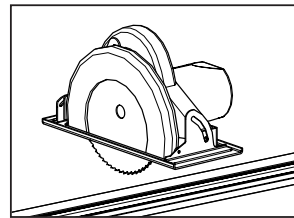

! When doing stair sections, mount them as shown below:

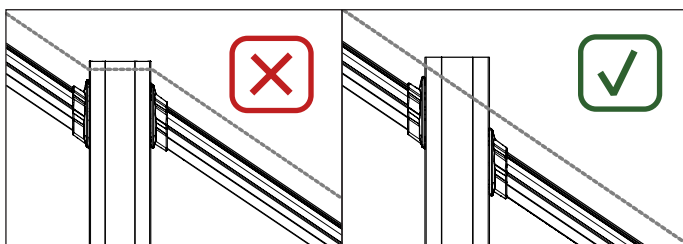

Note: Always check local building codes to ensure compliance as there are mandates regarding the size opening of each section.

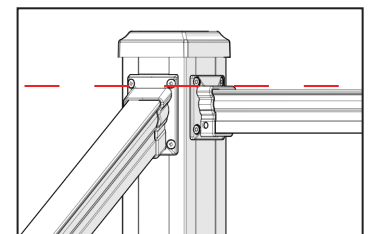

Ensure that the stairs' Top Rail doesn't exceed the level height of the opposite Rail.



260 Jalyn Drive • New Holland, PA 17557

KeyLinkOnline.com