

Atmosphere

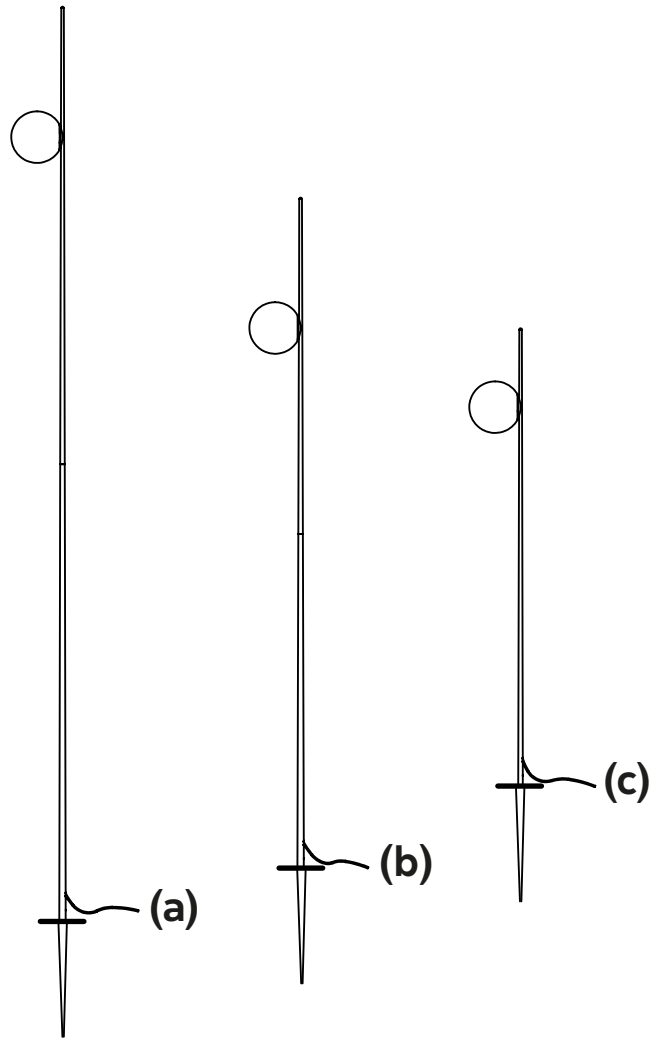

KARMAN

HP302 DN EXT (a)
HP302 EN EXT (b)
HP302 FN EXT (c)

1 x max 18W LED

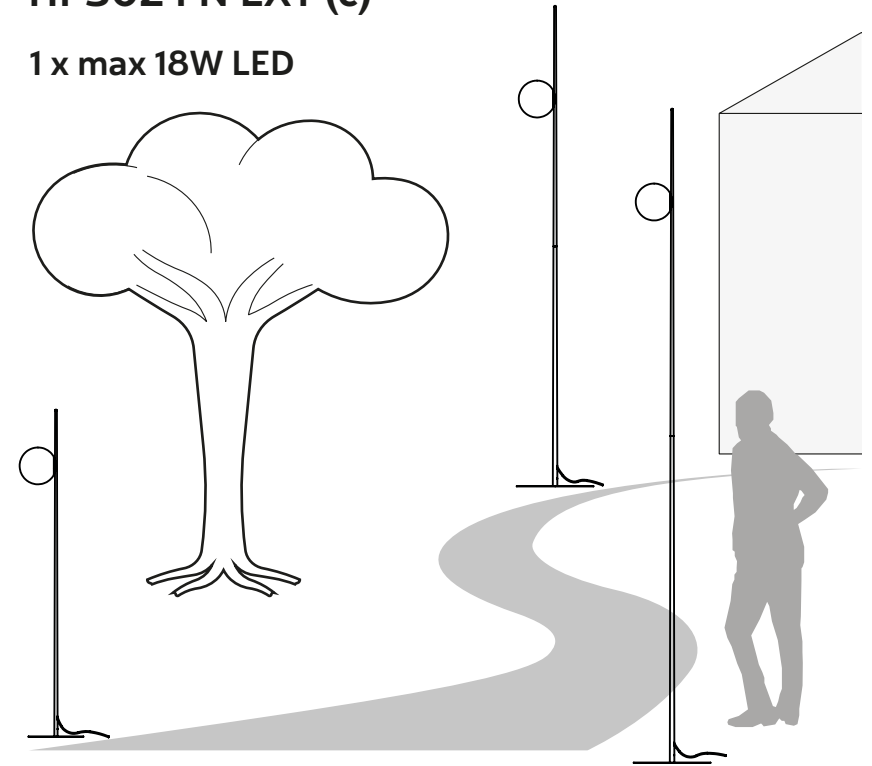

Karman srl

Via A. Grandi, San Martino del piano, 61034 Fossombrone (PU), Italy
p.iva 02175640412 tel +39 0721 71 5042 r.a fax +39 0721 716640 - www.karmanitalia.it

IP55

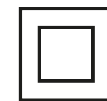

CE

C - 01

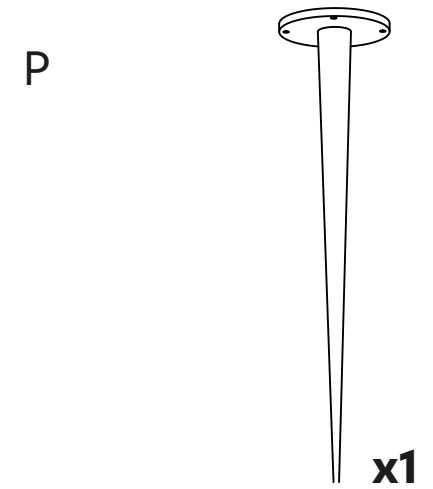
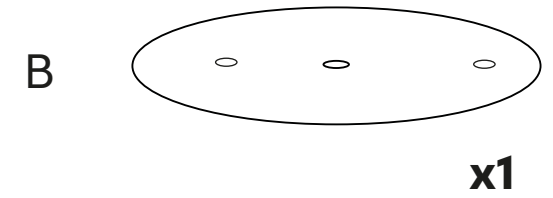
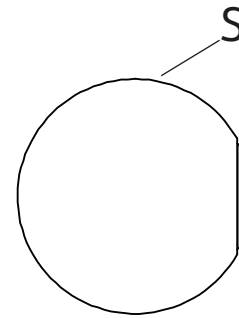
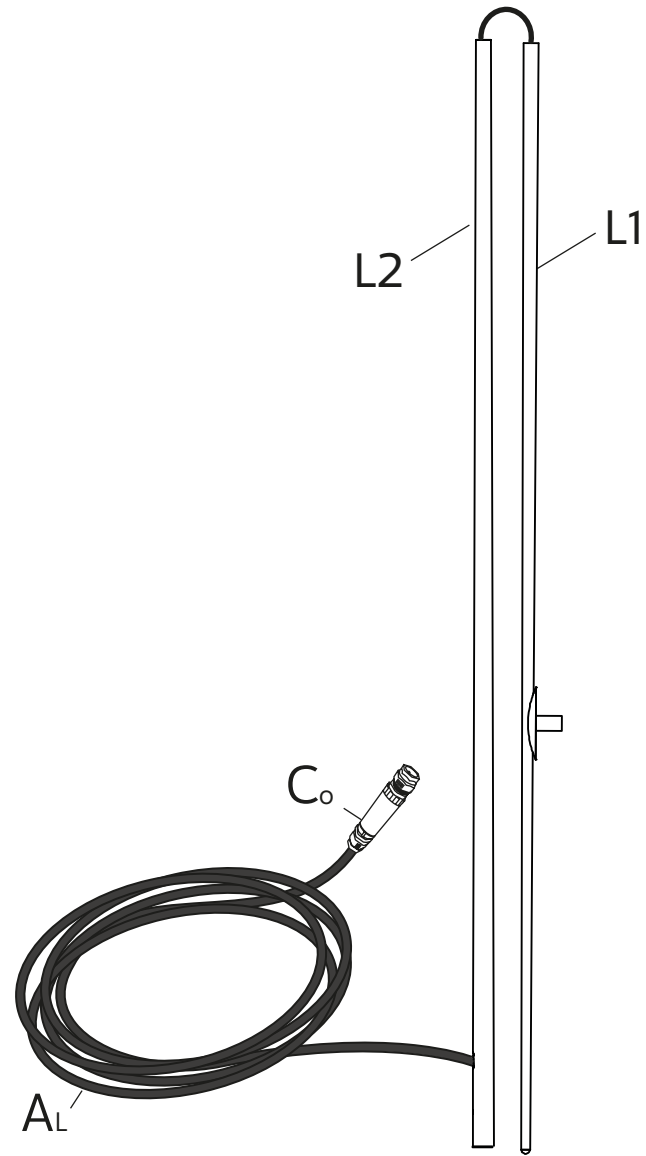

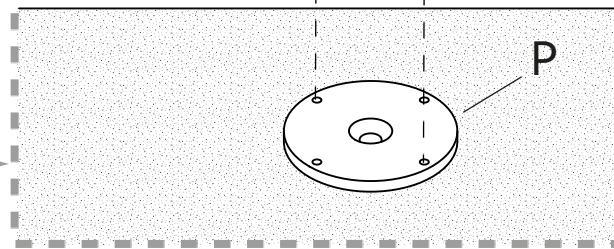
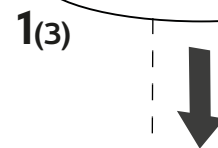
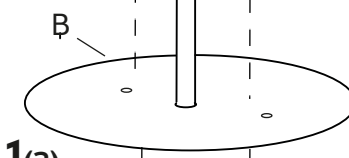
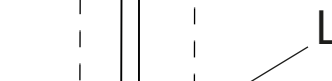
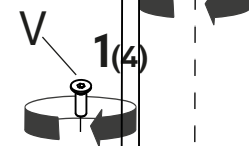
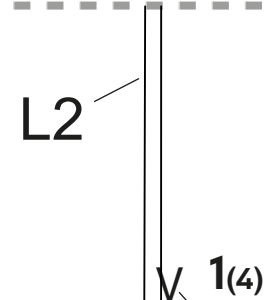
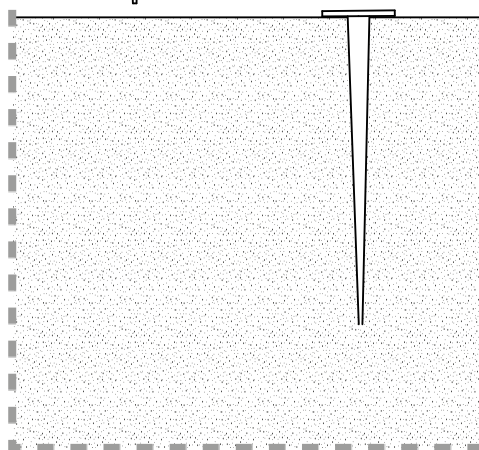
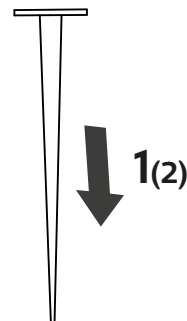
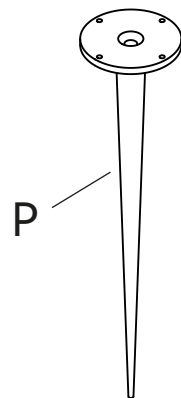
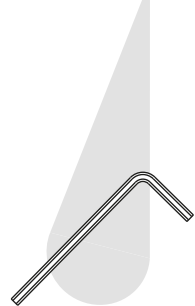
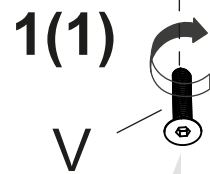
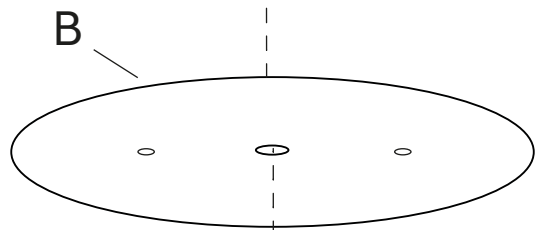
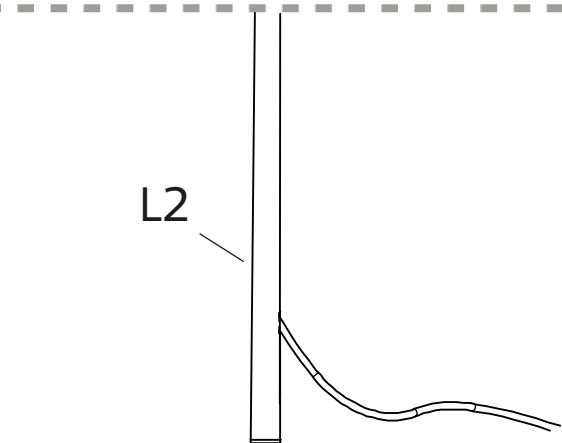

1

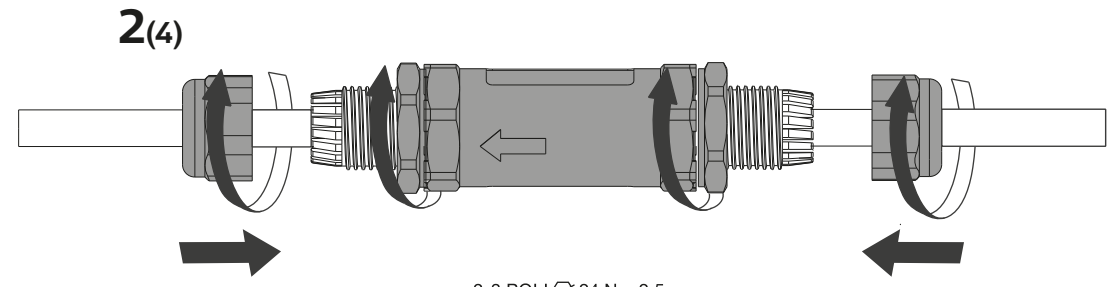
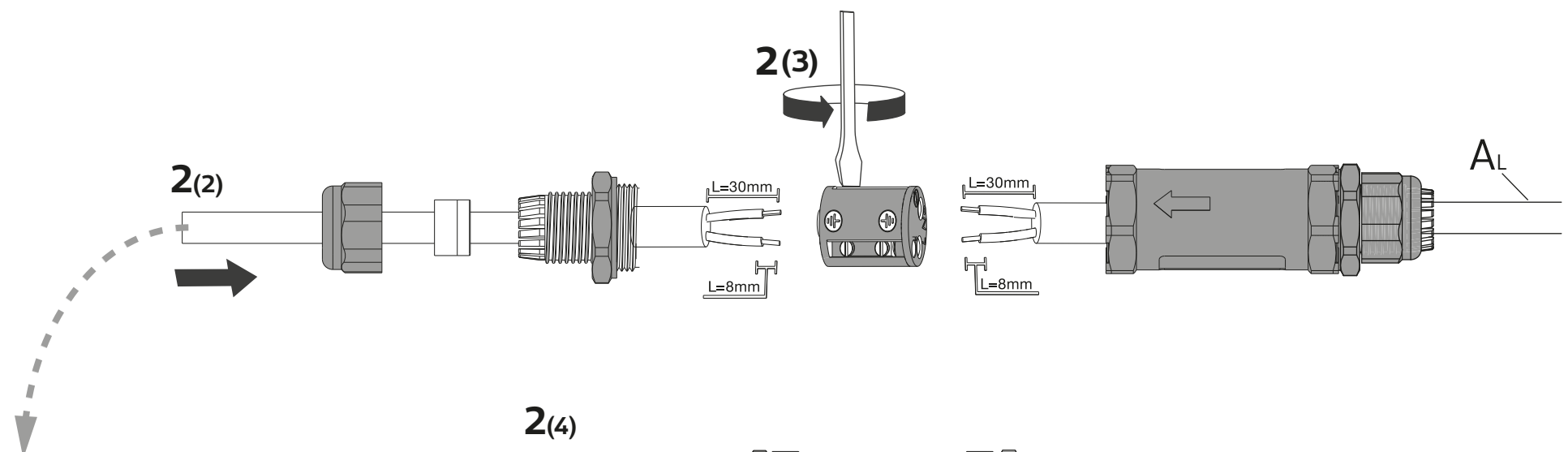
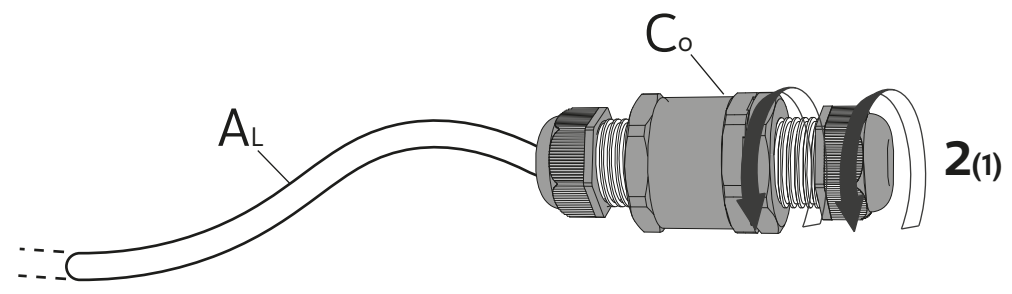
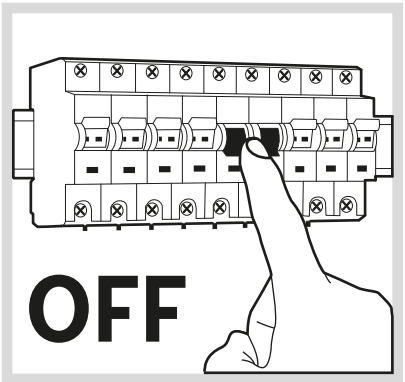

2-3 POLI \varnothing 24 Nm 2.5

