

AMARCORD table lamp

Matteo Ugolini design

year 2016

DATA SHEET - CT121 1B INT

BASE "A"

material	concrete	
colour	white	

DIFFUSER "B"

material	glass	
colour	transparent	

ELECTRICAL CABLE

colour	transparent	
--------	-------------	---

ELECTRICAL SYSTEM

socket	E27
source	1 x max 52W
energy class	from E to A++



PACKAGING

n° cartons	2
net weight/kg	1,9 (A+B)
gross weight/kg	2,2 (A+B)
packaging/cm	21x21x20(A) - 24x24x39(B)

LIGHT EMISSION

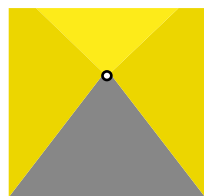



unidirectional

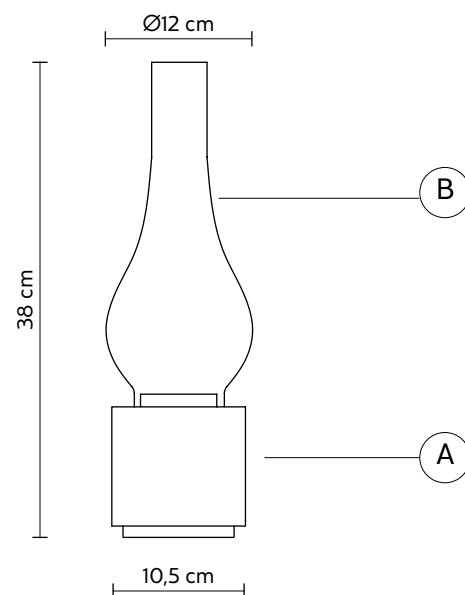

	direct
	filtered
	indirect
	absence



COMPLIANT WITH

IEC	60598-1:2014
EN	60598-1:2015
	   

degree of protection
bulb IP20
optional



article **700P***
tungsten filaments
E27 - 25/40W ≤60lumen
class E

***these items are special,
decorative bulbs not for
illumination purposes**

COLLECTION

also available wall lamp version



CT121 BF INT



CT121 BS INT



CT121 GT INT



CT121 1G INT



CT121 GS INT

AMARCORD table lamp

Matteo Ugolini design

year 2018

DATA SHEET - CT121 BF INT

BASE "A"

material	concrete	
colour	white	

DIFFUSER "B"

material	glass	
colour	smoked	

ELECTRICAL CABLE

colour	transparent	
--------	-------------	---

ELECTRICAL SYSTEM

socket	E27
source	1 x max 52W
energy class	from E to A++



PACKAGING

n° cartons	2
net weight/kg	1,9 (A+B)
gross weight/kg	2,2 (A+B)
packaging/cm	21x21x20(A) - 24x24x39(B)

LIGHT EMISSION

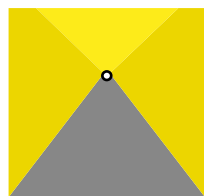



unidirectional

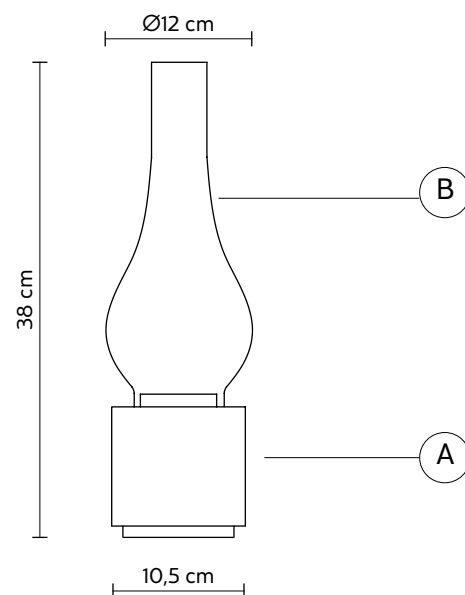

	direct
	filtered
	indirect
	absence



COMPLIANT WITH

IEC	60598-1:2014
EN	60598-1:2015
	   

degree of protection
bulb IP20
optional



article **700P***
tungsten filaments
E27 - 25/40W ≤60lumen
class E

***these items are special,
decorative bulbs not for
illumination purposes**

COLLECTION

also available wall lamp version



CT121 1B INT



CT121 BS INT



CT121 GT INT



CT121 1G INT



CT121 GS INT

AMARCORD table lamp

Matteo Ugolini design

year 2018

DATA SHEET - CT121 BS INT

BASE "A"

material	concrete	
colour	white	

DIFFUSER "B"

material	glass	
colour	frosted transparent*	

ELECTRICAL CABLE

colour	transparent	
--------	-------------	---

ELECTRICAL SYSTEM

socket	E27
source	1 x max 52W
energy class	from E to A++

PACKAGING

n° cartons	2
net weight/kg	1,9 (A+B)
gross weight/kg	2,2 (A+B)
packaging/cm	21x21x20(A) - 24x24x39(B)

LIGHT EMISSION

unidirectional



COMPLIANT WITH

IEC	60598-1:2014
EN	60598-1:2015
	
degree of protection	IP20
bulb	optional



article **700P***
tungsten filaments
E27 - 25/40W ≤60lumen
class E

***these items are special,
decorative bulbs not for
illumination purposes**

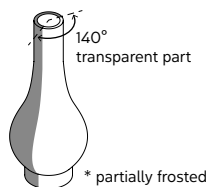
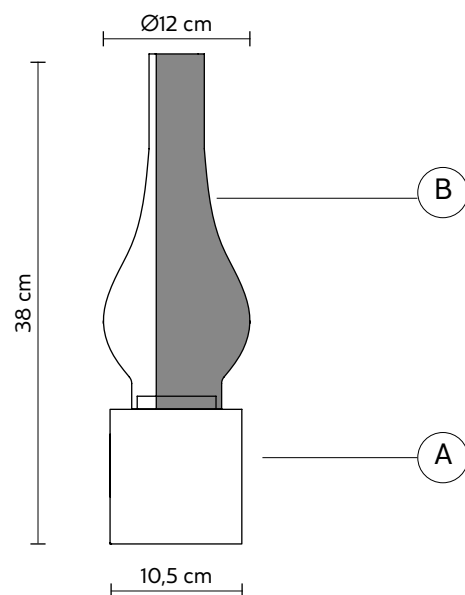

COLLECTION

also available wall lamp version

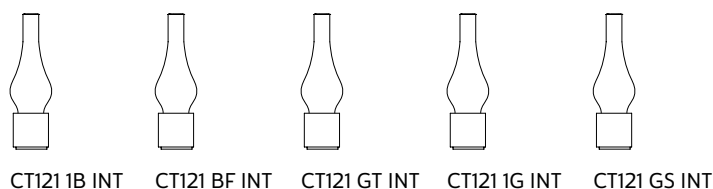

AMARCORD table lamp

Matteo Ugolini design

year 2018

DATA SHEET - CT121 GT INT

BASE "A"

material	concrete	
colour	dove grey	

DIFFUSER "B"

material	glass	
colour	transparent	

ELECTRICAL CABLE

colour	transparent	
--------	-------------	---

ELECTRICAL SYSTEM

socket	E27
source	1 x max 52W
energy class	from E to A++



PACKAGING

n° cartons	2
net weight/kg	1,9 (A+B)
gross weight/kg	2,2 (A+B)
packaging/cm	21x21x20(A) - 24x24x39(B)

LIGHT EMISSION

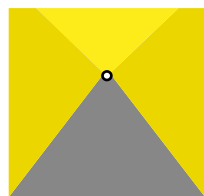



unidirectional

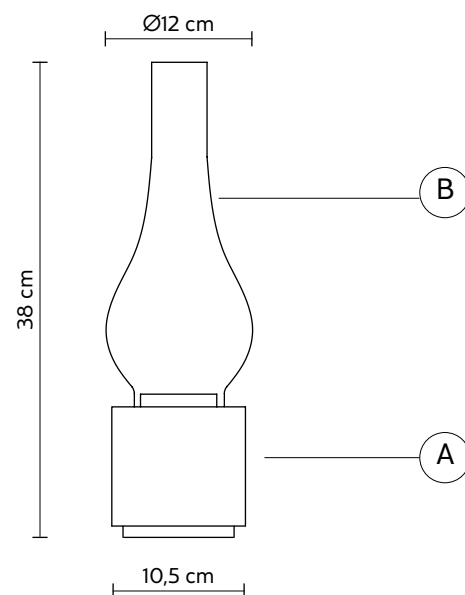

	direct
	filtered
	indirect
	absence



COMPLIANT WITH

IEC	60598-1:2014
EN	60598-1:2015
	   

degree of protection
bulb IP20
optional



article **700P***
tungsten filaments
E27 - 25/40W ≤60lumen
class E

***these items are special,
decorative bulbs not for
illumination purposes**

COLLECTION

also available wall lamp version



CT121 1B INT



CT121 BF INT



CT121 BS INT



CT121 1G INT



CT121 GS INT

AMARCORD table lamp

Matteo Ugolini design

year 2016

DATA SHEET - CT121 1G INT

BASE "A"

material	concrete	
colour	dove grey	

DIFFUSER "B"

material	glass	
colour	smoked	

ELECTRICAL CABLE

colour	transparent	
--------	-------------	---

ELECTRICAL SYSTEM

socket	E27
source	1 x max 52W
energy class	from E to A++



PACKAGING

n° cartons	2
net weight/kg	1,9 (A+B)
gross weight/kg	2,2 (A+B)
packaging/cm	21x21x20(A) - 24x24x39(B)

LIGHT EMISSION

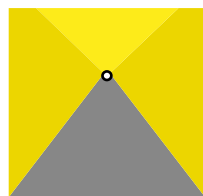



unidirectional

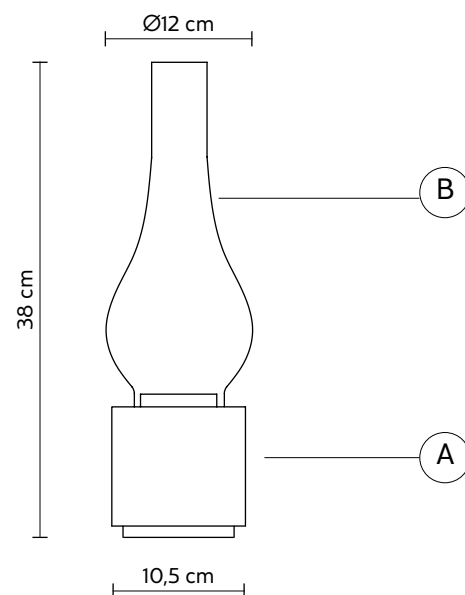

	direct
	filtered
	indirect
	absence



COMPLIANT WITH

IEC	60598-1:2014
EN	60598-1:2015
	   

degree of protection
bulb IP20
optional



article **700P***
tungsten filaments
E27 - 25/40W ≤60lumen
class E

***these items are special,
decorative bulbs not for
illumination purposes**

COLLECTION

also available wall lamp version



CT121 1B INT



CT121 BF INT



CT121 BS INT



CT121 GT INT



CT121 GS INT

AMARCORD table lamp

Matteo Ugolini design

year 2018

DATA SHEET - CT121 GS INT

BASE "A"

material	concrete	
colour	dove grey	

DIFFUSER "B"

material	glass	
colour	frosted transparent*	

ELECTRICAL CABLE

colour	transparent	
--------	-------------	---

ELECTRICAL SYSTEM

socket	E27
source	1 x max 52W
energy class	from E to A++



PACKAGING

n° cartons	2
net weight/kg	1,9
gross weight/kg	2,2
packaging/cm	21x21x20(A) - 24x24x39(B)



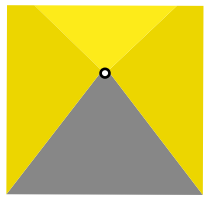

LIGHT EMISSION

unidirectional



	direct
	filtered
	indirect
	absence

COMPLIANT WITH

IEC	60598-1:2014
EN	60598-1:2015
	   

degree of protection
bulb IP20
optional



article **700P***
tungsten filaments
E27 - 25/40W ≤60lumen
class E

***these items are special,
decorative bulbs not for
illumination purposes**

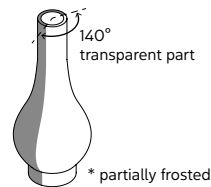
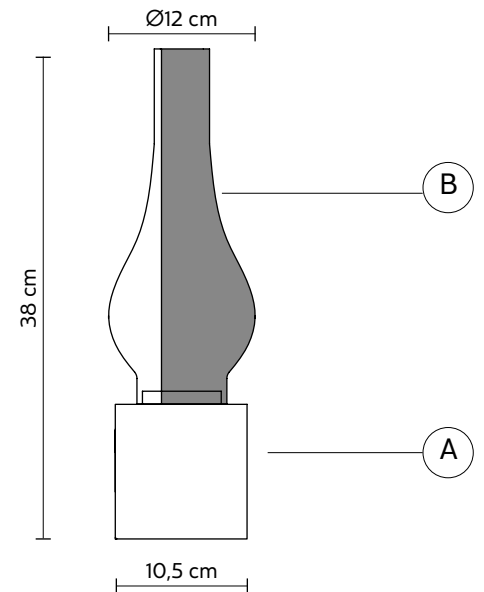

COLLECTION

also available wall lamp version

