

# ALÌ E BABÀ wall lamp

Matteo Ugolini design

year 2009/2010

## TECHNICAL SHEET - AP625CBS

### STRUCTURE "A"

material	ceramic	
colour	glossy white	

### STRUCTURE "B"

material	linen	
colour	white	

### ELECTRICAL CABLE

socket	E27
source	max 1x52w
energy class	from E to A++





### PACKAGING

nr.of collis	1
net weight/kg	2,3
gross weight/kg	3,5
packaging/cm	62x67x32

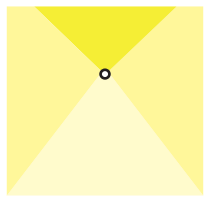
### EMISSION OF LIGHT

one directional



	direct
	filtered
	indirect
	none

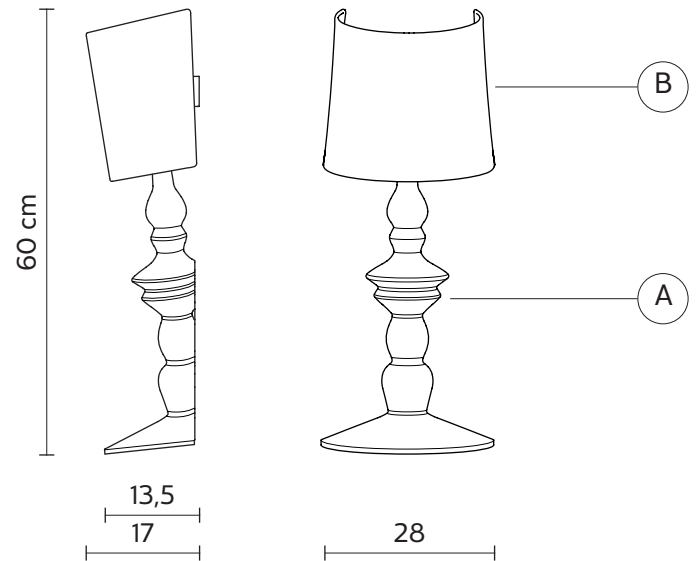

### CERTIFICATION

IEC	60598-1:2008
EN	60598-1:2008 + A11:2009



IP rate	IP20
bulb	not provided



### COLLECTION

available also as: floor lamp, suspension, table lamp



AP625



AP625B



AP625LS

# ALÌ E BABÀ wall lamp

Matteo Ugolini design

year 2009/2010

## TECHNICAL SHEET - AP625LS

### STRUCTURE "A"

material ceramic  
colour the structure can be painted/decorated at user's discretion

### STRUCTURE "B"

material linen  
colour white



### ELECTRICAL CABLE

socket E27  
source max 1x52w  
energy class from E to A++





### PACKAGING

nr.of collis 1  
net weight/kg 2,3  
gross weight/kg 3,5  
packaging/cm 62x67x32

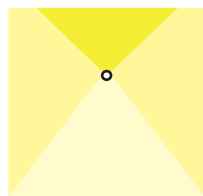
### EMISSION OF LIGHT

one directional



 direct  
 filtered  
 indirect  
 none

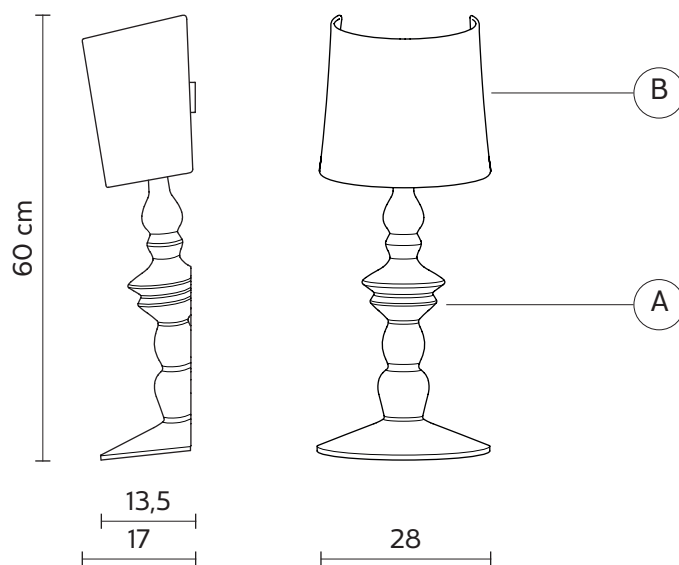

### CERTIFICATION

IEC 60598-1:2008  
EN 60598-1:2008 + A11:2009



IP rate IP20  
bulb not provided



### COLLECTION

available also as: floor lamp, suspension, table lamp



AP625



AP625B



AP625CBS