

low tech
life in progress clock

 share some pics of your interior #lyonbeton

general comments

Read the instruction carefully before assembly.

Identify the different parts of the product. Group and check the hardware fittings. Get the necessary and keep the area clear before you begin assembly.

The assembly should be carried out by a qualified person because wrong assembly may lead to that the furniture topples or falls resulting in personal injury or damage.

Proceed to assemble. Never force the fittings.

Re-tighten the screws after some time of usage.

Keep the assembly instructions for future reference. They could facilitate communication with your store or dealer, in the event of any query.

distinctive features

The article that you have just acquired is hand-crafted.

It is made from lightened fibrous concrete (less than 2 tons per m³) reinforced with a steel frame structure. It is composed of natural materials (cement, sand, water, steel ad fibres) and is hand made.

The pores, microcracks and possible variation in colour are inherent characteristics of the material used and evidence of handicraft, which give this furniture its unique appearance and charm. For these reasons, this article cannot be returned or exchanged.

maintenance and care

Do not leave spills unattended.

Immediately clean coloured stains (such as red wine, oil, tea and coffee) with a wet sponge and soap.

Never use abrasive product, strong acid detergents, bleaching agents, metal brushes or high-pressure cleaners. Preferably use a soft clean dry cloth.

For good protection, apply wax or stone preserve products regularly.

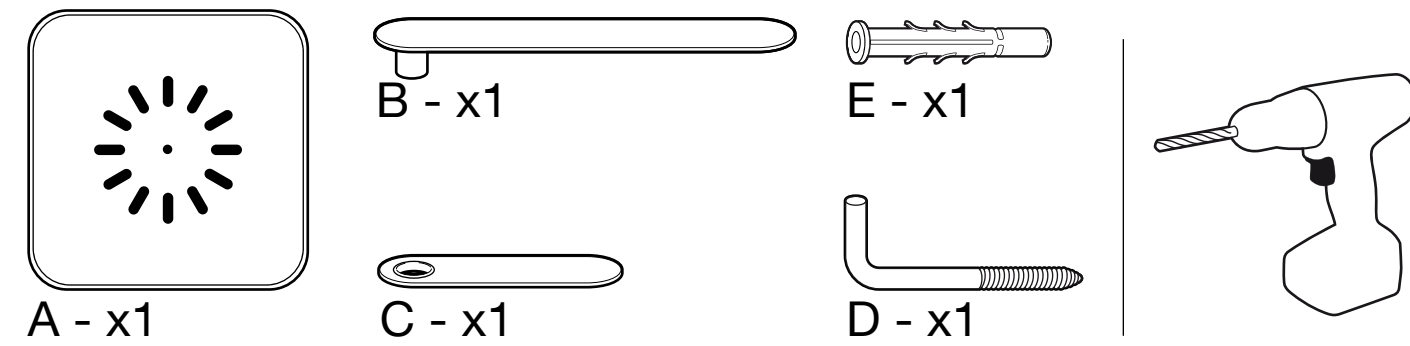

français

Le montage doit être effectué par une personne compétente. Un montage mal effectué peut provoquer la chute de l'objet et blesser quelqu'un.

ATTENTION ! Les vis et quincaillerie fournies pour fixer le meuble/objet au mur ou au plafond ne sont pas adaptées à tous les matériaux. Adaptez les vis et quincaillerie au matériau du mur/plafond et au poids de l'objet. En cas de doute, demandez conseil à un vendeur spécialisé.

english

The assembly should be carried out by a qualified person due to the fact that wrong assembly can lead to that the furniture/object topples or falls resulting in personal injury or damage.

NOTE! Screws or fittings included to fix the furniture/object to the wall/ceiling are not suitable to all materials. Always choose screws and fittings that are specially suited to the material in your wall/ceiling and have sufficient holding power.

In case of hesitation, contact your local retailer.

1

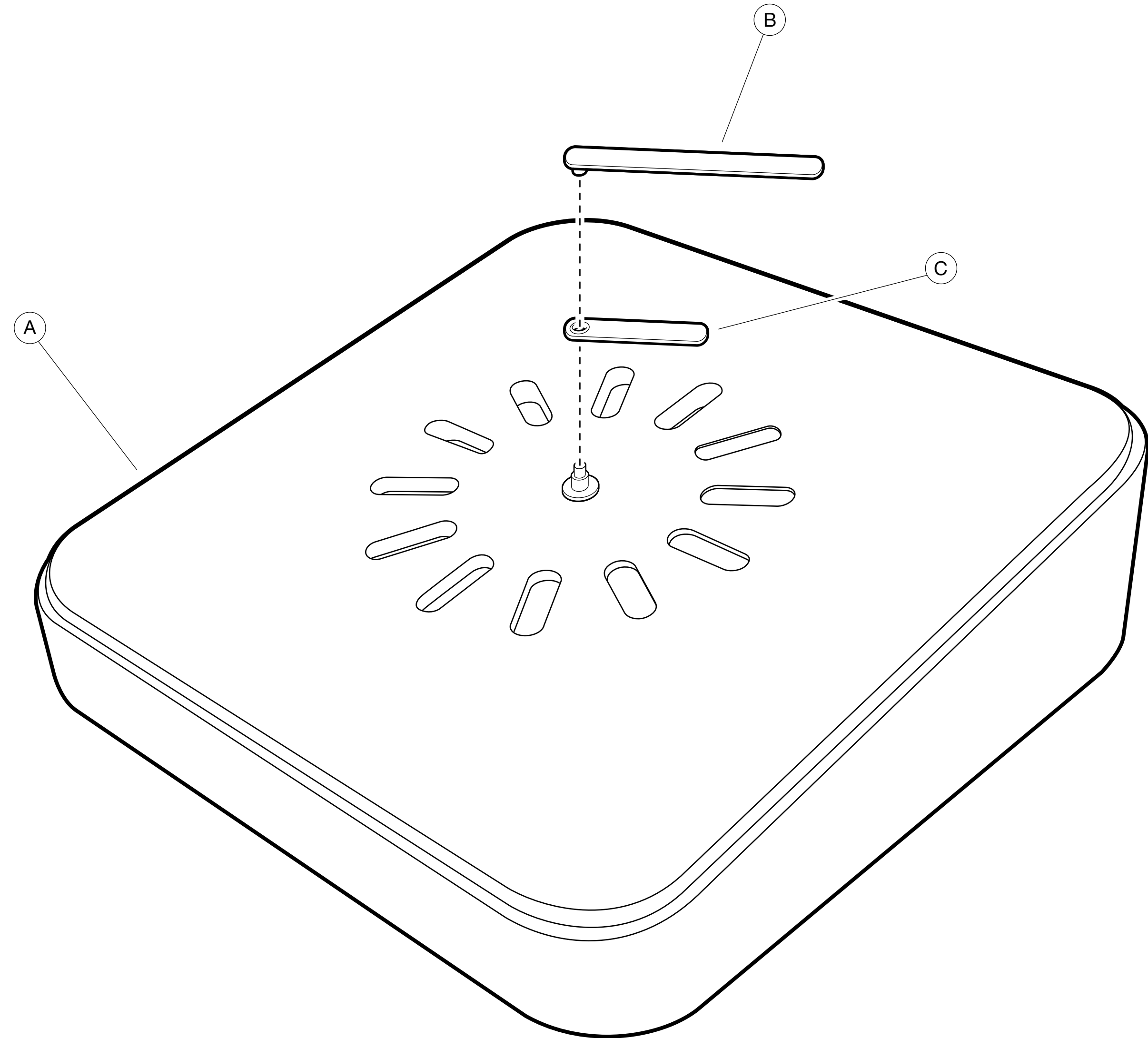

**english**

Gently maintain the movement system wheel while turning the minute hand.

français

Maintenir la molette de réglage de l'heure bloquée simultanément lors du serrage de l'aiguille des minutes.

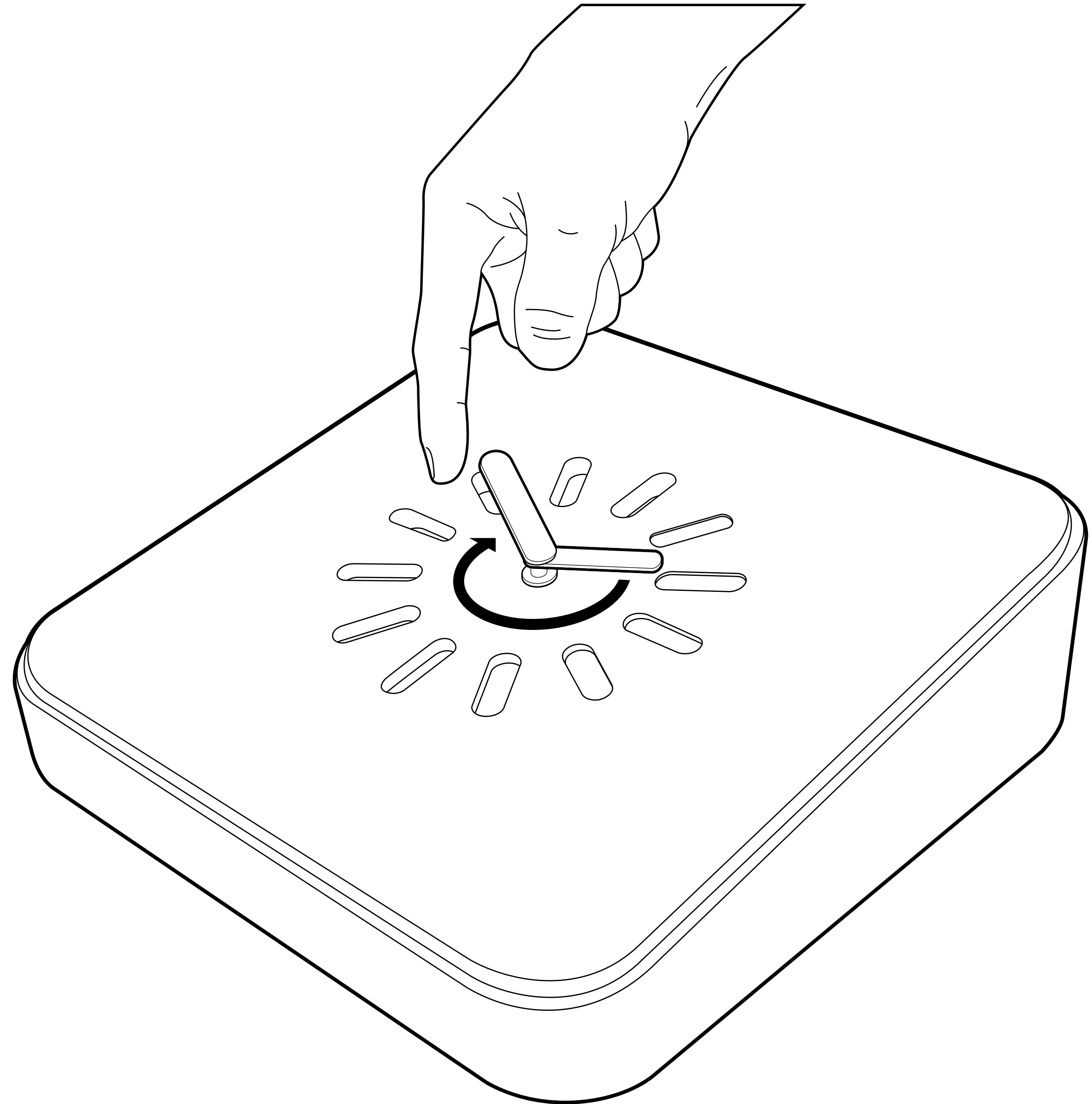
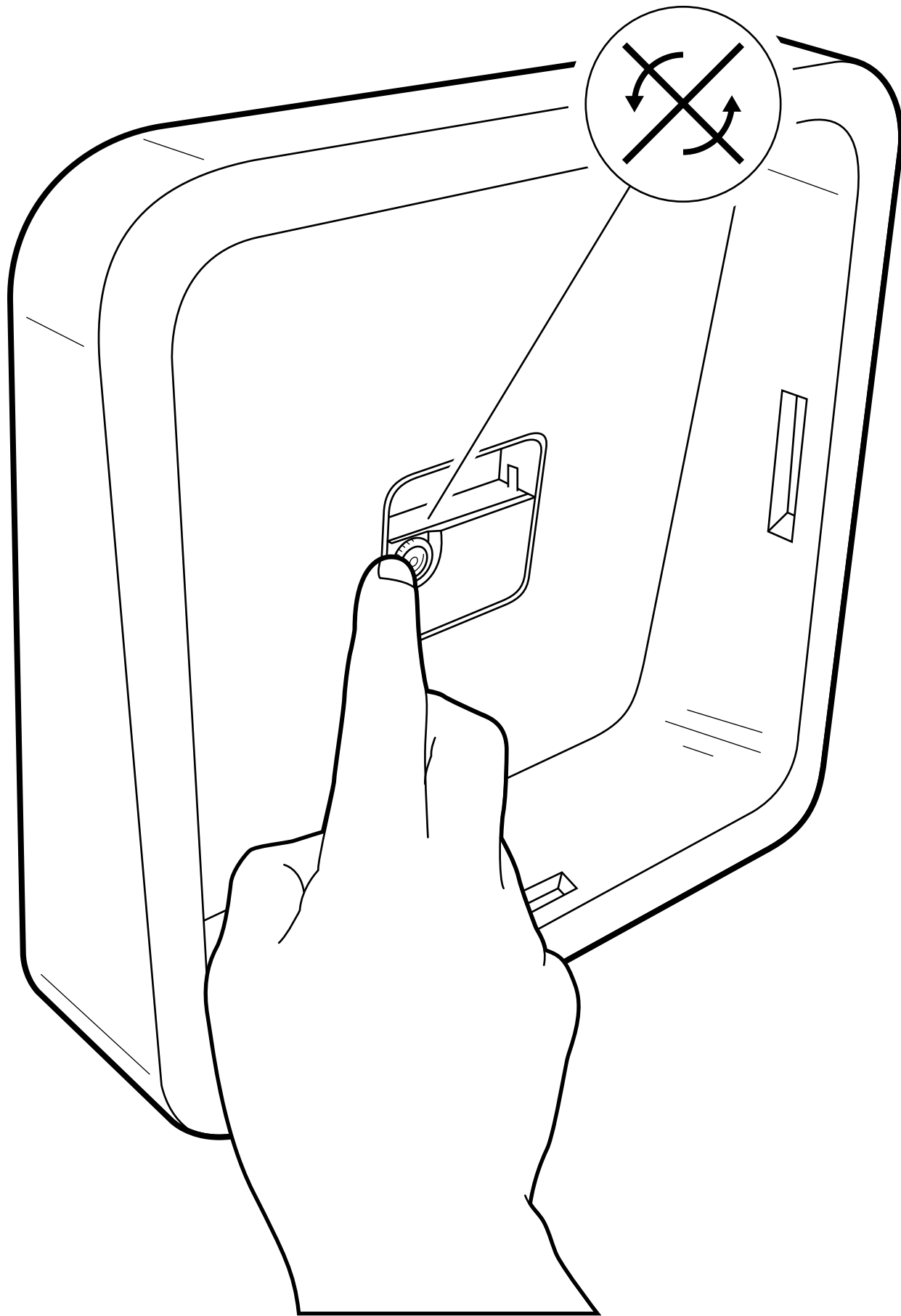

3

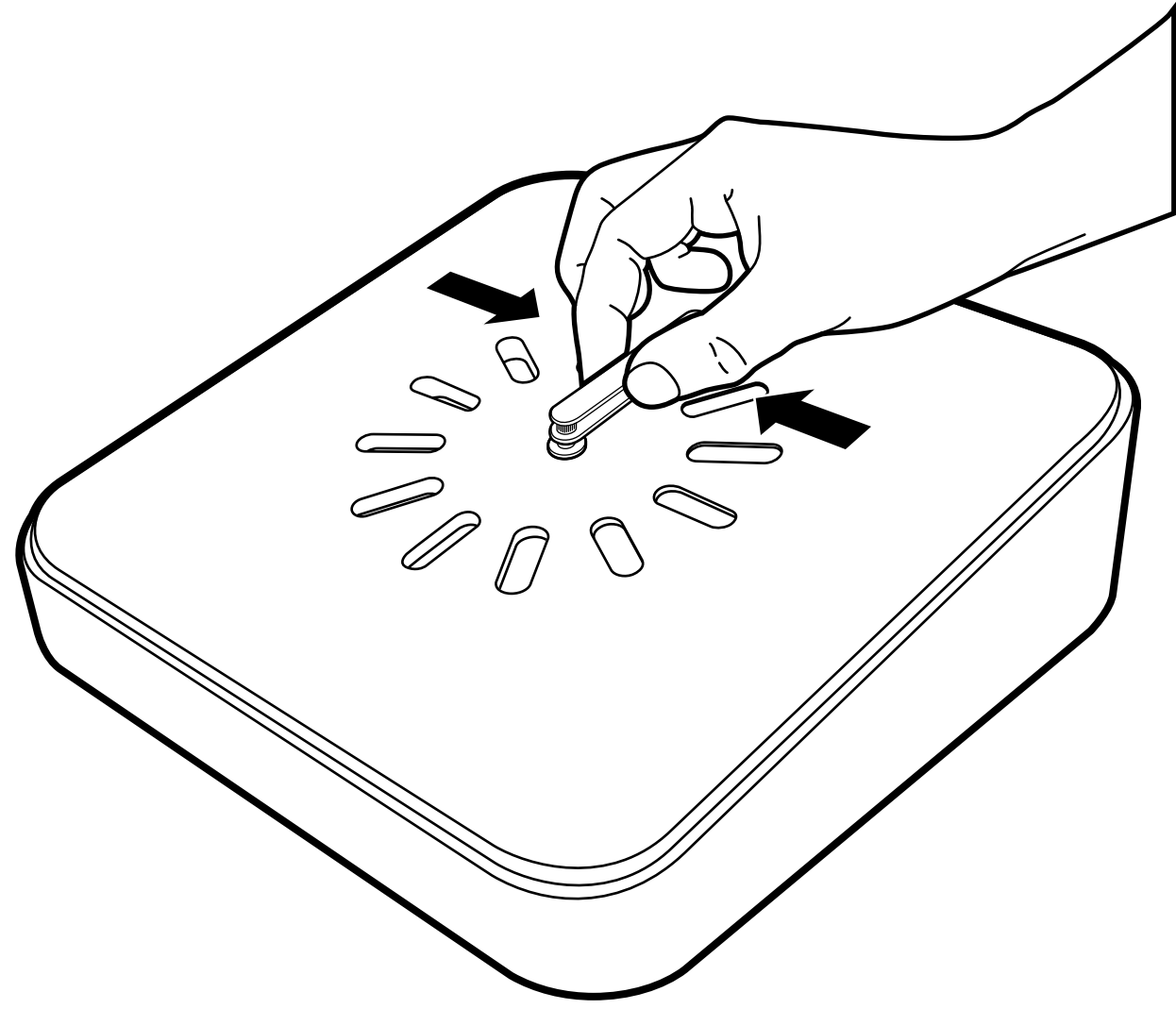

4

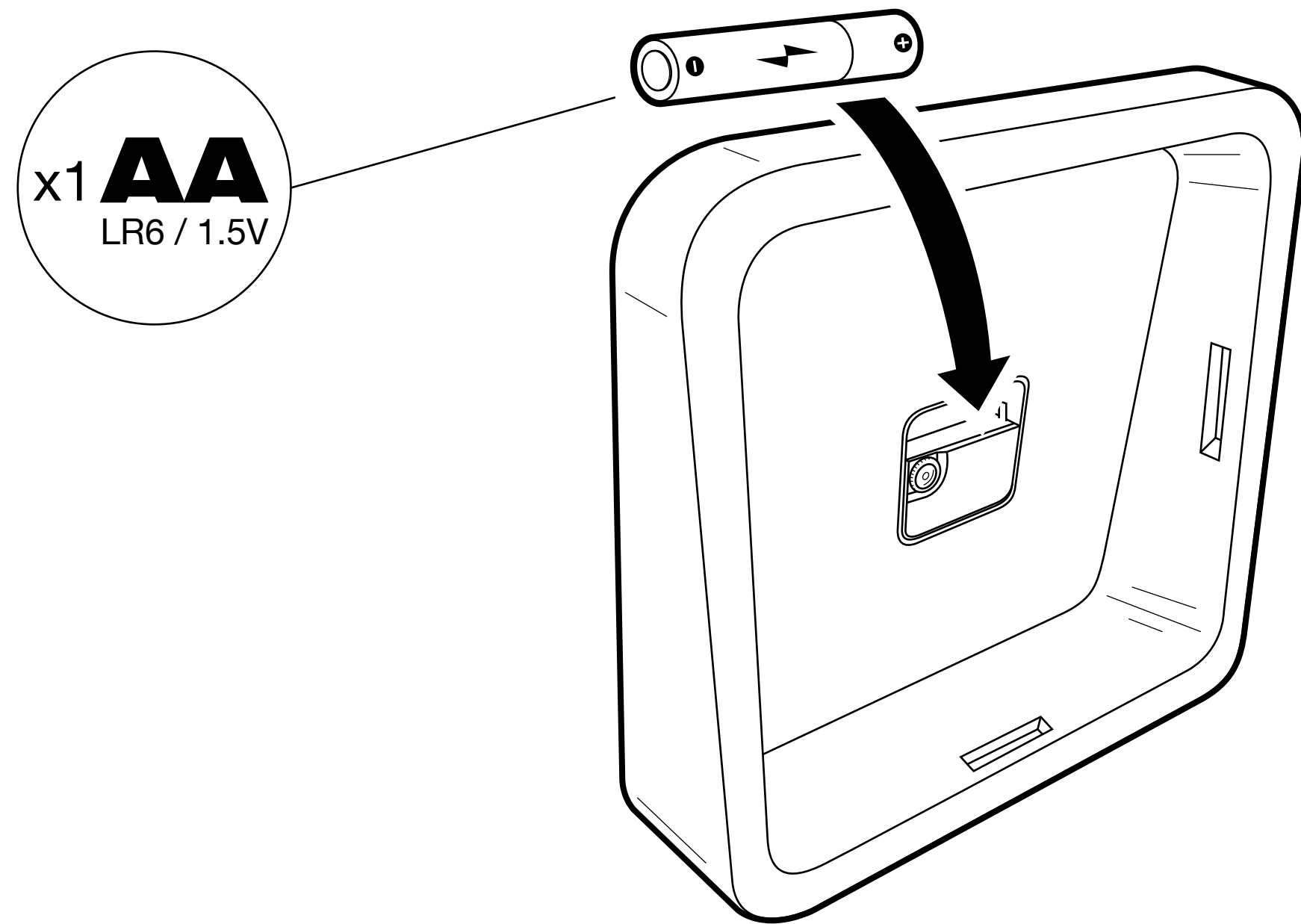

5

