

CHARLOTTE TRIPLE
CENTER TABLE

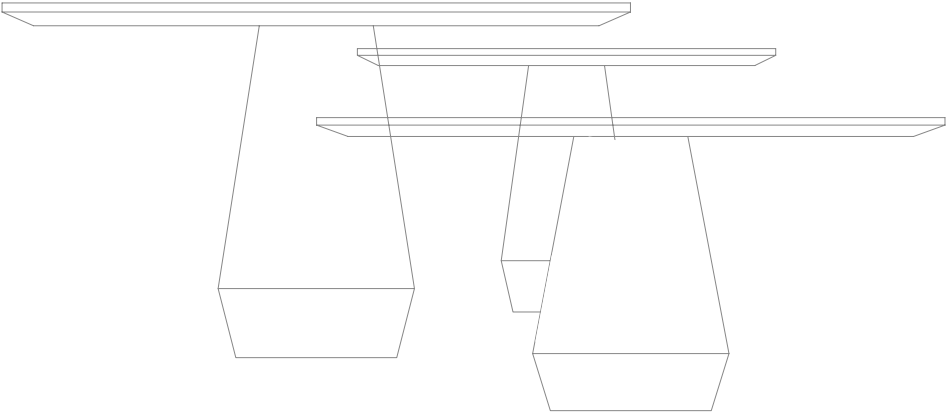

COLLECTOR
WWW.COLLECTORGROUP.PT

CHARLOTTE TRIPLE CENTER TABLE



CHARLOTTE1:

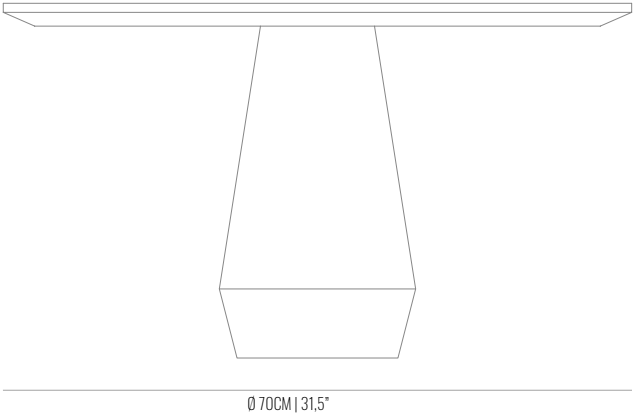

CHARLOTTE2:

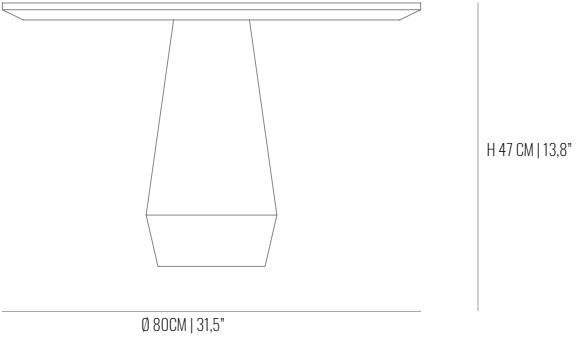

CHARLOTTE3:

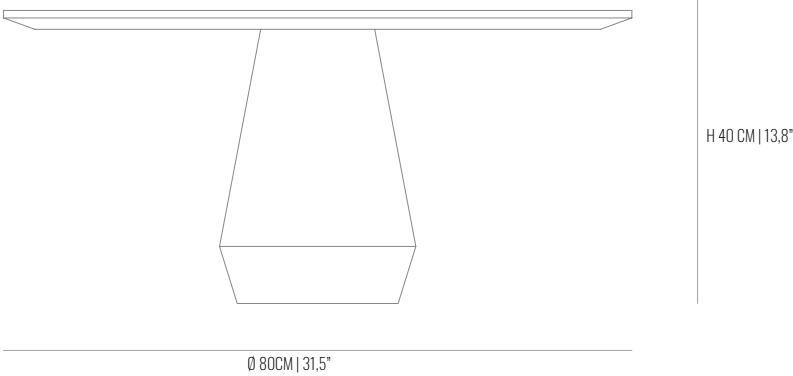

CHARLOTTE TRIPLE CENTER TABLE

CHARLOTTE1:

Ø 70CM | 31,5" H 54 CM | 13,8"

CHARLOTTE2:

Ø 70CM | 31,5" H 47 CM | 13,8"

CHARLOTTE3:

Ø 80CM | 31,5" H 40 CM | 13,8"

PRODUCT FEATURES

STRUCTURE IN SOLID OAK WOOD

PRODUCT OPTIONS

WOOD FINISHES:

AVAILABLE IN ALL COLLECTOR WOODS SWATCHES.

WOOD



Oak



Walnut



Dark Oak



Smoked Oak

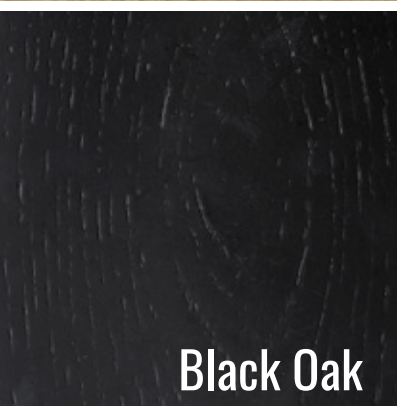

Black Oak



Kaki

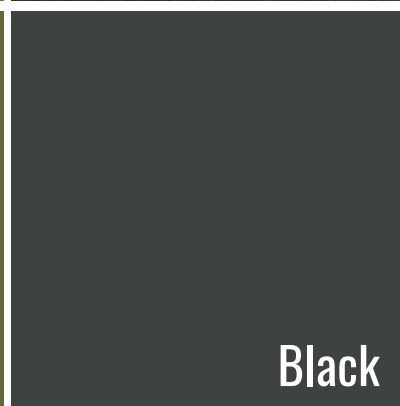

Black

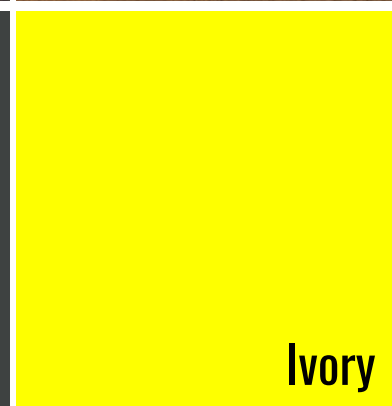

Ivory