

Professional 2023/24

Issue No. 03



bordbar →
INTERIOR TROLLEYS SINCE 2006

✈ Professional 2023/24

We transform aircraft trolleys into design objects. Our claim: combining the trolleys' inimitable aviation spirit with excellent design and ingenious functionality. The result is the bordbar Trolley - a new generation of timeless furniture pieces that adapt to every living and working environment. Flexible and on light wheels. Hand-crafted from robust materials. The consistent quality of our bordbar Trolleys is matched by the relationships we build with the people we work with. We look forward to working with you. Welcome aboard!



About bordbar

The Original – Since 2006

Wir machen Flugzeugtrolleys zu Designobjekten. Unser Anspruch: Den unverwechselbaren Flugsgeist der Trolleys mit exzellentem Design und durchdachter Funktionalität zu vereinen. Das Ergebnis: der bordbar Trolley als neue Generation zeitlos gestalteter Einrichtungsgegenstände, die sich jeder Wohn- und Arbeitsumgebung anpassen. Flexibel und auf leichten Rollen. Von Hand gefertigt aus robusten Materialien.

Genauso beständig wie die Qualität unserer bordbar Trolleys sind auch die Beziehungen zu den Menschen, mit denen wir arbeiten. Wir freuen uns auf die Zusammenarbeit mit Ihnen. Willkommen an Bord!

Content

bordbar Trolley

- 10–17 [storage & office equipment](#)
- 18–27 [minibar, lounge, bar equipment](#)
- 28–37 [coffee, serving equipment & Customized Equipment for Hotel Rooms](#)
- 38–45 [wellness equipment & Customized Equipment for Fitness Rooms](#)

bordbar Box

- 46–53 [coffeetable & bedside table equipment](#)
- 54–61 [office & stool equipment](#)

bordbar Hightable

- 62–67 [bordbar_hightable & bordbar_hightable_by_JANUA](#)

bordbar Design Service

- 68–81 [Customized Design](#)

bordbar Outdoor

- 82–87 [Outdoor Proofed and Stainless](#)

bordbar Products

- 88–99 [bordbar Product Overview](#)

Easy and Flexible Configuration: One Corpus, Countless Possibilities.



1. Der Korpus

Der Korpus bildet die Basis der bordbar. Er ist aus luftfahrtzertifizierten Materialien – robust und individuell, neu gefertigt aus 250 Einzelteilen.

1. The Body

The body is the backbone of the bordbar. It is made from aviation-certified materials – robust and individual, crafted new from 250 individual parts.



2. Das Design

Jeder Korpus bringt seine eigene Designlinie mit. Doch er ist durchaus flexibel: Unser Design-Team gestaltet ihn auch gerne ganz individuell nach Kundenwunsch.

2. The Design

Each body has its own design line. But it is amazingly flexible: our design team is happy to customize and tailor it to customer preferences.



3. Das Equipment

Durchdacht bis ins Innere: Unsere vielfältigen Equipment-Varianten machen aus jeder bordbar einen perfekten strukturierten Helfer – passgenau konfigurierbar für jede Arbeitsumgebung.

3. The Equipment

Ingenious design right down to the interior: our wide range of equipment options allows you to turn any bordbar into your dream helper – ready to be calibrated perfectly to any work setting.

bordbar Trolley



A Workspace That Stays Versatile.

Ein Blick in die Zukunft: Das Büro als Raum wird es weiterhin geben. Jedoch ohne starre Muster, konzipiert für flexible Arbeitswelten und agile Raumkonzepte.

Fast forward to the future: the office as a space is here to stay. But this time it's liberated from rigid structures – designed for flexible working environments and agile space concepts.





bordbar_storage equipment

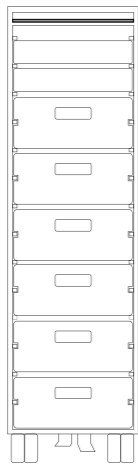

Equipment-Zusammenstellung:

- Filzabdeckung hellgrau
- 2x Aluminium-Schubkasten, schmal
- 6x Aluminium-Schubkasten, standard

Equipment-Compilation:

- light grey felt cover plate
- 2x aluminium drawers, small
- 6x aluminium drawers, standard



bordbar_new with office equipment



bordbar_office equipment

Die schlanke Working Station sorgt mithilfe des bordbar_office equipments auf gerade mal 0,12 qm Fläche für Ordnung und Struktur.

Thanks to its bordbar_office equipment, this slimline working station ensures order and structure, occupying an area of just 0.12 square meters.

Versatile Storage

Alle bordbars stehen für Individualität, Langlebigkeit und höchste Qualität. In Kombination mit dem bordbar_office equipment werden aus ihnen smarte Assistenten, die sich individuell für jede Arbeitsumgebung konfigurieren lassen.

All bordbars stand for individuality, durability and the highest quality. In combination with bordbar_office equipment, they become smart assistants that can be individually configured for any work environment

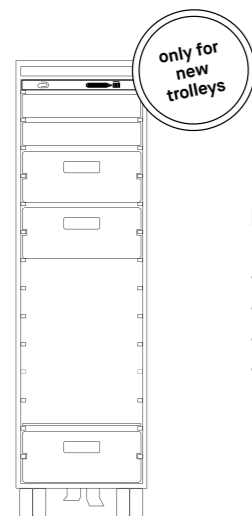

Equipment-Zusammenstellung:

- Büro-Schubkasten
- 2x Aluminium-Schubkasten, schmal
- 3x Aluminium-Schubkasten, standard
- Fachboden

Equipment-compilation:

- stationery tray
- 2x aluminium drawers, small
- 3x aluminium drawers, standard
- aluminium shelf



bordbar_new with office equipment in the network black lines design



minibar, lounge & bar equipment

Hospitality Anytime and Anywhere.

Die besten Gespräche führt man bei einem stilvoll servierten Drink: Mit der mobilen bordbar werden aus kleinen Pausen produktive Auszeiten – bei Konferenzen genauso wie in einer ruhigen Minute in der Hotellobby.

The best conversations happen over drinks served in style: The mobile bordbar turns short breaks into productive breathers - at conferences or just catching a quiet minute in the hotel lobby.





Refreshing Drinks for Conference Rooms

Die maßgefertigte, mobile bordbar hält jederzeit eine kühle Erfrischung bereit. First Class Service – überall einsetzbar.

Your custom-built mobile bordbar means you can enjoy chilled drinks anywhere, anytime. First class service - wherever you want it.



bordbar_minibar equipment

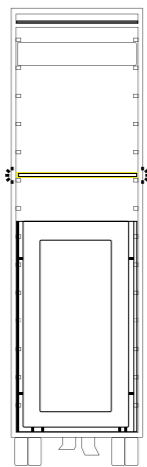

Equipment-Zusammenstellung:

- Filzabdeckung hellgrau
- Aluminium-Schubkasten, schmal
- LED-Leuchtfachboden
- bordbar_cooler

Equipment-compilation:

- light grey felt cover plate
- aluminium drawer, small
- LED multicolored shelf
- bordbar_cooler



bordbar_new with minibar equipment in the passport white design



bordbar_lounge equipment

Das hochwertige bordbar_lounge equipment mit einem Humidor für Zigarren präsentiert edle Rauchwaren genauso elegant wie ausgesuchte Getränke.

The high-quality bordbar_lounge equipment set with a humidor for cigars showcases premium tobacco products just as elegantly as it does curated beverages.



Equipment-Zusammenstellung: Equipment-compilation:

- | | |
|---------------------------------|---------------------------|
| • Aluminium-Schubkasten, schmal | • aluminium drawer, small |
| • bordbar_humidor | • bordbar_humidor |
| • Glas-Fachboden | • glass shelf |
| • LED-Leuchtfachboden | • LED multicolored shelf |



bordbar_bar equipment

Viel Platz für guten Geschmack: Das bordbar_bar equipment bereichert jede Situation mit einer Auswahl an exquisiten Drinks.

Oodles of space for good taste(s): the bordbar_bar equipment set adds that special touch to every setting with a selection of exquisite drinks.



Equipment-Zusammenstellung: **Equipment-compilation:**

- LED-Leuchtfachboden
- Glas-Fachboden
- LED multicolored shelf
- glass shelf

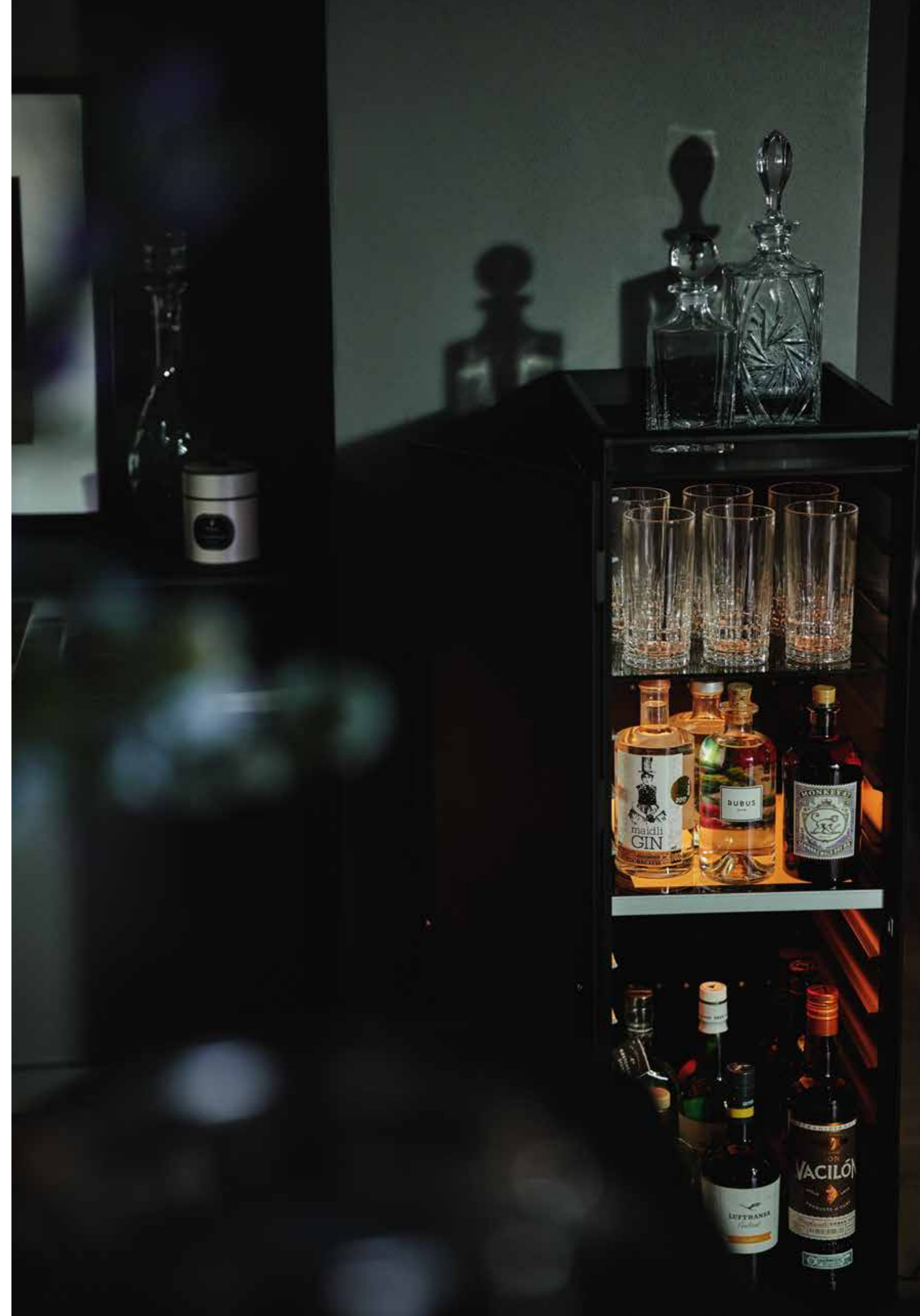

[BACK TO CONTENT](#)



coffee, serving equipment & Customized Equipment for Hotel Rooms

There to Serve. And to Make Time Fly.

Menschen brauchen Auszeiten – die bordbar schenkt sie ihnen: Bei einem Kaffee in der Arbeitspause genauso wie in der Ruhe eines komfortablen Hotelzimmers.

People need the chance to kick back and relax - the bordbar gives them just that: over a coffee during a break at work or in the peace and quiet of a their hotel room.





Mobile Coffee Bar

Die perfekte Kaffeebar: Nespresso-Fachböden, Schubladen, Fachböden aus Glas sowie Flaschenfachböden sorgen für viel Platz und durchdachten Stauraum.

The perfect coffee bar: Nespresso shelves, drawers, glass shelves and bottle compartments ensure plenty of space and ingenious storage.





rivet rocker_new in the American Airlines design



bordbar_new with coffee equipment in the airports design

bordbar_coffee equipment



Equipment-Zusammenstellung:

- Abdeckplatte, silber
- 2x Nespresso-Fachboden
- Kunststoff-Schubkasten
- Schubkasten-Besteckeinsatz
- 3x Glas-Fachboden
- Flaschen-Fachboden

Equipment-compilation:

- cover plate in aluminium
- 2x shelves for Nespresso capsules
- drawer synthetic material
- cutlery tray for drawer
- 3x glass shelves
- shelf for bottles



bordbar_black with serving equipment in a customized design

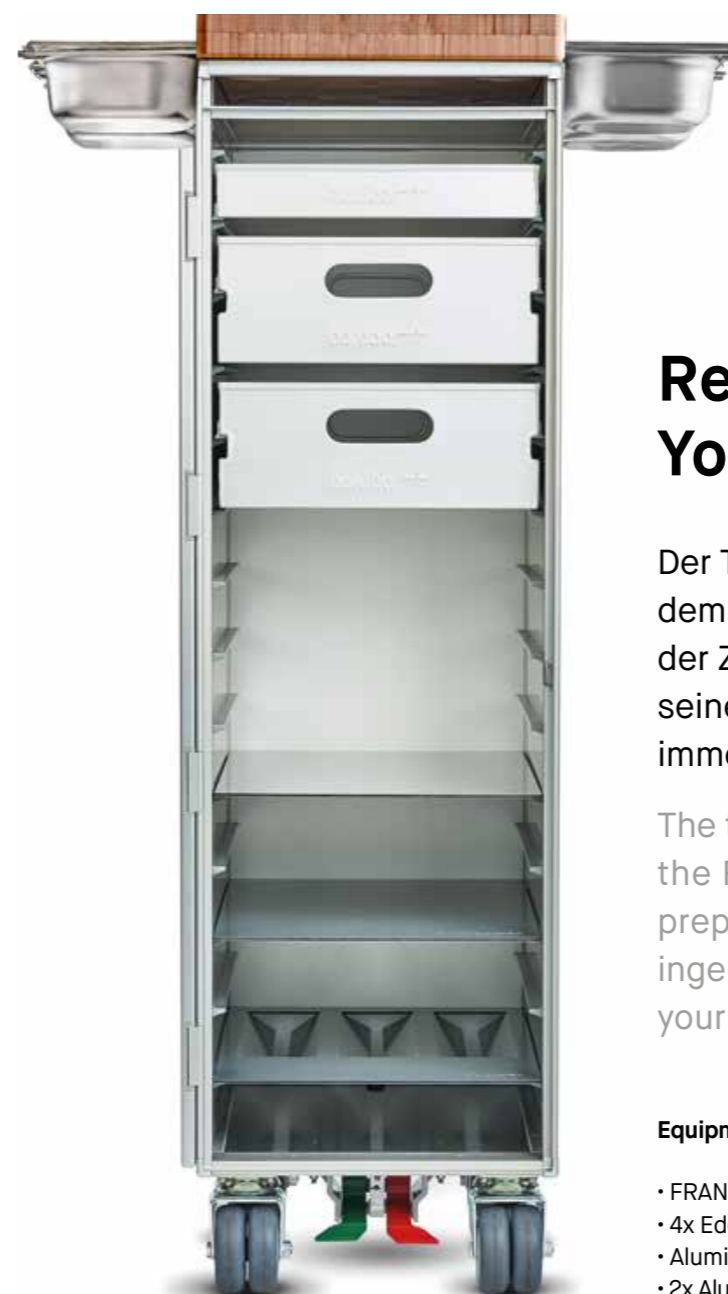

Ready When You Are

Der Trolley mit serving equipment inklusive dem FRANKFURTER BRETT unterstützt bei der Zubereitung und beim Servieren. Dank seiner smarten Aufteilung sind alle Zutaten immer griffbereit.

The trolley with serving equipment including the FRANKFURTER BRETT makes food prep and serving child's play. Thanks to its ingenious organization, you always have all your ingredients to hand.

Equipment-Zusammenstellung:

- FRANKFURTER BRETT
- 4x Edelstahlbehälter
- Aluminium- Schubkasten, schmal
- 2x Aluminium- Schubkasten, standard
- 2x Fachboden
- Flaschen-Fachboden

Equipment-compilation:

- FRANKFURTER BRETT
- 4x stainless steel containers
- aluminium drawer, small
- 2x aluminium drawers, standard
- 2x aluminium shelves
- shelf for bottles



Professional Equipment for Hotel Rooms

Ein morgendlicher Kaffee im Bett oder ein kühles Getränk mit Snack am Abend? Die individuell konfigurierbare bordbar sorgt auch im Hotelzimmer für mehr Gästekomfort.

A cozy morning coffee in bed or a chilled drink in the evening with a snack? Our customizable bordbar ensures hotels guests can enjoy premium comfort too.

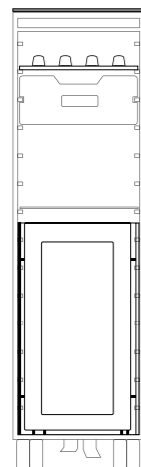

Equipment-Zusammenstellung:

- Abdeckplatte, silber
- Nespresso-Fachboden
- Fachboden
- bordbar_cooler



Equipment-compilation:

- cover plate in aluminium
- shelf for Nespresso capsules
- aluminium shelf
- bordbar_cooler





wellness equipment & Customized Equipment for Fitness Rooms

In Perfect Shape to Make People Relax.

Feuchtigkeitsresistent, langlebig und harmonisch im Design: Die bordbar sorgt als Herzstück jedes Spa-Bereichs für eine ausgeglichene Raumatmosphäre.

With its damp-proof, durable and harmonious design, the bordbar is the heart of any spa area, creating a balanced ambience.

Enjoy Every Moment

Mit ihrem wellness equipment bietet die bordbar wertvollen Stauraum für alles, was den Spa-Bereich täglich zum Erlebnis macht.

With its wellness_equipment, the bordbar provides valuable storage space for everything you need for the perfect spa experience.





bordbar_new in the network white lines design

bordbar_wellness equipment

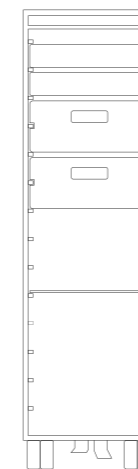

Equipment-Zusammenstellung:

- Filzabdeckung hellgrau
- 2x Aluminium-Schubkasten, schmal
- 6x Aluminium-Schubkasten, standard

Equipment-compilation:

- light grey felt cover plate
- 2x aluminium drawers, small
- 6x aluminium drawers, standard



Professional Equipment for Fitness Rooms

Workout in neuer Form: Die bordbar stemmt in ihren Fächern mühelos Trainingsequipment und schafft Platz für kühle Erfrischungsgetränke.

Workout reloaded: the bordbar effortlessly accommodates your training equipment and keeps chilled drinks at the ready, too.

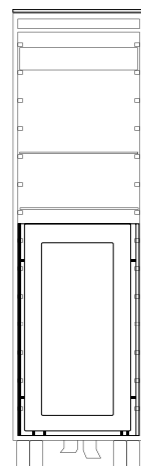

Equipment-Zusammenstellung:

- Aluminium-Schubkasten, schmal
- 2x Fachboden
- bordbar_cooler

Equipment-compilation:

- drawer aluminium small
- 2x aluminium shelves
- bordbar_cooler





bordbar
Box



coffeetable & bedside table equipment

A Small Space, Extensively Smart.

Flexibilität ist ihre wahre Größe: Die zeitlos designte bordbar_box bietet mit ihrer unaufdringlichen Funktionalität unzählige Einsatzmöglichkeiten. In Kombination mit ihrem Zubehör ist sie bereit, sich immer wieder neu erfinden zu lassen.

Flexibility is the name of the game: with its unobtrusive functionality, the timeless bordbar_box offers countless possible uses. In combination with its equipment sets, it can be reinvented again and again.

UM





bordbar_box coffeetable equipment

Für Lesestoff und das passende Getränk dazu:
Unsere bordbar_box mit coffeetable equipment
verwandelt Warteräume und Loungebereiche in
genussvolle Ruhezonen.

For reading material and the perfect drink to
accompany it: Our bordbar_box with coffeetable
equipment transforms waiting rooms and lounge
areas into luxurious oases of calm.



bordbar_box bedsidetable equipment

Damit sich Hotelgäste schnell wie zu Hause fühlen: Die bordbar_box ist ein bewegliches Nachtschränkchen mit Platz für Zeitschriften und persönliche Dinge.

Make your hotel guests feel right at home: The bordbar_box is a mobile nightstand with space for newspapers and personal items.



[BACK TO CONTENT](#)



office & stool equipment

Flexible Boxes for Successful Working.

Klein und wendig: Die bordbar_box ist ein kompletter flexibler Arbeitsplatz. In Co-Working-Spaces passt sie unter jeden Schreibtisch und macht auch als Sitzgelegenheit eine gute Figur.

Small and nimble: The bordbar_box is a completely flexible workstation. It fits under any desk in co-working spaces and even doubles as an impromptu seat.





Reference: Hell und Freundlich for Berner | **bordbar_box_black**



Reference: Hell und Freundlich for Berner | **bordbar_box_black**

New Versatile Coworkers

Wo fließen heute die Ideen? Die abschließbare bordbar_box bewegt sich an jeden Platz im Büro und ist ein sicherer Ort für wichtige Unterlagen.

Where is the magic happening today? The lockable bordbar_box moves to any place in the office, securely storing important documents.

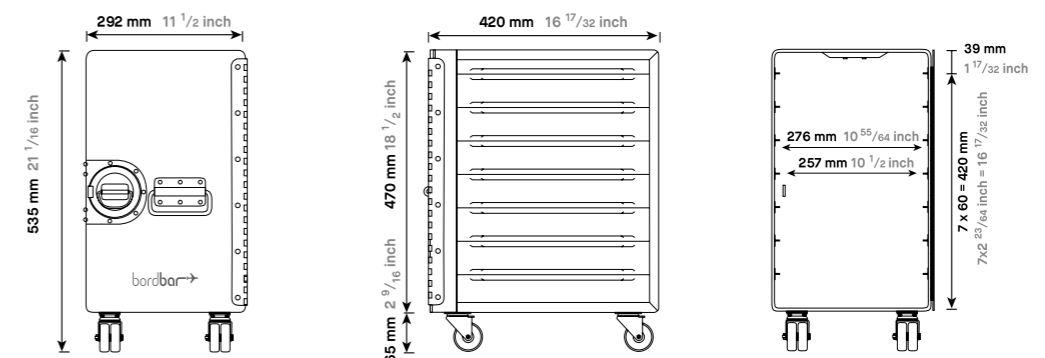



bordbar_box_white with office equipment

bordbar_box office equipment

Hier haben Schreibutensilien und Laptops bis zu 13" ihren festen Platz: Das office equipment bietet praktische Schubladen und genügend Platz für Büromaterial.

The perfect home for stationery and laptops (up to 13"). The office equipment set offers convenient drawers and plenty of space for office supplies.



bordbar_box_white with office equipment



bordbar_box_black with leather cushion



bordbar_box stool equipment

Für spontane Meetings: Das stool equipment mit Lederkissen erschafft im Handumdrehen eine bequeme Sitzgelegenheit und hält alle Dokumente für die Besprechung griffbereit.

For impromptu meetings: our stool equipment featuring a leather cushion creates a comfy seat in the blink of an eye and makes sure all your meeting documents are to hand.



bordbar
Hightable

[BACK TO CONTENT](#)



bordbar_hightable & bordbar_hightable_by_JANUA

Well grounded. Highly flexible.



It's a match! Als Steharbeitsplatz, Meetingpoint oder einladender Bartisch: Die einzelnen Hightable-Module lassen sich für jede Situation spielend leicht anpassen.

It's a match. Stand-up desk, meeting point or inviting bar table. The individual hightable modules can be easily adapted to fit any situation.



bordbar_new with bordbar_hightable_white in the destination white design



rivet rocker_black mit bordbar_hightable_black_by JANUA (Eiche natur)

bordbar_hightable & bordbar_hightable x JANUA

Der modular konzipierte bordbar_hightable lässt sich überall dort aufstellen, wo er gerade gebraucht wird. Beweglich, praktisch und auf Wunsch auch im exquisiten JANUA Design.

As a modular piece of furniture, the bordbar_hightable can be conveniently placed wherever it is needed. Mobile and practical, it is also available in the exquisite JANUA design.

bordbar
Design Service



[BACK TO CONTENT](#)



Customized Design

Say It in Your Words.



Reference: Birkenstock – Headquarter Australia | **bordbar_new** in a customized design



Reference: Kahl – Securitas | **bordbar_new** in a customized design

Unique Corporate Design

Gutes Design ist immer einzigartig und klar. Noch individueller wird es durch ein personalisiertes Branding oder eine charmante Botschaft.

Good design is always uncompromising and unique. It's even more unique with personalized branding or an engaging message.



Perfect for Every Occasion

Flexibel in Design und Funktionalität: Die bordbar passt sich jedem Business Event an und bereichert spielend den Service.

Versatile design and function: The bordbar adapts to every business event, playfully taking service to the next level.



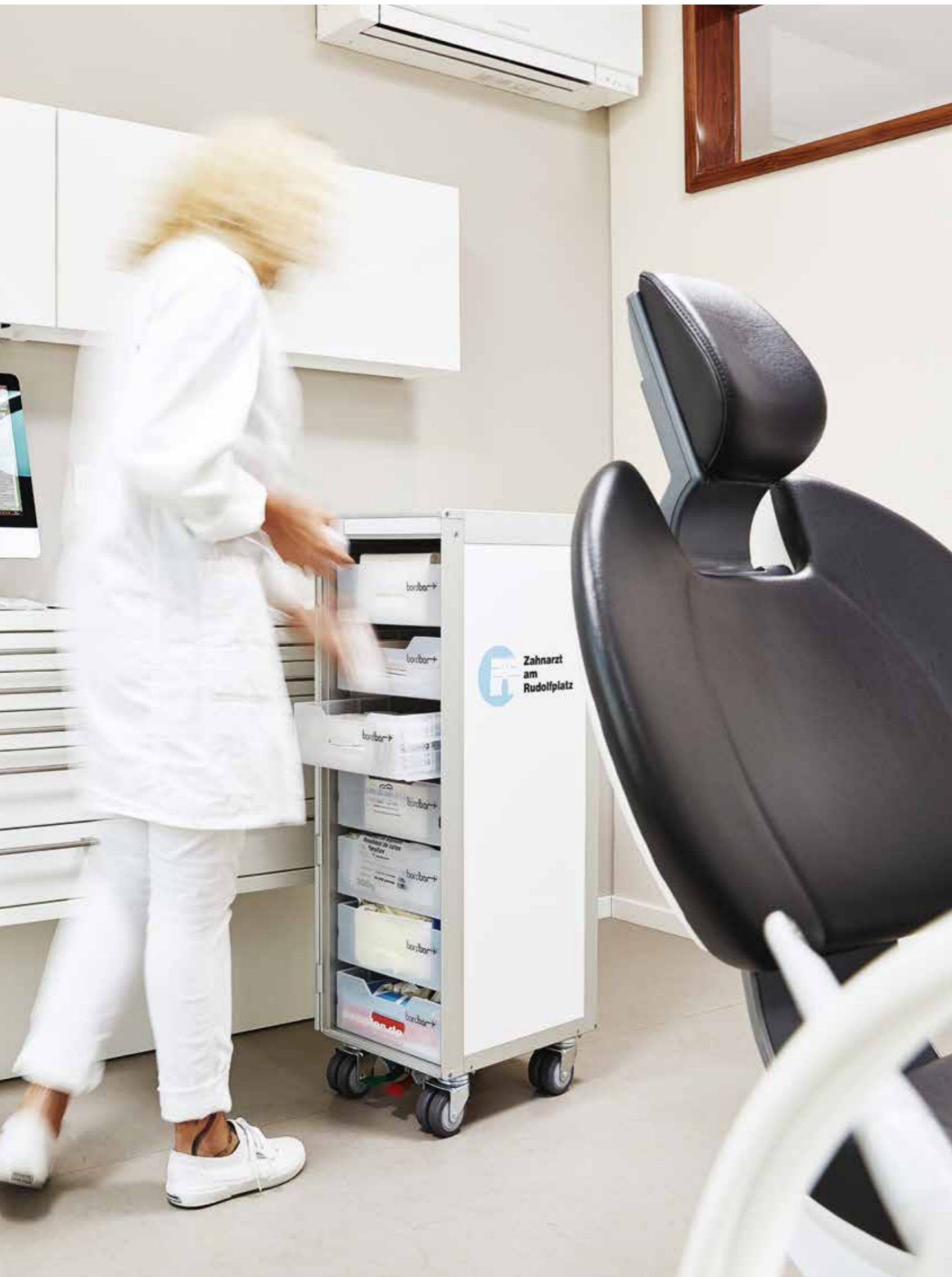

Reference: Zahnarzt am Rudolfplatz | **bordbar_new** in a customized design



Reference: Zahnarzt am Rudolfplatz | **bordbar_new** in a customized design

Bring It to Your World.

Die Einsatzmöglichkeiten der bordbar sind nahezu unbegrenzt – mit vielseitigen Ausstattungsvarianten für unterschiedlichste Arbeitsumgebungen.

The different ways to use your bordbar are virtually endless – with versatile equipment options for the widest range of work settings.



Our Design Service

Unser professionelles Design-Team macht aus jeder bordbar ein echtes Unikat – gestaltet nach den Ideen Ihrer Kundinnen und Kunden.

Our team of professional designers makes every bordbar truly one of a kind – designed to your customers' ideas.



Design your own bordbar!

Branding for Office and Objects

Zeit für Kreativität! Wir beraten Sie gerne, damit eine individuell gestaltete bordbar schon bald Ihr Projekt bereichert.

Time to get creative! We are on hand to help so that a customized bordbar will soon be adding that special something to your project.



**bordbar
Outdoor**





Outdoor Proofed and Stainless

Classy and Sturdy. Also Outdoors Too.

Ob bei beständiger Sonne oder Regenwetter: Die bordbar hält dank ihrer robusten Beschaffenheit aus korrosionsbeständigem Aluminium jeder Witterung stand.

Come rain or shine, thanks to its robust properties and corrosion-resistant aluminum, nothing can shake your bordbar.



Built To Last.



Jede bordbar ist gemacht, um zu halten. Feuchtigkeitsbeständig und stabil, einsatzbereit an den verschiedensten Orten drinnen und draußen.

Each bordbar is built to last. Damp-proof and sturdy, ready to go wherever you need inside and out.





**bordbar
Products**



bordbar Product Overview

Charakterstark, individuell und einzigartig: Jede bordbar ist ein Unikat, das höchste Designansprüche erfüllt. Sie vereint 250 Einzelelemente in einer Symbiose aus ästhetischem Design und gekonnter Funktionalität. Ganz nach Luftfahrt-Vorbild und bereit für die Bodenmission.

Oodles of personality, custom-built and one-of-a-kind. Every bordbar is a unique piece that satisfies the highest design standards. 250 individual elements combined into a symbiosis of aesthetic design and ingenious functionality. Just like its airborne counterpart. Ready for its ground mission.

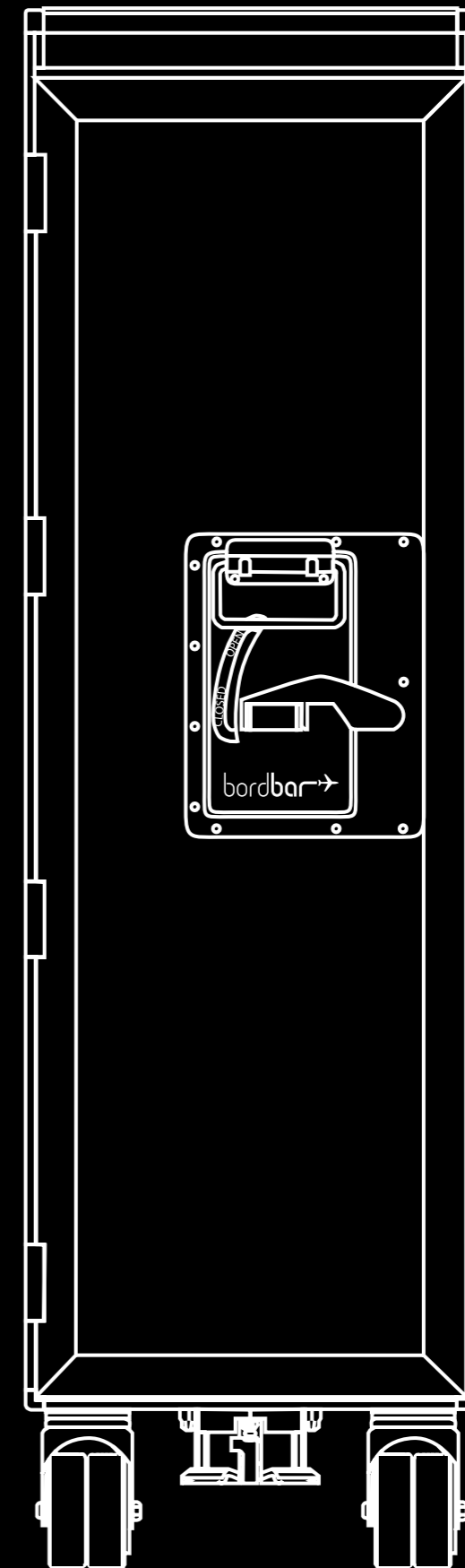

Trolleys



bordbar_new

Jede bordbar ist so einzigartig wie Ihre Projekte. Die nahezu grenzenlosen Kombinationsmöglichkeiten aus Design, Farbe und Ausstattung sorgen dafür, dass sich die bordbar_new mühelos in jede Umgebung einfügt.

Our bordbars are as unique as your projects. The almost endless possibilities for combining different designs, colors and fittings ensure our bordbar_new fits effortlessly into any surroundings.



bordbar_black

Puristisch und außergewöhnlich: die bordbar_black besticht mit einer markanten Optik. Ein schwarz eloxierter Aluminiumkorpus sowie eine pulverbeschichtete, schwarze Schlossplatte machen sie zum Inbegriff funktionalen Designs.

Purists will love the bordbar_black's distinctive visuals and exceptional design. The black anodized aluminum body, powder-coated black lock plate make our bordbar_black the epitome of functional design.



rivet rocker_new

Inspiziert von Luftfahrtlegenden wie der DC-3, steht der rivet rocker_new für pure handwerkliche Substanz: Polierter Edelstahl, silbereloxierte Rahmen und über 400 Nieten verleihen ihm einen unvergleichlichen Charakter.

Inspired by aviation legends such as the DC-3, the rivet rocker_new stands for consummate craftsmanship. The combination of polished stainless-steel, silver anodized frames and over 400 rivets give this edition its unique character.



rivet rocker_black

Ein Klassiker, der nach Neuem strebt: Der rivet rocker_black kombiniert legendären Flugsgeist mit durchdachter Funktionalität und zeitlosem Schwarz. Sein charmanter Retro-Look lässt ihn gleichermaßen edel und rustikal wirken.

A timeless classic breaking new ground: The rivet rocker_black combines legendary aviation spirit with ingenious functionality and timeless black. Its charming retro look lends it an air of sophistication and ruggedness all at once.

bordbar_box

Als wäre sie direkt von der Flugzeug-Galley zur Bodenmission gestartet: Die bordbar_box ist genauso authentisch wie ihre Kollegen aus den Airline-Bordküchen. Mit zeitlosem Design und durchdachter Funktionalität eröffnet die bordbar_box unzählige Einsatzmöglichkeiten – individuell konfigurierbar mit einer Vielzahl an Zubehör.



Looking like it stepped straight off the plane galley to report for its new ground mission: the bordbar_box is just as authentic as its counterparts that grace airline galleys. Its timeless design and ingenious functionality make the bordbar_box a flexible piece of design furniture with countless possible uses. Its wide range of equipment add-ons mean you can configure it to your individual needs.



bordbar_hightable

First class upgrade: Der bordbar_hightable macht als Steharbeitsplatz, Meetingpoint oder einladender Bartisch immer eine gute Figur. Er lässt sich mit einem Handgriff an jeden bordbar Trolley montieren und kommt ohne weiteres Befestigungsmaterial aus. Exklusive Tischplatten der deutschen Manufaktur JANUA setzen zusätzlich ein elegantes Statement.

First class upgrade: as a stand-up desk, meeting point or an inviting bar table, the bordbar_hightable is always a stunning addition. It can be attached to any bordbar Trolley in one simple step without the need for any additional fixings. Exclusive tabletops crafted by the German manufactory JANUA ensure you an elegant statement piece for any interior.



Overview All Product Lines

Immer wandelbar und einsatzbereit: Es gibt für jedes Projekt und jede Umgebung eine individuell konfigurierte bordbar, eine bordbar_box oder einen bordbar_hightable.

Always versatile and ready to go: For every project and every setting there is a bordbar, bordbar_box or a bordbar_hightable you can configure individually.

Trolleys | Korpusvarianten



bordbar_new



bordbar_black



rivet rocker_new



rivet rocker_black

Box



bordbar_box

Trolleys | Upgrade Hightable



bordbar_hightable

Imprint



bordbar design GmbH
Daimlerstraße 21
50859 Cologne, Germany

T: +49 (0)221 70 90 50-0
F: +49 (0)221 70 90 50-11

bordbar.de
cockpit@bordbar.de

CEO
Stephan Boltz

Die Abbildungen entsprechen dem aktuellen Stand zum Zeitpunkt der Drucklegung. Änderungen der Maße, Materialien und der Funktion, die auf technische Weiterentwicklung zurückzuführen sind, bleiben vorbehalten. Irrtümer vorbehalten.

Photographs are up to date to time of printing. We reserve the rights to make change to dimension, material and function as a result of contuse developments. Errors excepted.



Sie benötigen 3D-Daten für die Planung Ihres Projekts? Kontaktieren Sie uns – wir stellen sie Ihnen gerne zur Verfügung.

Please feel free to contact us if you need 3D data to plan your project.