

AZ1
ARMCHAIR

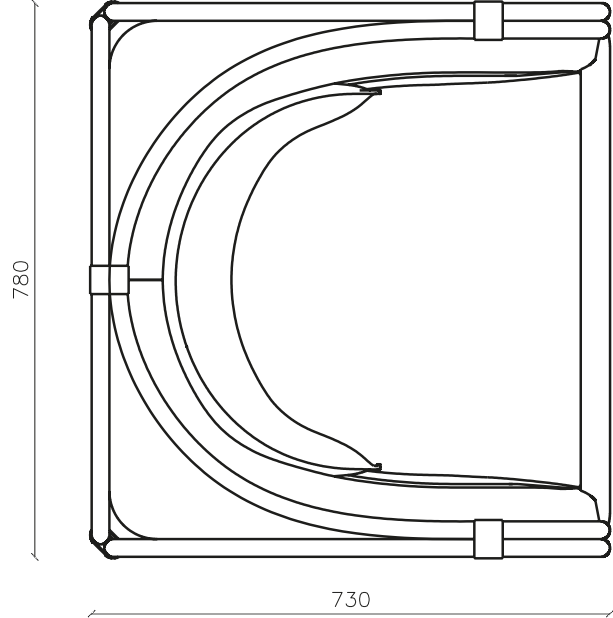

AZ1
ARMCHAIR

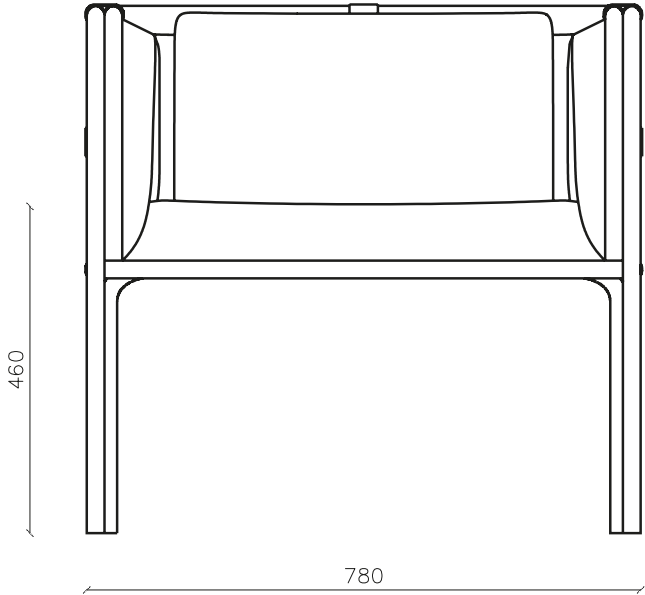
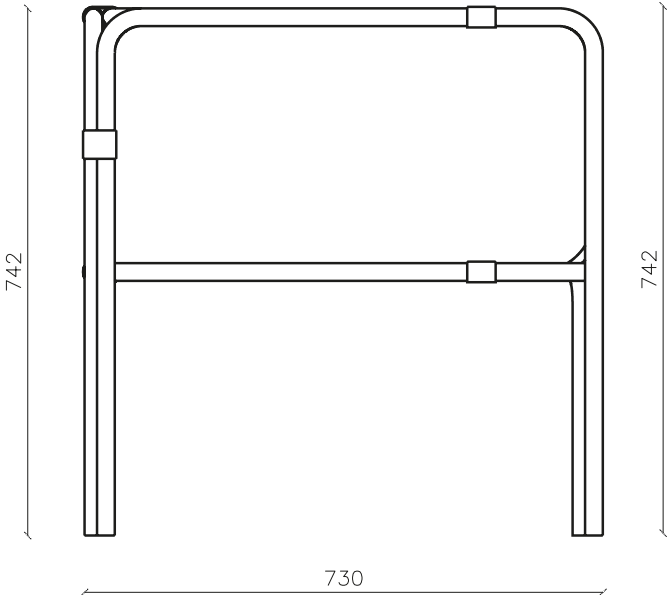

AZ1 ARMCHAIR

W 75 cm | 30"

D 70 cm | 27"

H 73 cm | 29"

SH 46 cm | 18"

PRODUCT FEATURES

Black Lacquered Metal frame structure.

Upholstered in leather.

PRODUCT OPTIONS

UPHOLSTERY:

Available in all COLLECTOR leathers and fabrics.

Available in client's own material.

METAL FINISHES:

Available in all RAL colors.

BETREND FABRIC

TECHNICAL DETAILS

Composition: 53.3% AC + 46.7% PL

Width: 140cm

Weight: 653,8 g/m

Martindale: >50.000

Use



Washing Conditions

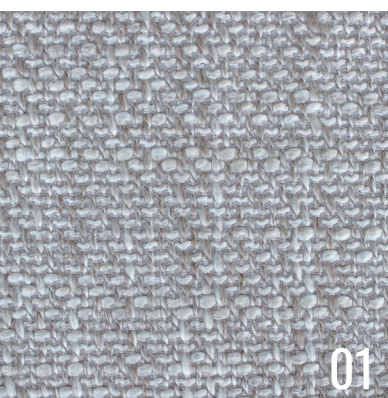

01



02



03

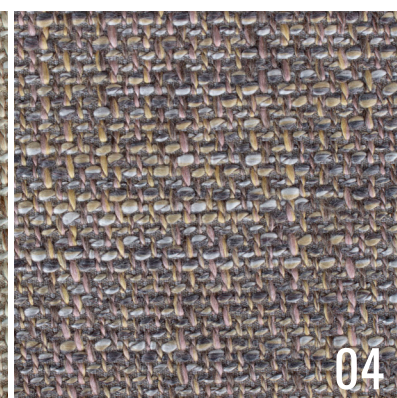

04

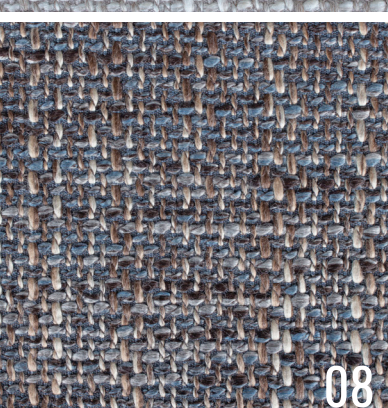

08

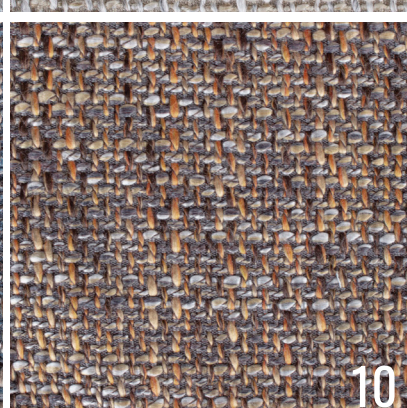

10

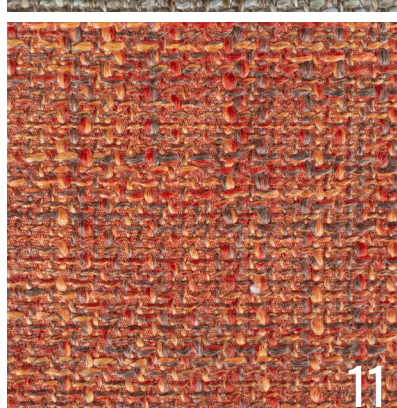

11

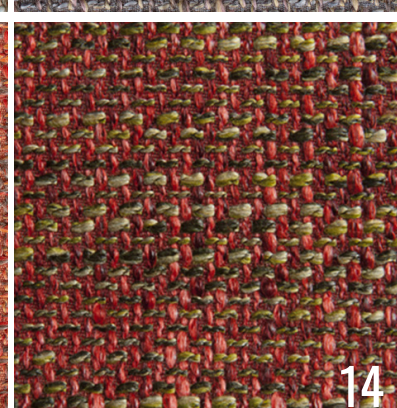

14

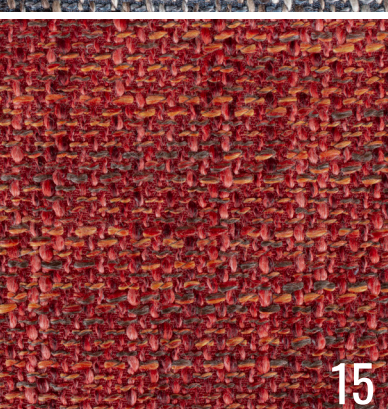

15



16

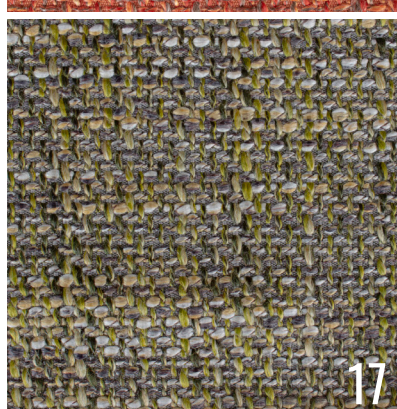

17



18

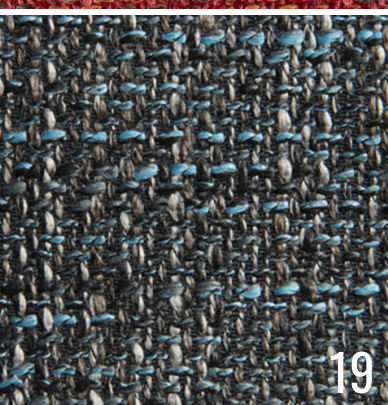

19

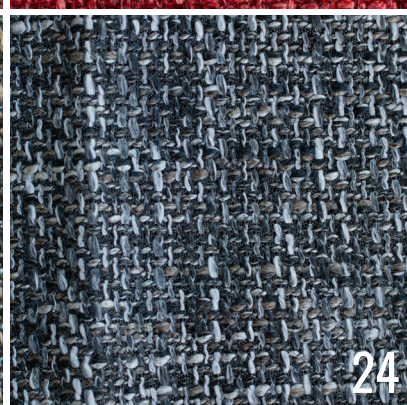

24

COLLECTOR

www.collectorgroup.pt

The right to discontinue and make changes is reserved.
The colors shown here are merely representative, they may suffer variations.

FAMIGLIA FABRIC

TECHNICAL DETAILS

Composition: 85%PES + 15%CO
Width: 140cm
Weight: 700 g/ml
Martindale: 30.000

Use



Washing Conditions

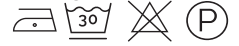

COLLECTOR

www.collectorgroup.pt

The right to discontinue and make changes is reserved.
The colors shown here are merely representative, they may suffer variations.

SIEGE FABRIC

TECHNICAL DETAILS

Composition: 100% CO
Width: 140cm
Weight: 560 g/m
Martindale: 40.000
Lightfastness: 4

Use



Washing Conditions



Biege



Linen



Taupe



Ivory



Pure Yellow



Hot Coral



Rubi



Syrah



Chocolat



Navy Blue

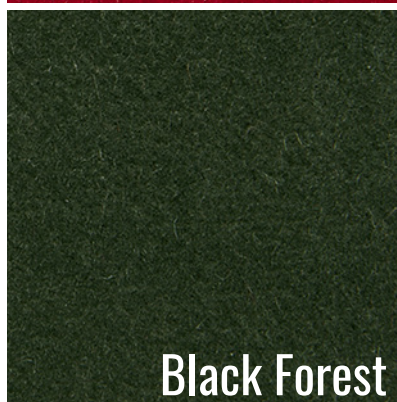

Black Forest

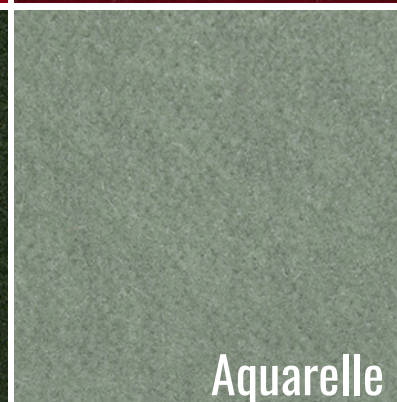

Aquarelle



Steal



Horizon Blue

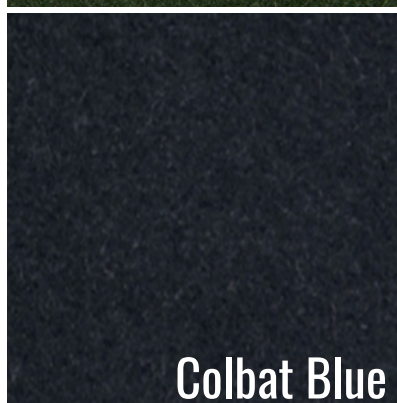

Colbat Blue



Safari Green

COLLECTOR

www.collectorgroup.pt

The right to discontinue and make changes is reserved.
The colors shown here are merely representative, they may suffer variations.

TULU FABRIC

TECHNICAL DETAILS

Composition: 53.70% AC + 46.30% PL

Width: 140cm

Weight: 588 g/ml

Martindale: > 70.000

Lightfastness: 3-4

Pilling: 4-5

FR: Available in 2 versions BS 5852-1:1979

SOURCE 0 CIGARRET / 1 MATCH

Use



Washing Conditions

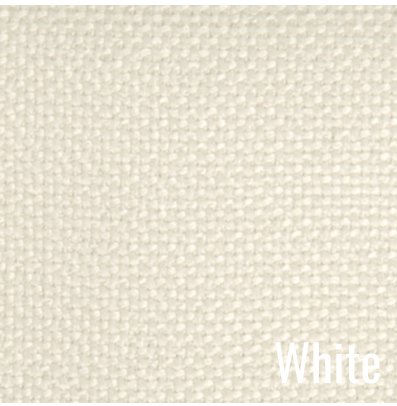

White



Prairie Sunset



Timber Wolf



Brown



Fall Leaf



Drie Moss

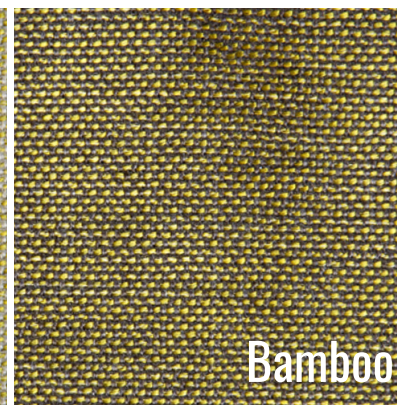

Bamboo

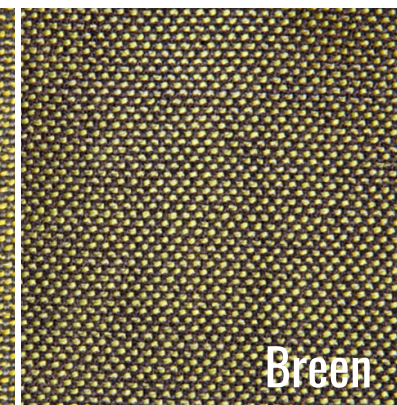

Green

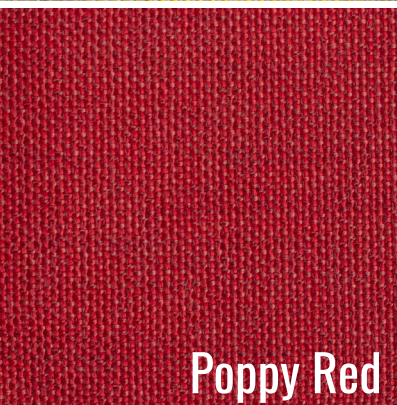

Poppy Red

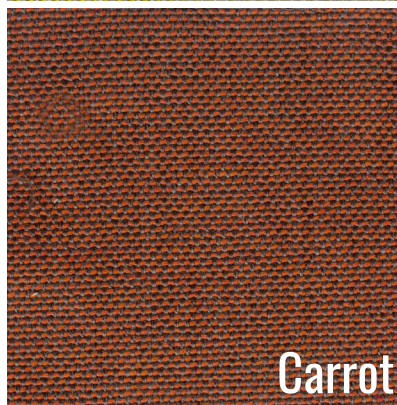

Carrot

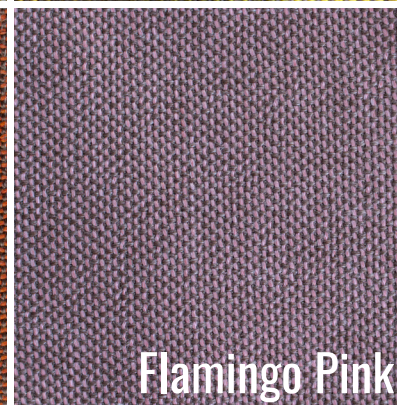

Flamingo Pink



Beach Glass



Brown Viridiam



Kangaroo



Coffee Bean



Dark Brown

COLLECTOR

www.collectorgroup.pt

The right to discontinue and make changes is reserved.
The colors shown here are merely representative, they may suffer variations.

BOHO FABRIC

TECHNICAL DETAILS

Composition: 84% PL + 16% AC

Width: 140cm

Weight: 900 g/ml

Martindale: > 45.000 CC

Use



Washing Conditions



Creamy



Natural Raffia

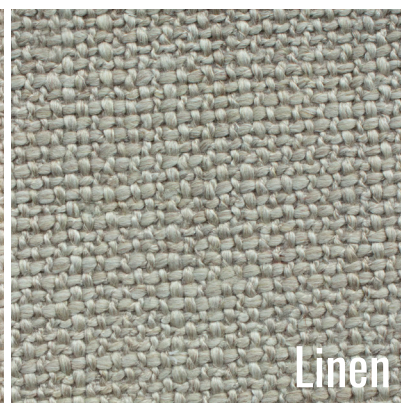

Linen

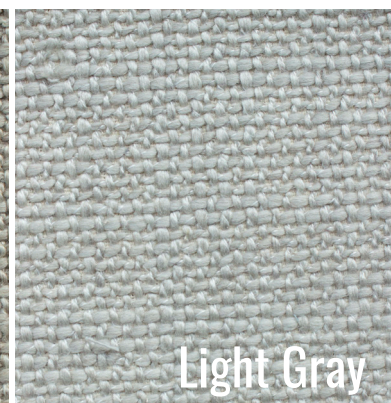

Light Gray



Warm Gray

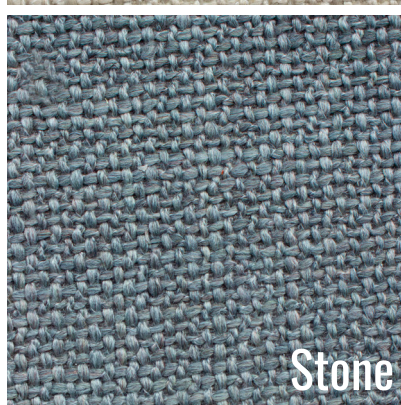

Stone

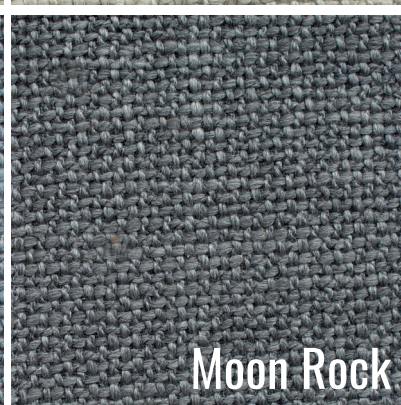

Moon Rock

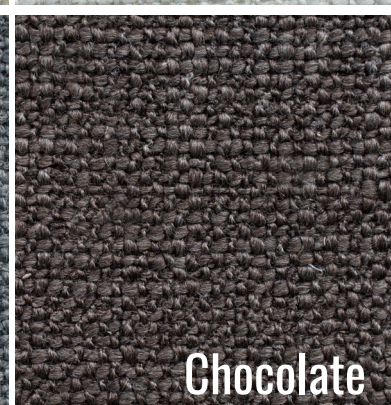

Chocolate



Golden Ocre

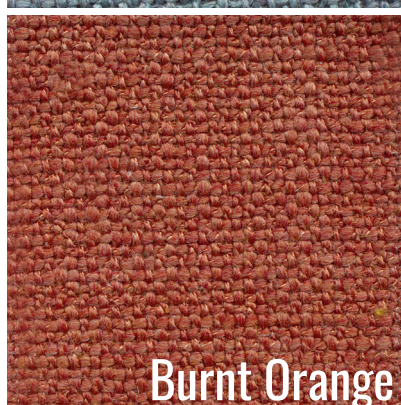

Burnt Orange



Bordeaux

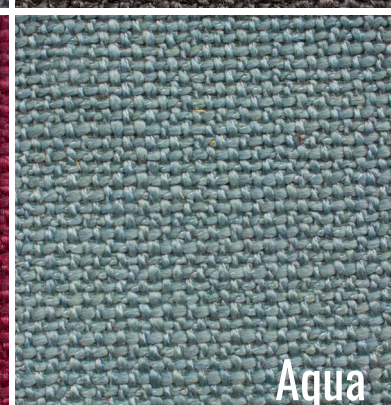

Aqua



Artic Blue



Cobalt blue

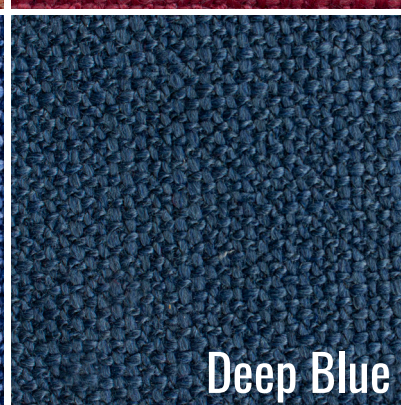

Deep Blue

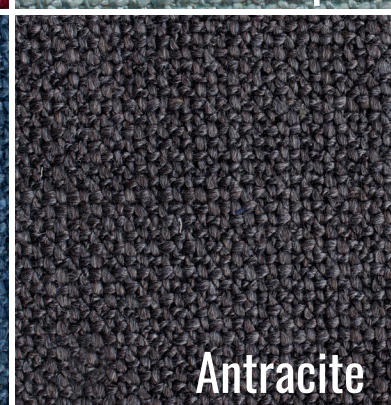

Antracite

COLLECTOR

www.collectorgroup.pt

The right to discontinue and make changes is reserved.
The colors shown here are merely representative, they may suffer variations.

ZUMIREZ

FABRIC *PREMIUM*

TECHNICAL DETAILS

Composition: 68% WO 19% CO 13% PL
Width: 136cm
RUB TEST: 40.000
Type: Textured Weave

Use



Washing Conditions



Moonbeam



Umber



Tabacco

BOUCLE

FABRIC *PREMIUM*

TECHNICAL DETAILS

Composition: 96%PI 4%A

Width: 140cm

Weight: 680gr/m

Use



Washing Conditions



White

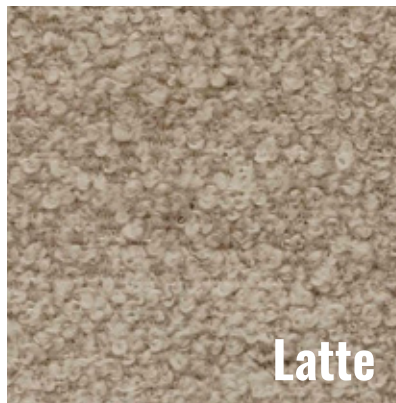

Latte

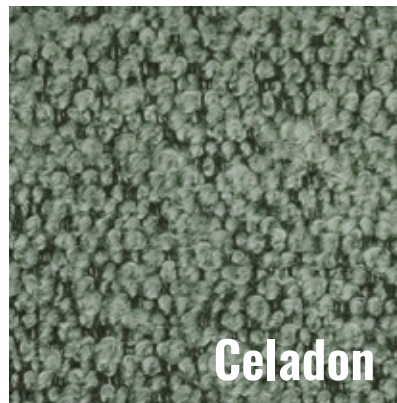

Celadon

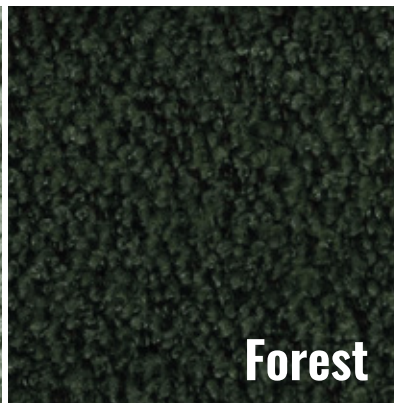

Forest



Gold

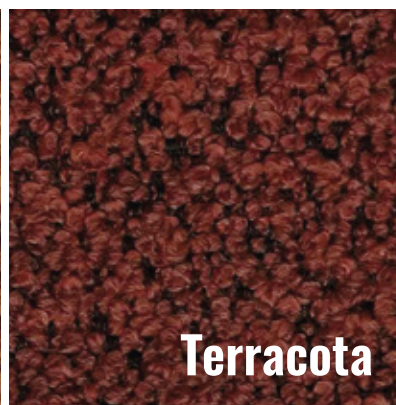

Terracota