

TONONE

technical specifications

BRIDGE 110

Design by Anton de Groof, 2023

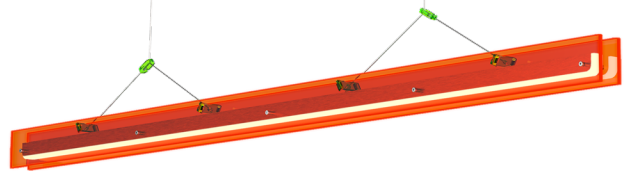

A striking design that distinguishes itself from the current collection by a striking choice of materials. Nevertheless, with the Tonone signature, bold & functional. A lamp that allows for a graphic interplay of lines and with which you can experiment with composition. Inspired by the construction of a bridge, Bridge has different supports, so the load-bearing capacity is evenly distributed along its length. You don't have a power cable that catches the eye. That's because the power is conducted by steel cables, which are also used to hang the lamp. The lamp is made of recycled plexiglass and available in neon colors in addition to an opal color. The transparency of the material creates an interesting layering and impressive light output. The lamp is available in different lengths; 110, 150, 180 to 220 cm.

Type	Pendant lamp
Environment	Indoor
Material	Aluminum, acryl & steel
Cord length	3000 mm
Weight	1,9 kg

Voltage	220–240 V
Watt	15 Watt
IP	20
Lightsource	Integrated LED source
Lumen	1492
Kelvin	2700K
CRI	90
Dimmable	Mains dimmable

Packaging	
Weight	3 kg
Length	1200 cm
Width	130 cm
Height	130 cm

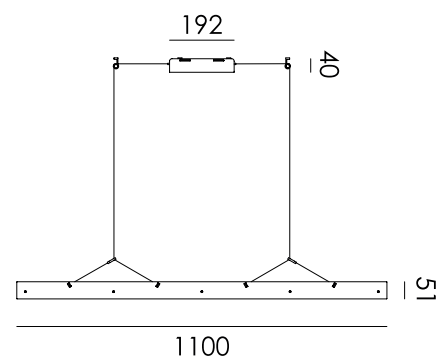

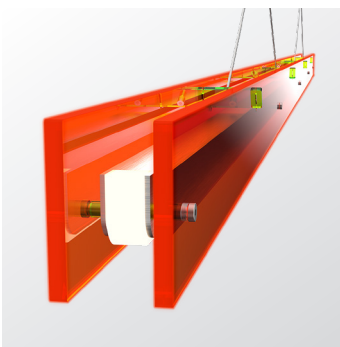
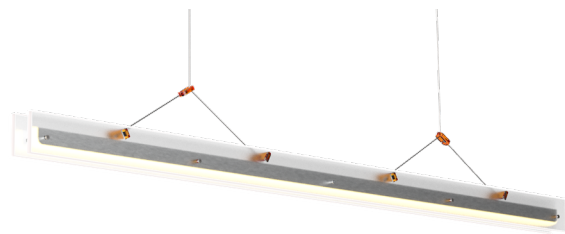
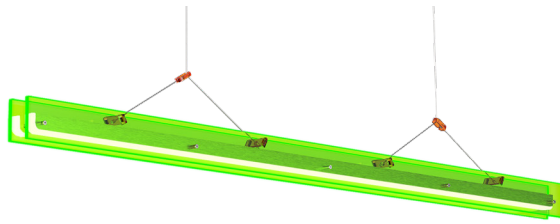
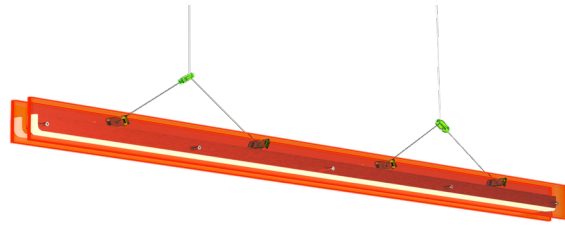

TONONE

technical specifications



Article number

	fog white	6002
	lava orange	6000
	toxic green	6001