

TONONE

technical specifications

BOLT bed under fit

Design by Anton de Groof, 2013



Starting point for the products of Tonone is the passion for traditional mechanics. The first product line that resulted from this fascination is the lamp series 'Bolt'. Key element in this industrial series is the joint construction that can be adjusted with a wingnut-shaped tool. Besides being a functional tool, this wingnut is integrated in the design of the lamp itself as a distinctive visual element. The Bolt collection is available in 29 different models and in 10 colors.

Type	Bed lamp
Environment	Indoor
Material	Steel & aluminum
Wingnut	Wingnut Solid Brass included
Cord length	Bolt with cord 2500 mm Bolt install 10 mm
Weight	1,4 kg
Voltage	220-240 V
Max Watt	60 Watt
Socket	E27
IP	20
Lightsource	Lightsource not included

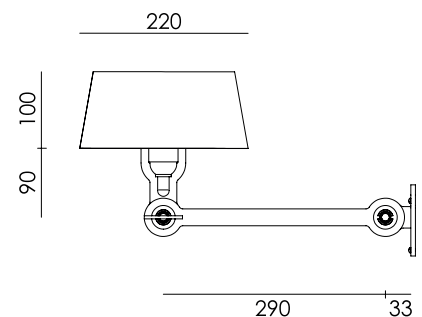

Packaging



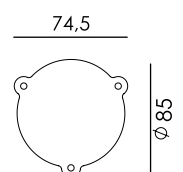







Weight	3,6 kg
Length	75 cm
Width	47 cm
Height	25 cm



TONONE

technical specifications



		with cord	install	mirror with cord	mirror install
	smokey black	1145	1153	1519	1376
	flux green	1147	1155	1520	1377
	pure white	1149	1157	1521	1379
	midnight grey	1272	1273	1522	1383
	ash grey	1152	1160	1523	1382
	striking orange	1150	1158	1524	1380
	lightning white	1148	1156	1525	1378
	thunder blue	1151	1159	1526	1373
	daybreak rose	1481	1482	1527	1483
	sunny yellow	1439	1440	1528	1441

TONONE

technical specifications

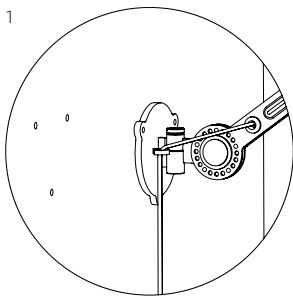
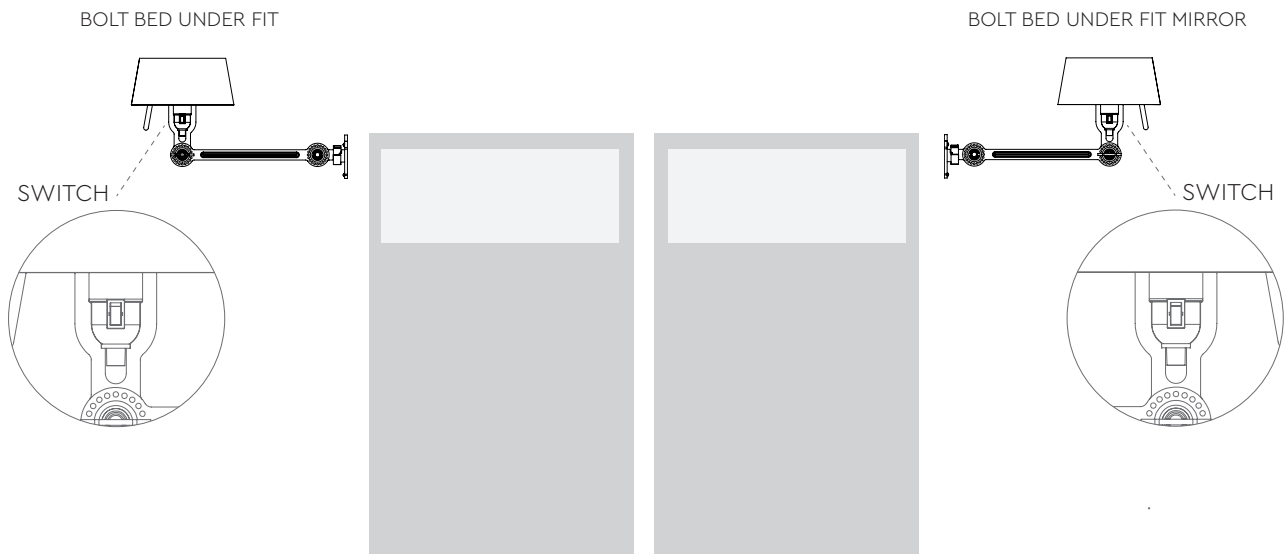

With cord

1. With powercord including switch and plug.

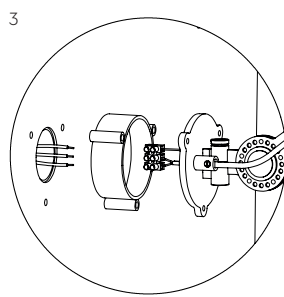
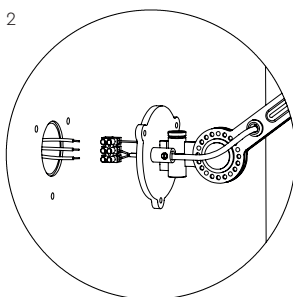

Install

2. With terminal block to install directly on a junction box.

3. With optional wall ring.