

TONONE

technical specifications

BOLT bed side fit

Design by Anton de Groof, 2013



Starting point for the products of Tonone is the passion for traditional mechanics. The first product line that resulted from this fascination is the lamp series 'Bolt'. Key element in this industrial series is the joint construction that can be adjusted with a wingnut-shaped tool. Besides being a functional tool, this wingnut is integrated in the design of the lamp itself as a distinctive visual element. The Bolt collection is available in 29 different models and in 10 colors.

Type	Bed lamp
Environment	Indoor
Material	Steel & aluminum
Wingnut	Wingnut Solid Brass included
Cord length	Bolt with cord 2500 mm Bolt install 10 mm
Weight	1,2 kg
Voltage	220-240 V
Max Watt	60 Watt
Socket	E27
IP	20
Lightsource	Lightsource not included

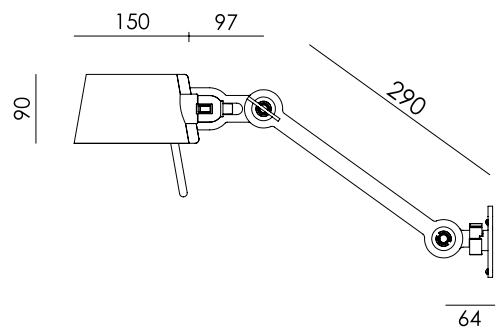

Packaging



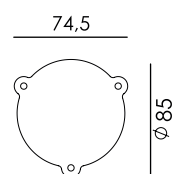







Weight	2,0 kg
Length	67 cm
Width	20 cm
Height	20 cm



TONONE

technical specifications



		with cord	install	mirror with cord	mirror install
	smokey black	1129	1137	1509	1368
	flux green	1131	1139	1510	1369
	pure white	1133	1141	1511	1371
	midnight grey	1270	1271	1512	1375
	ash grey	1136	1144	1513	1374
	striking orange	1134	1142	1514	1372
	lightning white	1132	1140	1515	1370
	thunder blue	1135	1143	1516	1373
	daybreak rose	1478	1479	1517	1480
	sunny yellow	1436	1437	1518	1438

TONONE

technical specifications

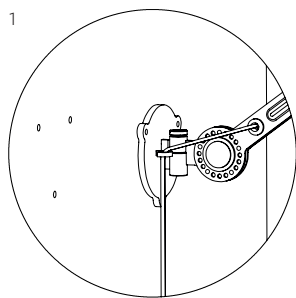
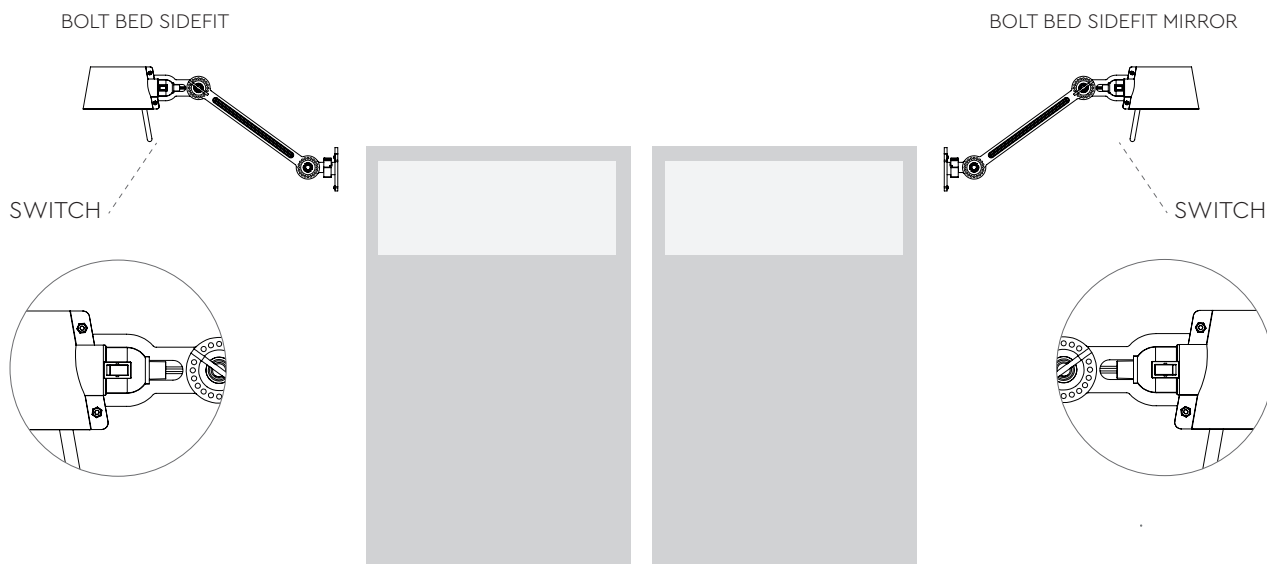

With cord

1. With powercord including switch and plug.

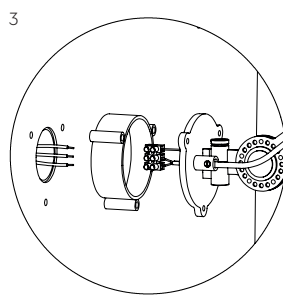
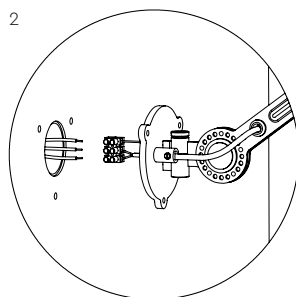

Install

2. With terminal block to install directly on a junction box.
3. With optional wall ring.