

MATHENY XL | WALL

Matheny wall light has a complex and attractive geometry design of combined tubes. This unique lamp combines a mid-century modern design with a classic style that will make a statement in your home.

Providing a subtle glow, this modern wall light is 100% handmade in brass and has a brushed nickel finish.

With 6 lamps, we recommend you to use G9 bulbs. Ideal for your industrial kitchen or to use as a bedside reading lamp, Matheny wall light will add a smooth lighting effect to every single room of your interior design.

MATERIALS

BODY: Brass

STANDARD FINISHES*

BODY: Brushed Nickel



Aged Brass Black Lacquered Brushed Nickel Copper Plated Nickel Plated

*MORE FINISHES AVAILABLE IN P.247 | 248

WEIGHT

Approx. 5 kg | 11 lbs

BULBS

6 x G9 Halogen Bulbs 28W (included)
(bulbs not included for North America)

DIMENSIONS

WIDTH: 9" | 23 cm

HEIGHT: 31,4" | 80 cm

DEPTH: 5,11" | 13 cm

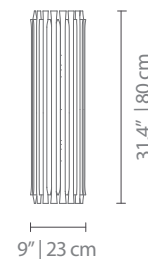

ALSO AVAILABLE IN CATALOG 2018

MATHENY | SUSPENSION P.86; MATHENY | PENDANT P.88; MATHENY | FLOOR P.136;
MATHENY | TABLE P.182; MATHENY | WALL P.222.

For more information, contact our team.

INFO@DELIGHTFULL.EU | WWW.DELIGHTFULL.EU

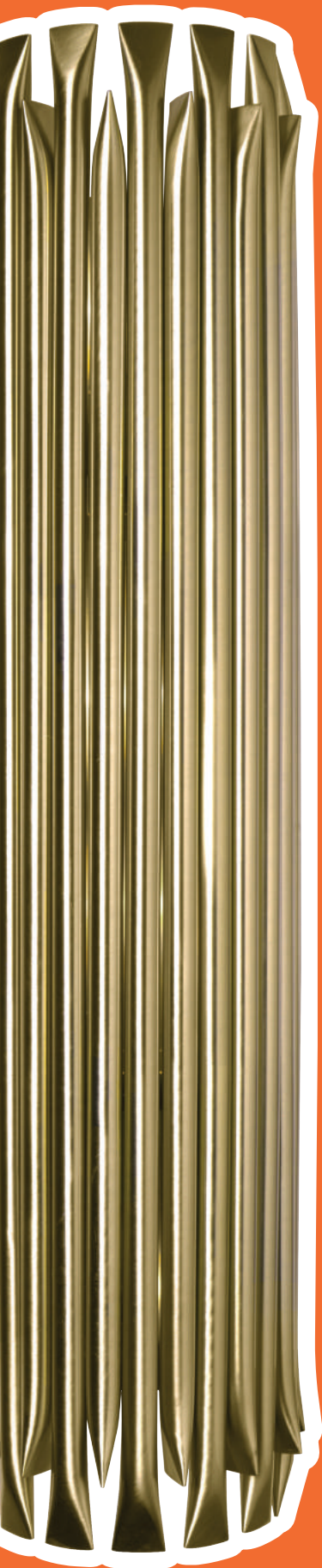

MATHENY XL | WALL

PACKAGE

(Cardboard Box)

WIDTH: 32,6" | 83 cm

HEIGHT: 12,9" | 33 cm

DEPTH: 12,9" | 33 cm

PACKAGE VOLUME: 0.09 m³

WEIGHT: Approx. 12 kg | 26.4 lbs

BULBS

6 x G9 Halogen Bulbs 28W (included)

OPTIONAL BULBS

6 x G9 Led Bulbs 3W (customizable on purchase)

BULB STANDARD

LIGHT TECHNOLOGY: Halogen

POWER: 28W

LUMENS: 350LM

COLOUR TEMPERATURE: 2700K

BULB OPTIONAL

LIGHT TECHNOLOGY: Led

POWER: 3W

LUMENS: 240LM

COLOUR TEMPERATURE: 2700K

CANOPY AND SHADE

DESCRIPTION

CANOPY

SHADES

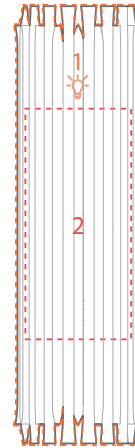

CANOPY

Nº2 - 1 unit

WIDTH: 7" | 18 cm

HEIGHT: 17,3" | 44 cm

DEPTH: 0,98" | 2,5 cm

SHADES

Nº1 - 1 unit

WIDTH: 9" | 23 cm

HEIGHT: 31,4" | 80 cm

DEPTH: 5,03" | 12,8 cm

Shade with bulb 

For more information, contact our team.

INFO@DELIGHTFULL.EU | WWW.DELIGHTFULL.EU

MATHENY XL | WALL

ASSEMBLY SCHEME* 
INSTRUCTIONS

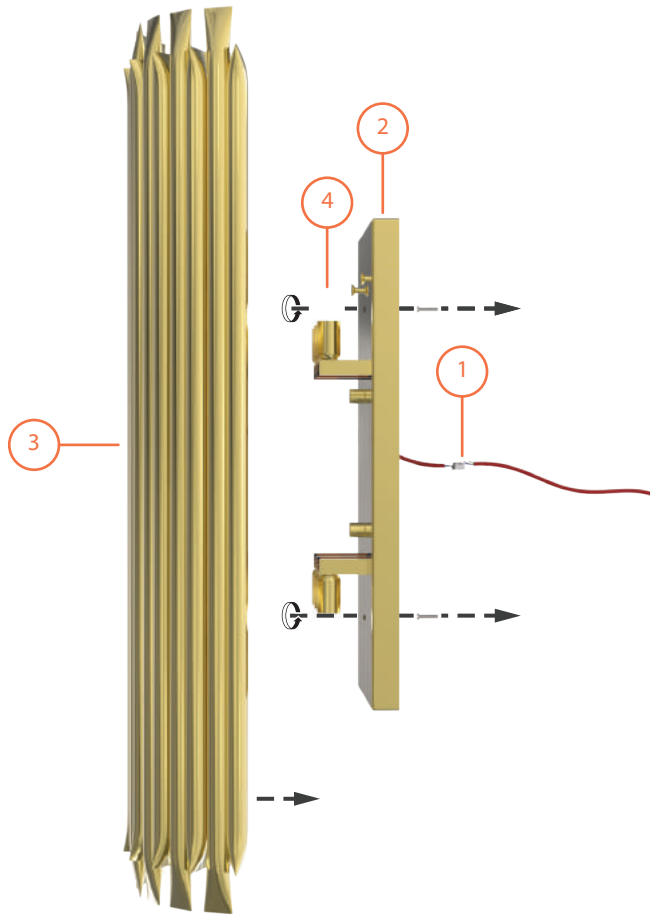

STEP 1
ELECTRICAL CABLE CONNECTIONS

STEP 2
SET THE SUPPORT ON THE WALL

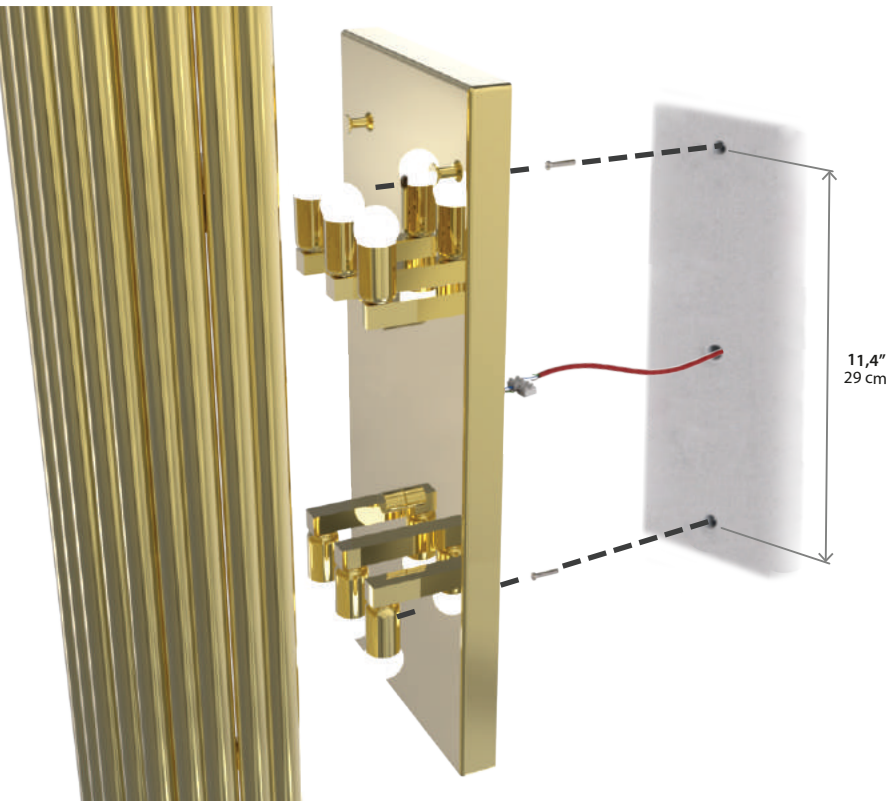

STEP 3
PLACE MATHENY XL ON THE CENTER OF
THE WALL SUPPORT

STEP 4
INSERT THE BULBS

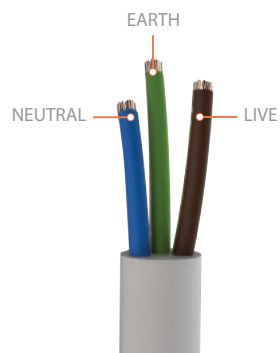

ELECTRICAL CABLE 
INFORMATION



2UNI   6UNI 
SCREWS BULBS

DISPOSAL 
For all products that are damaged, find professional help.

 CERTIFICATE

For more information, contact our team.
INFO@DELIGHTFULL.EU | WWW.DELIGHTFULL.EU