



nomon
JEWELRY FOR HOME

TOCADOR
VANITY TABLE

TOCADOR

VANITY TABLE

nomon
JEWELRY FOR HOME

Este producto está inspirado en una mujer sensible y actual, hemos cuidado la suavidad de las formas y materiales sin olvidar la funcionalidad.

Es un homenaje a las mujeres femeninas y coquetas. Nos evoca recuerdos de la infancia, mientras observávamos admirados a nuestras madres maquillándose.

This product is inspired by a sensible, modern woman; without forgetting functionality, we have given care to softness in shapes and materials.

It's a tribute to feminine and flirty women. It evokes memories of our childhood, while we were admired looking our mothers putting on their make-up.

MATERIALES

MATERIALS

Nogal natural macizo o fresno teñido negro y detalles de latón pulido.

Sobre de mármol opcional.

Puf tapizado en terciopelo color rosa, gris o beige.

Natural solid walnut or black ash and polished brass accessory.

Optional marble top.

Pouf upholstered in pink, grey or beige velvet.

OPCIONES MADERA

WOOD OPTIONS

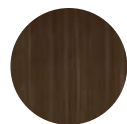

Nogal
Walnut

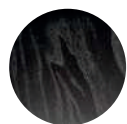

Fresno teñido negro
Black ash

OPCIONES MÁRMOL

MARBLE OPTIONS

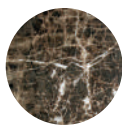

Emperador

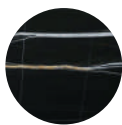

Sahara Noir



Calacatta Gold

ACABADOS PUF

PUF FINISHES



Beige
Beige



Rosa
Pink



Gris
Grey

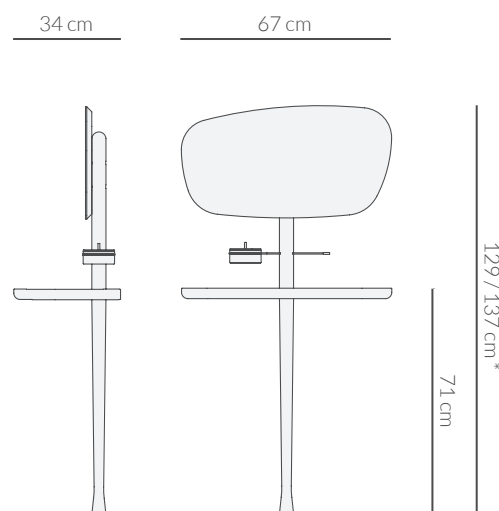

* El espejo puede ajustarse a dos alturas.
* The mirror can be adjusted in two heights.

* Posibilidad de usar tela cliente.
* Possibility to use client fabric.

Dimensiones de la tela: 1,40m de ancho por 1,80m de largo para 1 y 2 pufs.
Fabric dimensions: 1,40m wide by 1,80m long for 1 and 2 pufs.

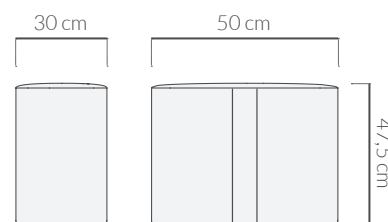

PACKAGING

Peso / con mármol: 12,0 kg/19,5 kg

Dimensions (cm): 54x95x13

Volumetric weight: 13,3 kg

Weight / with marble: 12,0kg/19,5kg

Dimensions (cm): 54x95x13

Volumetric weight: 13,3 kg

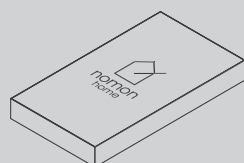

Peso: 10,2 kg

Dimensions (cm): 39x61x50

Volumetric weight: 28,3 kg

Weight: 10,2kg

Dimensions (cm): 39x61x50

Volumetric weight: 28,3 kg

