

TECHNICAL SPECIFICATION

Dreams Cabinet

Cristian Zuzunaga
2015



COMPONENTS, MATERIALS & FINISHES:

Containers and doors manufactured in MDF fiber board in different thickness in matt lacquered. The containers are fixed between them through mechanical system.

Tops, doors and side in 6mm tempered glass printed. The impression is always on the inside, protected with a layer of white paint.

legs solid beech legs lacquered matt. Regulator plug mated at the bottom.

Opening system embedded hinges and touch-touch system.

Drawers full extension guides with integrated cushioning.

Maximum load weight of 30Kg / 66lbs.

Containers, doors and legs are finished in matt black.

Glass printed in three patterns proposed by designer: color, white-black and all black.

DIMENSIONS & WEIGHT:

Model 2M (not accessories): 201x51x66cm - 121Kg

79"x20"x26" - 267lbs

Model 3M (not accessories): 301x51x66cm - 178Kg

118"x20"x26" - 392lbs

Shelf accessory: 2,8Kg / 6lbs

Drawer + Shelf accessory: 10,7Kg / 24lbs

PACKAGING:

All models are shipped disassembled for parts: each module in a cardboard box reinforced with wooden box.

CLEANING & MAINTENANCE

The table should be cleaned with a damp cloth or a mild soap, recommended to use green baize. Do not use cleaning products with alcohols and solvents or their derivatives.

MAXIMUM LOAD OF WEIGHT

The maximum weight we can load on the top of the cabinet: 40kg/ 88lbs distributed weight

The maximum weight we can load on each 50cm/19,7" shelf (30Kg 66lbs distributed weight)

TESTS

Fixing the glass it is certified under the UNE 48025:1979 - static shear load - hot - cold cycles (COLD-CHECK)

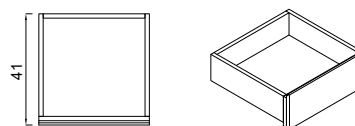
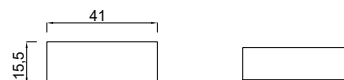
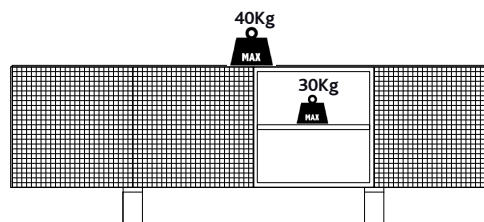
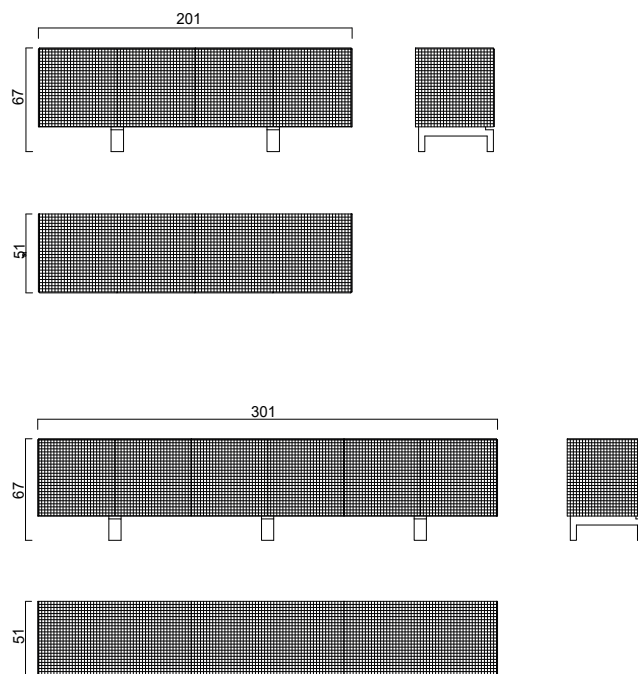

MEASUREMENTS IN CM and INCHES



Bd Barcelona design

Ramon Turró, 126 / 08005 Barcelona

Tel +34 93 458 69 09 / Fax +34 93 207 36 97

bd@bdbarcelona.com / www.bdbarcelona.com

Technical department

Carretera Capellades / km 22,750

Narcís Monturiol, 7 / Pol. Ind Sesrovires

Sant Esteve de Sesrovires / 08635 Barcelona

Tel +34 93 771 30 51

HEIGHT ADJUSTMENTS

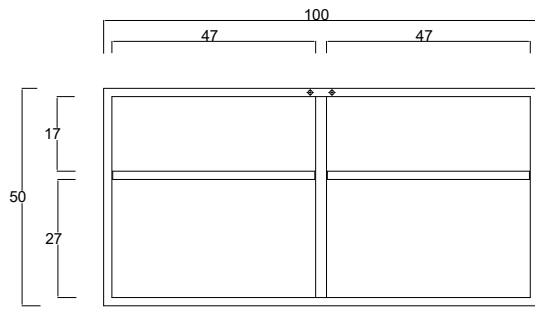

DREAMS with 2 shelves

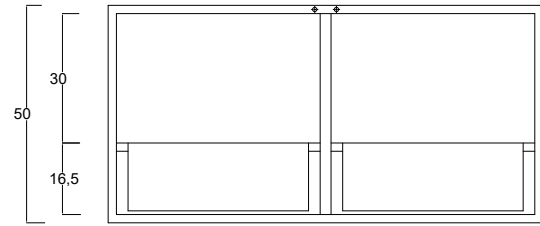

DREAMS with 2 drawers

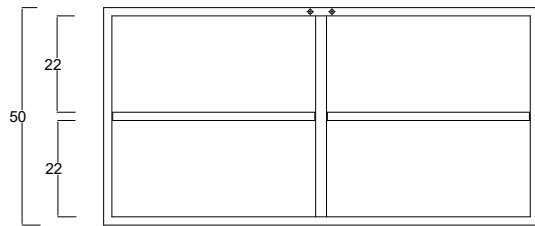

DREAMS with 2 shelves

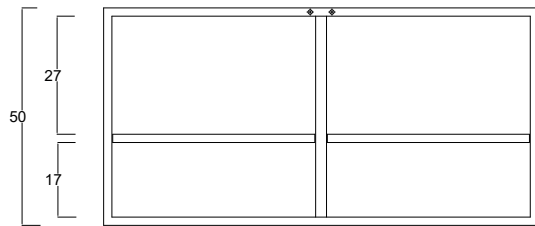

DREAMS with 2 shelves

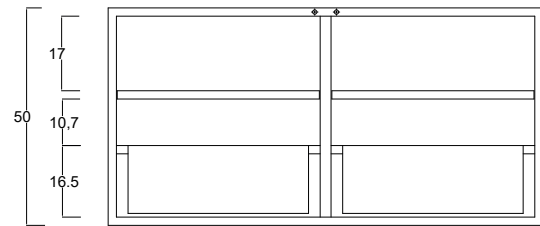

DREAMS with 2 drawers and 2 extra shelves



Bd Barcelona design

Ramon Turró, 126 / 08005 Barcelona
Tel +34 93 458 69 09 / Fax +34 93 207 36 97
bd@bdbarcelona.com / www.bdbarcelona.com

Technical department

Carretera Capellades / km 22,750
Narcís Monturiol, 7 / Pol. Ind Sesrovires
Sant Esteve de Sesrovires / 08635 Barcelona
Tel +34 93 771 30 51

FICHA TÉCNICA

Dreams Cabinet

Cristian Zuzunaga
2015

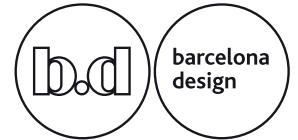

COMPONENTES, MATERIALES Y ACABADOS:

Contenedores y puertas fabricados en tablero de fibra MDF en diferentes espesores en lacado mate. Los contenedores se fijan entre ellos mediante un sistema mecánico.

Tapas, puertas y laterales en vidrio templado de 6 mm impreso. La impresión está siempre en el interior, protegida con una capa de pintura blanca.

patas de haya maciza patas lacadas mate. Enchufe del regulador acoplado en la parte inferior.

Sistema de apertura de bisagras empotradas y sistema touch-touch. Cajoneras de extensión completa con acolchado integrado. Peso máximo de carga de 30 kg / 66 libras.

Los contenedores, puertas y patas están acabados en negro mate. Vidrio impreso en tres patrones propuestos por el diseñador: color, blanco-negro y todo negro.

DIMENSIONES Y PESOS:

Modelo 2M (no accesorios): 201x51x66cm - 121Kg
79 "x20" x26 " - 267 libras

Modelo 3M (no accesorios): 301x51x66cm - 178Kg
118 "x20" x26 " - 392 libras

Accesorio de repisa: 2,8Kg / 6lbs

Accesorio Cajón + Balda: 10,7Kg / 24lbs

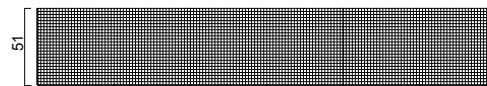
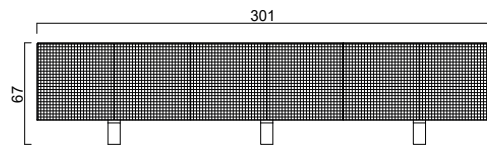
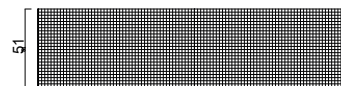
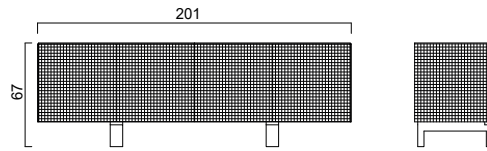

EMBALAJE:

Todos los modelos se envían desmontados para las piezas: cada módulo en una caja de cartón reforzada con caja de madera.

LIMPIEZA Y MANTENIMIENTO

La mesa debe limpiarse con un paño húmedo o un jabón suave, se recomienda usar tapete verde. No utilice productos de limpieza con alcoholes y disolventes o sus derivados.

CARGA MÁXIMA DE PESO

El peso máximo que podemos cargar en la parte superior del gabinete: 40 kg / 88 lb de peso distribuido

El peso máximo que podemos cargar en cada estante de 50cm / 19,7 "(30Kg 66lbs de peso distribuido)

ENSAYOS

La fijación del vidrio está certificada bajo la **UNE 48025: 1979** - Carga de cizallamiento estático - Ciclos frío - calor (COLD-CHECK)

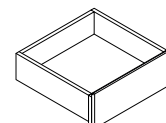
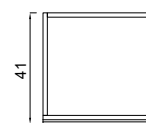
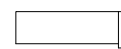
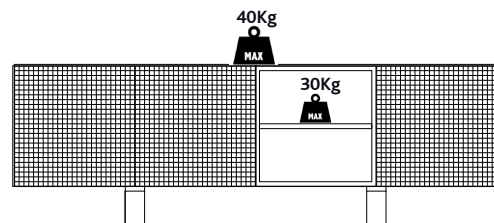

MEDIDAS EN CM y PULGADAS



Bd Barcelona design

Ramon Turró, 126 / 08005 Barcelona
Tel +34 93 458 69 09 / Fax +34 93 207 36 97
bd@bdbarcelona.com / www.bdbarcelona.com

Oficina Técnica

Carretera Capellades / km 22,750
Narcís Monturiol, 7 / Pol. Ind Sesrovires
Sant Esteve de Sesrovires / 08635 Barcelona
Tel +34 93 771 30 51

AJUSTES DE ALTURA

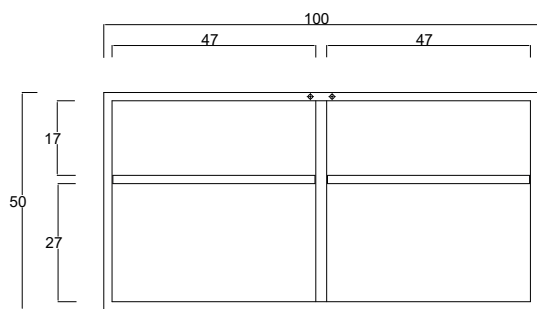

DREAMS con 2 baldas

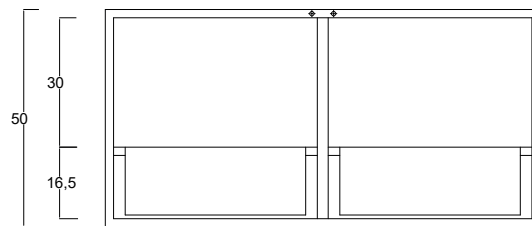

DREAMS con 2 cajones

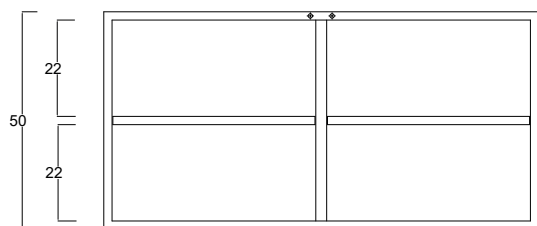

DREAMS con 2 baldas

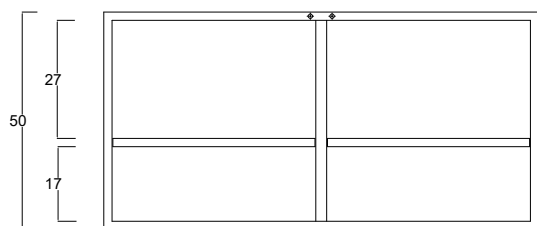

DREAMS con 2 baldas

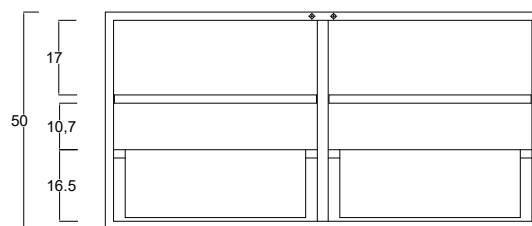

DREAMS con 2 cajones y 2 baldas externas

MEDIDAS EN CM y PULGADAS



Bd Barcelona design
Ramon Turró, 126 / 08005 Barcelona
Tel +34 93 458 69 09 / Fax +34 93 207 36 97
bd@bdbarcelona.com / www.bdbarcelona.com

Oficina Técnica
Carretera Capellades / km 22,750
Narcís Monturiol, 7 / Pol. Ind Sesrovires
Sant Esteve de Sesrovires / 08635 Barcelona
Tel +34 93 771 30 51