

# 101

## C O P E N H A G E N

DROP WALL LAMP // ASSEMBLY INSTRUCTIONS

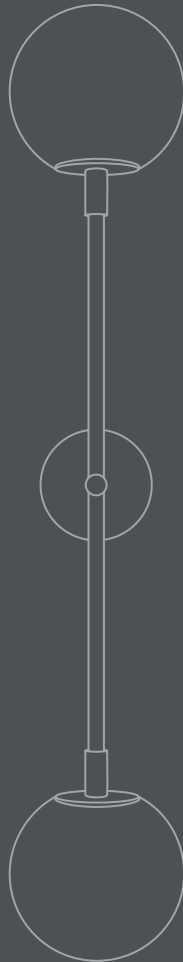



## ABOUT 101 COPENHAGEN

101 Copenhagen is a Danish design brand founded in 2017. With a vision to honor exquisite quality and craftsmanship, the collection encompasses furniture, lighting and accessories in a timeless, yet modern design. With a true passion for materials and refined textures, organic shapes and colours, 101 Copenhagen presents the epitome of classics and must-have novelties for Scandinavian and international interior connoisseurs alike.

## OUR CREATIVE DRIVE

The design of 101 Copenhagen is firmly rooted in the Scandinavian soil and nourished by Japanese minimalist aesthetics. Sharing an emphasis on quality materials, techniques and traditions, the meeting between the North and the East is notable in the holistic collections of 101 Copenhagen. The design approach is dynamic and characterised by freedom of expression - creating unique and timeless pieces without compromising on playfulness and individuality.

## OUR DESIGN TEAM

An attention to detail and a shared sense of aesthetics is what drives the two main designers of 101 Copenhagen, Tommy Hyldahl and Kristian Sofus Hansen. Merging their backgrounds and experiences from the fashion industry, the Royal Danish Academy of Fine Arts and travels in Japan respectively, a narrative of minimalist, sculptural and conceptual design is evident throughout the collections. Translating and transforming the simplistic inspiration from Japan in a Scandinavian context is all about honouring quality, heritage and materiality while never seizing to compromise on form and function. Trained as an architect, the third designer, Nicolaj Noddesbo, adds knowledge on innovative light solutions and timeless novelties to the 101 Copenhagen collections. 101 Copenhagen is a curated selection of tactile, bold objects standing out in a crowd and gathers as a whole.

**CONGRATULATIONS  
ON YOUR NEW PRODUCT FROM  
101 COPENHAGEN**



## Drop Wall Lamp

Its detailed suspension has industrial and maritime references and is beautifully crafted in plated metal, which is subsequently hand brushed to obtain the perfect finish to complement the circular opal glass lampshades. While The Drop Chandelier Bulb collection honors the iconic, modernist lamp designs of the 1950s, it also celebrates an experimental, innovative approach with its 14 flexible and functional adjustable arms - creating countless options and variations. The chandelier and the wall lamp elegantly brightens the room with a warm light and becomes a sculptural object in the ceiling and on the wall. Designed by Kristian Sofus Hansen & Tommy Hyldahl.

Product no: 203042

Type: Wall Lamp / Indoor

Designer / Year of design:

Kristian Sofus Hansen & Tommy Hyldahl,  
2017

Colour / Material:

Metal: Plated metal / Grey

Opal glass / White

Cable: Fabric covered cable / Black

Dimensions:

L18 / W18 / H66 CM

Cable lenght: 200 CM

Country of origin: CN

Product weight: 2,00 Kgs

Packaging:

Dimensions: L65 / W30 / H21 CM

Total weight incl. product: 3,00 Kgs

Number of parcels: 1

Material: Brown cardboard

Light source:

Socket: E14 - 2W - 230V

Recommended Light Source:

Pygmy - Matt Porcelain - E14

Dimmability: Please note this light source is not dimmable.

Can be fitted with an aligned dimmer

Care instructions:

Use a soft dry cloth to clean the product.

Do not use household cleaners.

Certificates: EMC, LVD, UKCA

Does not comply with US Standards.

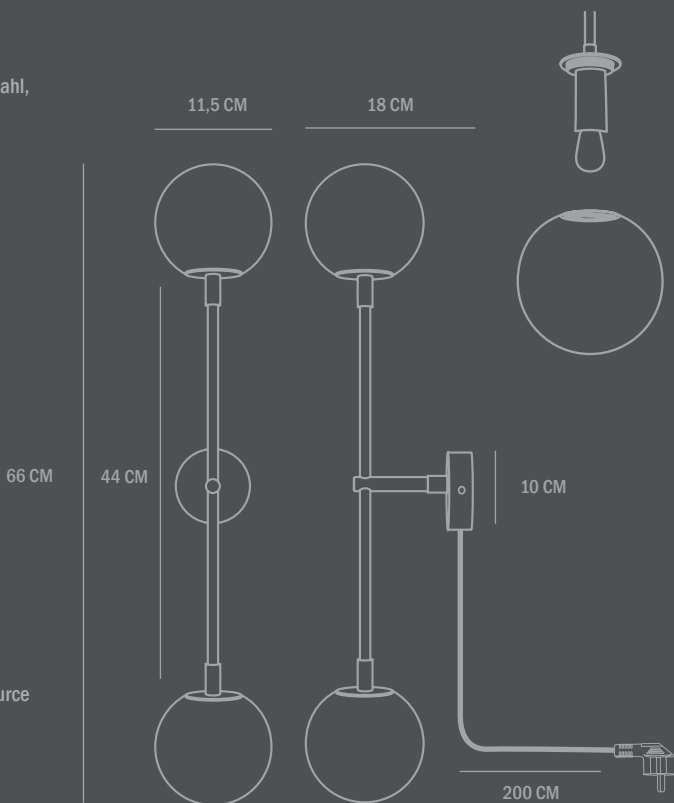

## IMPORTANT

---

Always shut off power to the circuit before starting installation work. In some countries electrical installation work may only be carried out by a authorised electrical contractor. Contact your local electricity authority for advice.

### SAFTY INSTRUCTIONS:

Please note the information contained in these instructions and save this manual, also when lamp is already mounted.

### GENERAL INSTRUCTIONS:

- Electrical connections may only be carried out by qualified staff.
- The manufactures do not accept responsibility for injuries or defects caused by improper use of this lamp.
- Attention! Before starting the installation, disconnect the power by turning off the circuit breaker, or by removing the fuse at the fuse box.
- Mind to use this lamp for its predetermined function. For example don't mount indoor lamps in outdoor areas.
- Please check all components are complete before installing.
- Don't cover the lamp.
- Don't connect the lamp to power and don't switch it on when it's in packing.
- Bulbs and transformers get very hot during operating. At improper use there is the risk of fire and by changing the bulb you can hurt yourself. Always let cool down!
- If the external flexible cable or cord is damaged, it shall be exclusively replaced by the manufacturer or his service agent or a similar qualified person in order to avoid a hazard.
- Please ensure that the specified bulb type and power of bulb is used. The maximal wattage shouldn't be exceeded (find the bulb symbol and the "max ... W" on rating label or on lamp).
- Do not mount the lamp on wet or conducting background.
- Make sure that the cables or cords don't get damaged during installation.
- The given main voltage (230V/50Hz) shall not be exceeded.
- Plug and connection elements must be free of tensile strength and torsion force.
- Don't touch bulbs with bare hands.

### MAINTENANCE INSTRUCTIONS:

- Before cleaning, disconnect the power by turning off the circuit breaker, or by removing the fuse at the fuse box.
- Mind to clean the surfaces of lamp only.
- Wetness shouldn't get in terminal box or to any conducting part.
- Before you start to clean let it cool down for 10 minutes!
- Cleaning with a soft dry cloth only.

### ADVICE FOR ENVIRONMENTAL CARE:

Don't put this article to normal domestic waste after the end of its lifecycle. You have to bring it to a staging area for electrical wastes. The materials are recyclable according to their specifications. With the correct recycling of these materials you can make a significant contribution to environmental protection. Ask your local authority for next staging area.

### CE MARKING:

By affixing the CE marking to a product, a manufacturer declares that the product meets all the legal requirements for CE marking and can be sold throughout the European Economic Area (EEA).

TO ASSEMBLE THE LAMP:

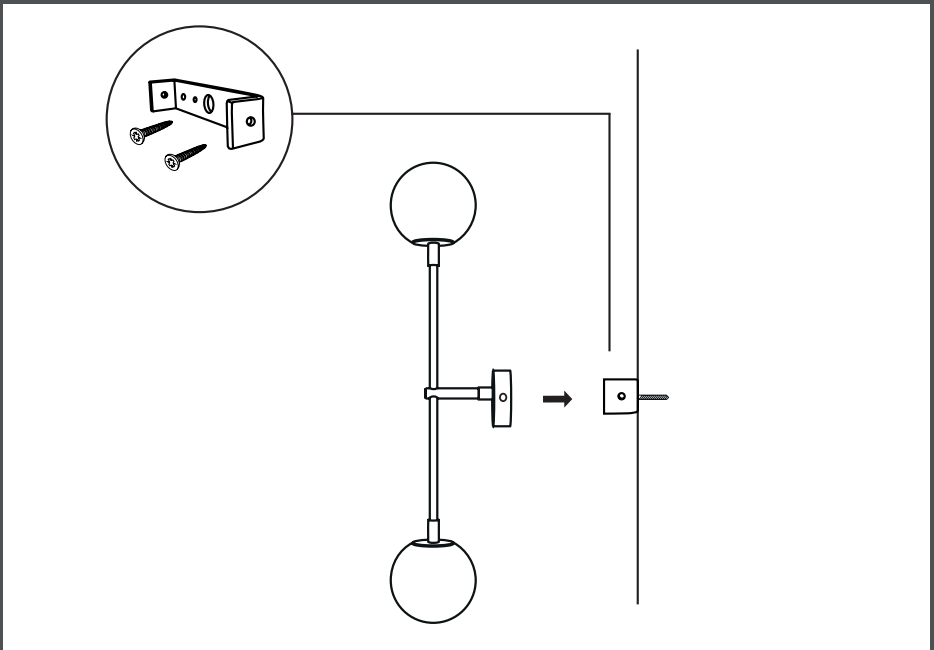

1. Detach the mounting plate from the wall lamp and mount it to the wall. Make sure to use appropriate screws and rawplugs/anchors. Mount the wall lamp to the plate on the wall using the plated screws.

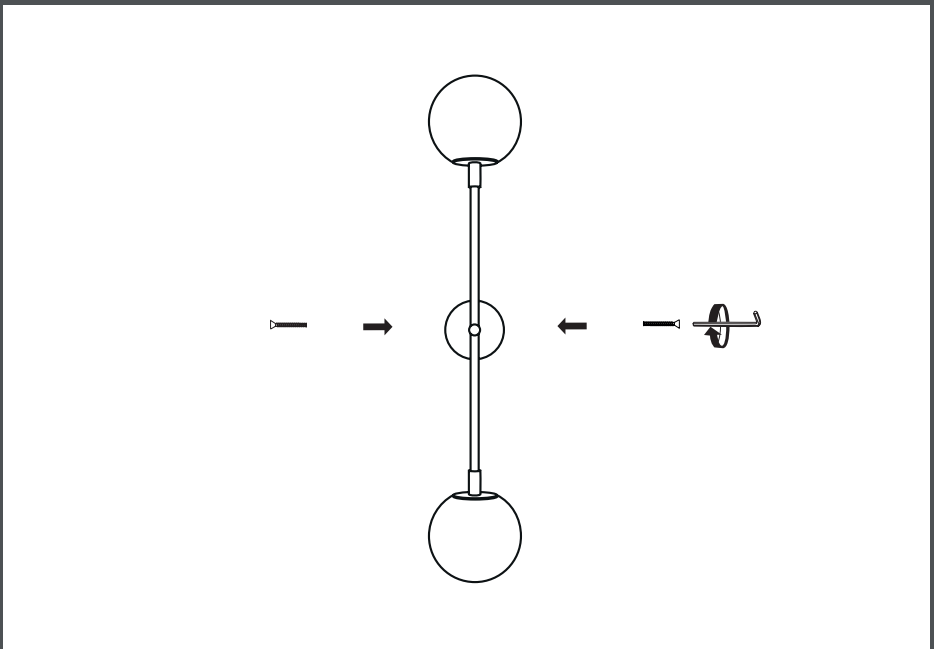

2. Turn the screws clockwise for fastening.

TO ASSEMBLE THE LAMP:

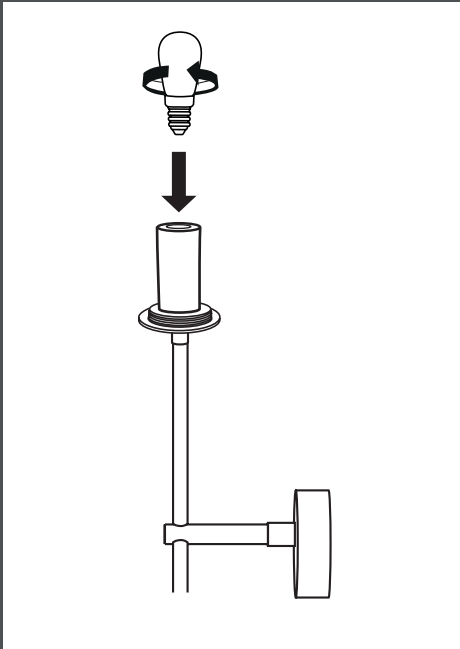

3. Place a recommended light bulb in the E14 socket.

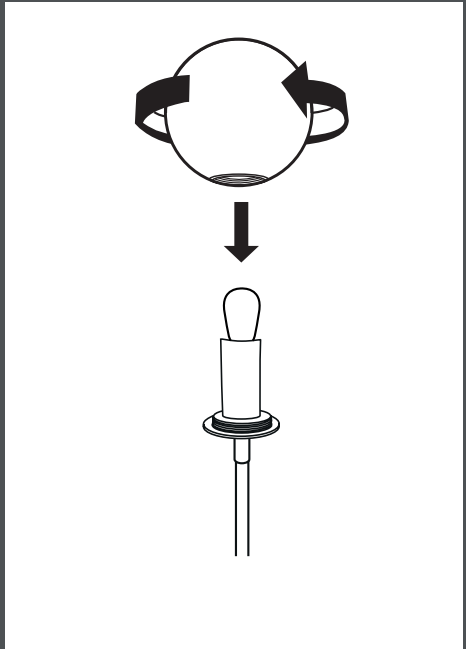

4. Carefully place the glass globe over the light bulb. Turn clockwise to attach the glass globe.

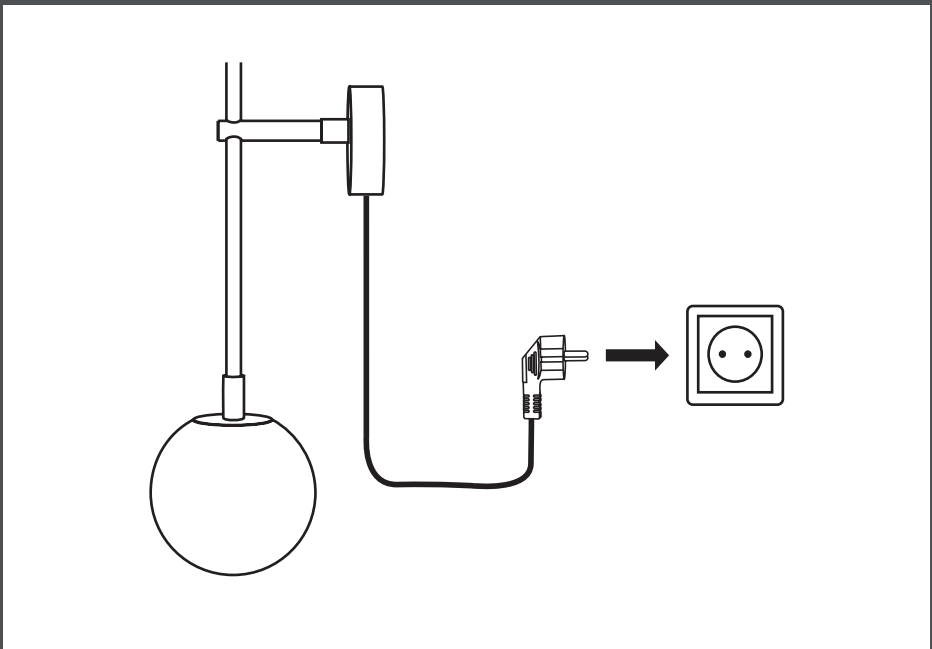

5. Plug the socket into a power outlet.





GLOBAL SALES INQUIRIES: [SALES@101CPH.COM](mailto:SALES@101CPH.COM)

SUPPORT INQUIRIES: [SUPPORT@101CPH.COM](mailto:SUPPORT@101CPH.COM)

PRESS INQUIRIES: [PRESS@101CPH.COM](mailto:PRESS@101CPH.COM)



PRESS KIT & IMAGEBANK PLEASE GO TO:

[WWW.101CPH.COM](http://WWW.101CPH.COM) OR SCAN THE QR CODE AND GAIN ACCESS TO OUR IMAGE BANK, CATALOGUE AND MORE.

SHOWROOM BY APPOINTMENT ONLY // ØSTERGADE 17, 3RD & 4TH FLOOR, 1100 COPENHAGEN, DENMARK.