





AGATHA

LUIS ESLAVA STUDIO

FAMILY

SUSPENSION

TECHNICAL DATA

SEE PG. **531**



ATA SB-20 Palau de Casavells. Art, Antiques, Design, Architecture. Girona, Spain.

AGATHA SUSPENSION BALL

Ref. ATA SB

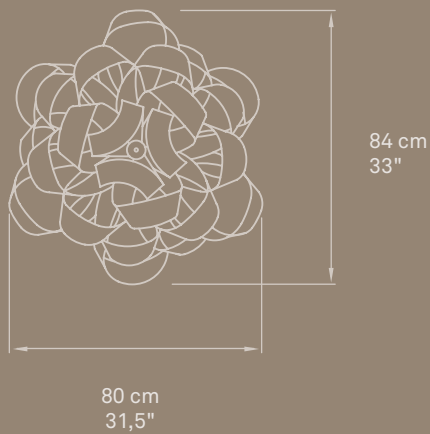
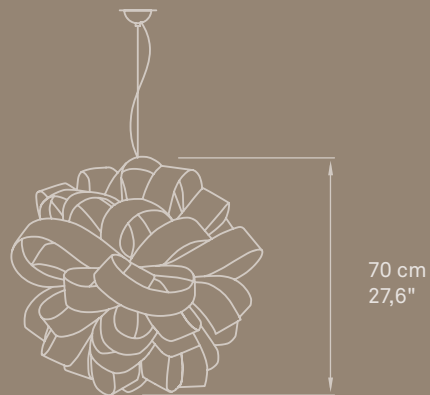



ATA SB-20 Villa El Nido. Architects: A-cero. Marbella, Spain.





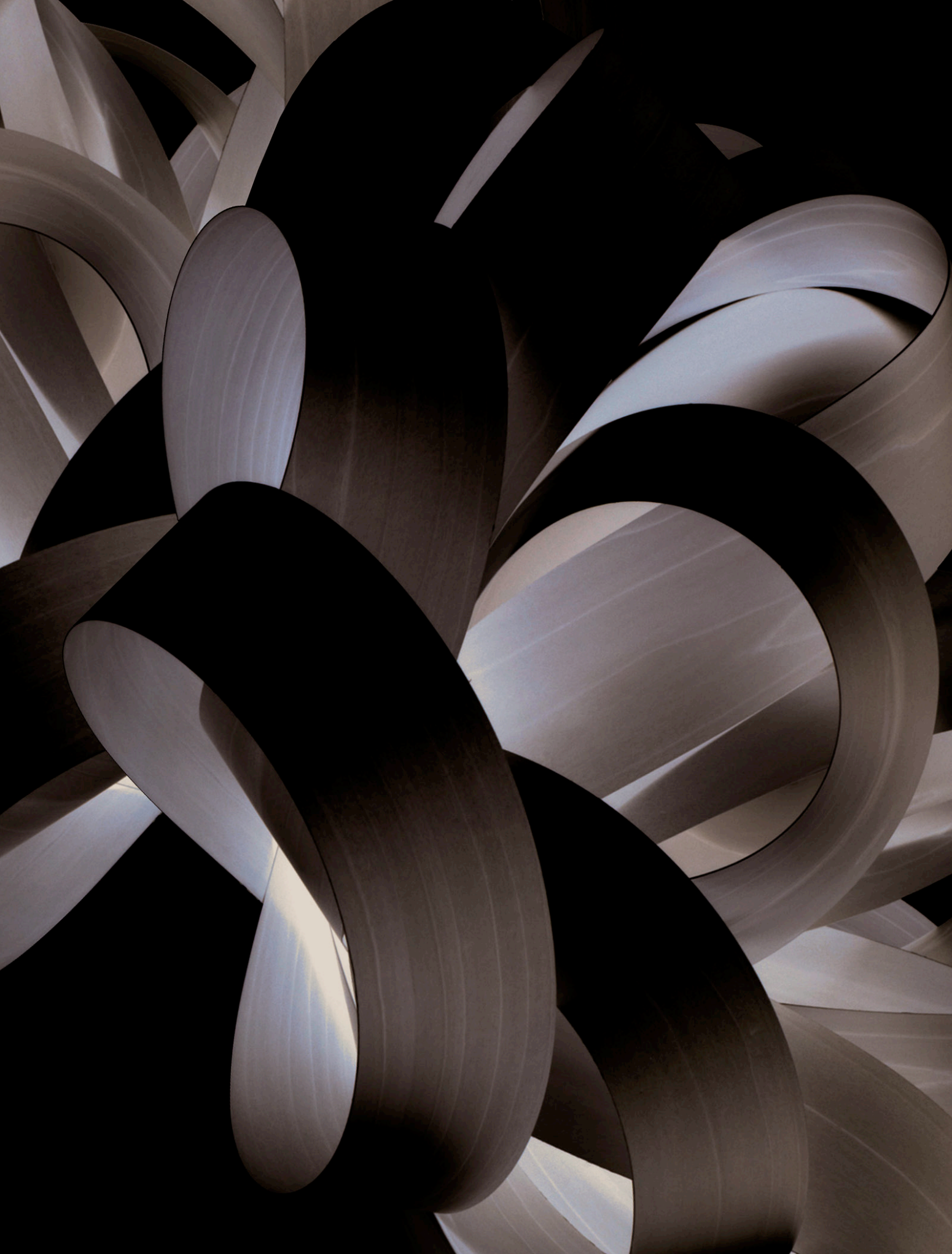



ATA SG-22 Library, Los Gatos, California. Noll & Tam Architects. Lighting Designer Illuminosa.

AGATHA LARGE SUSPENSION

Ref. ATA SG

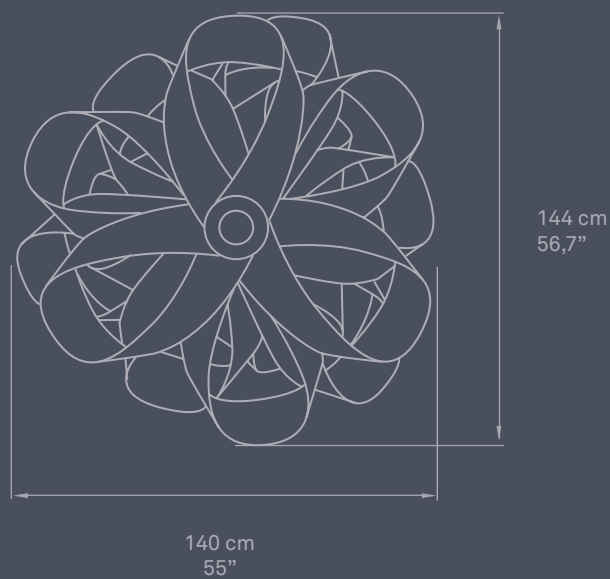
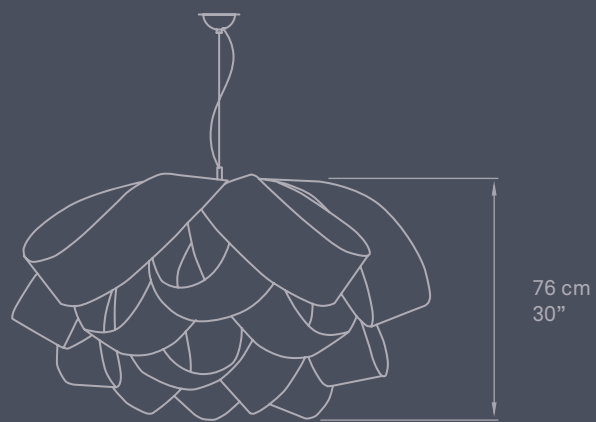



ATA SG-20 Palau de Casavells. Art, Antiques, Design, Architecture. Girona, Spain.



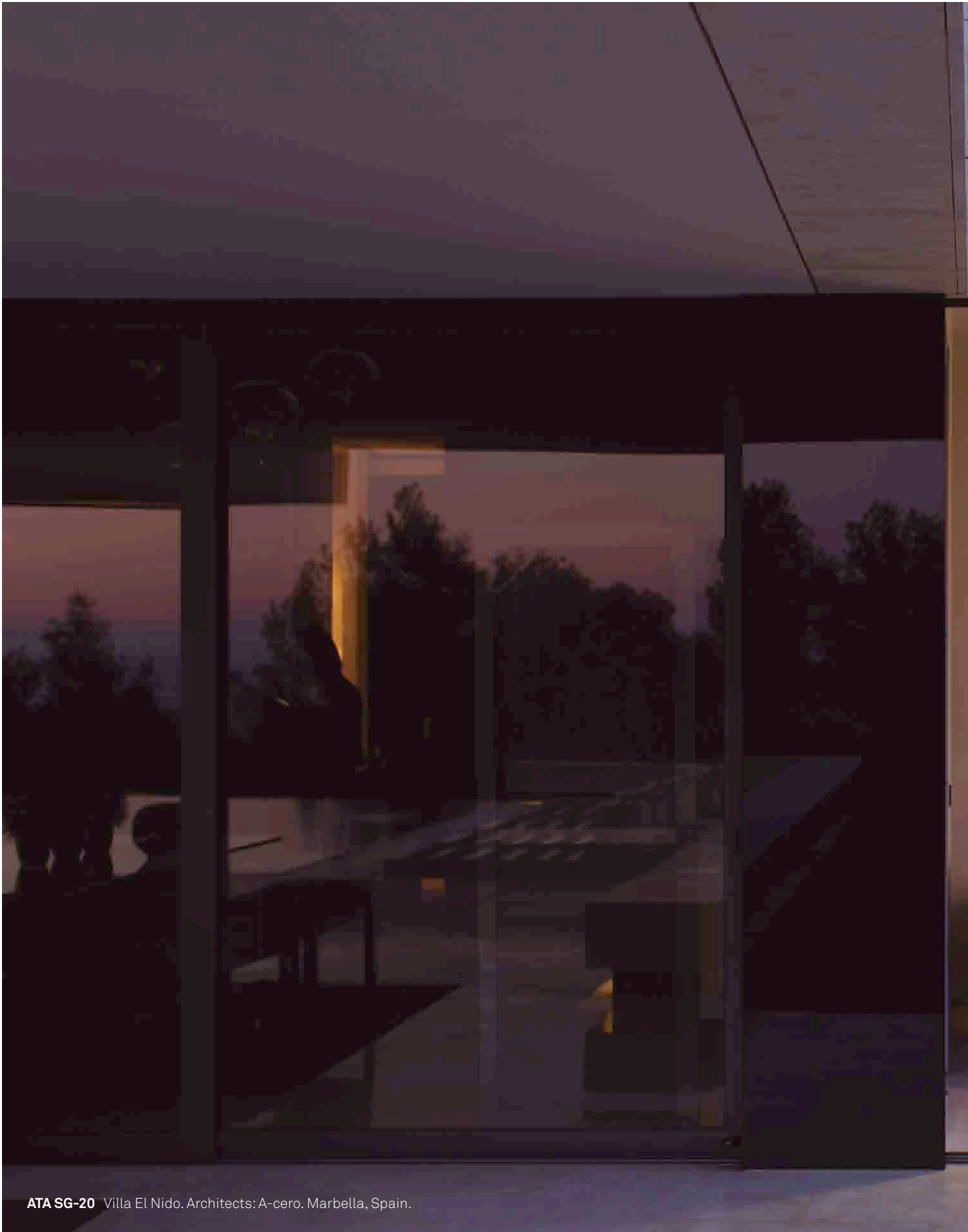

ATA SG-20 Villa El Nido. Architects: A-cero. Marbella, Spain.





AGATHA

SMALL SUSPENSION

Ref. ATA SP

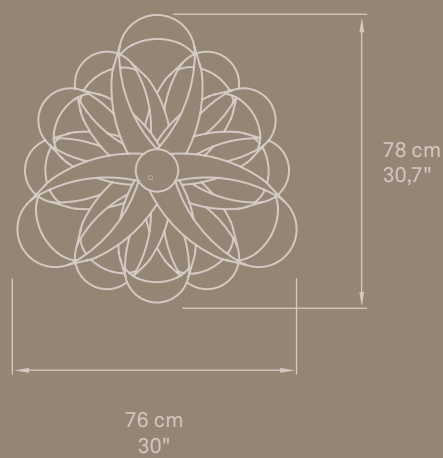
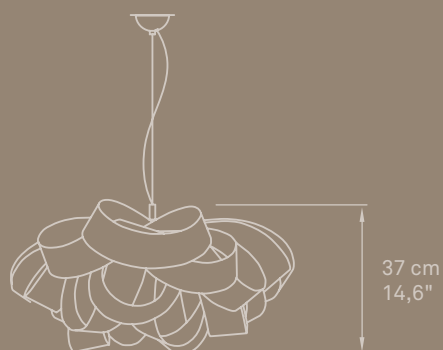

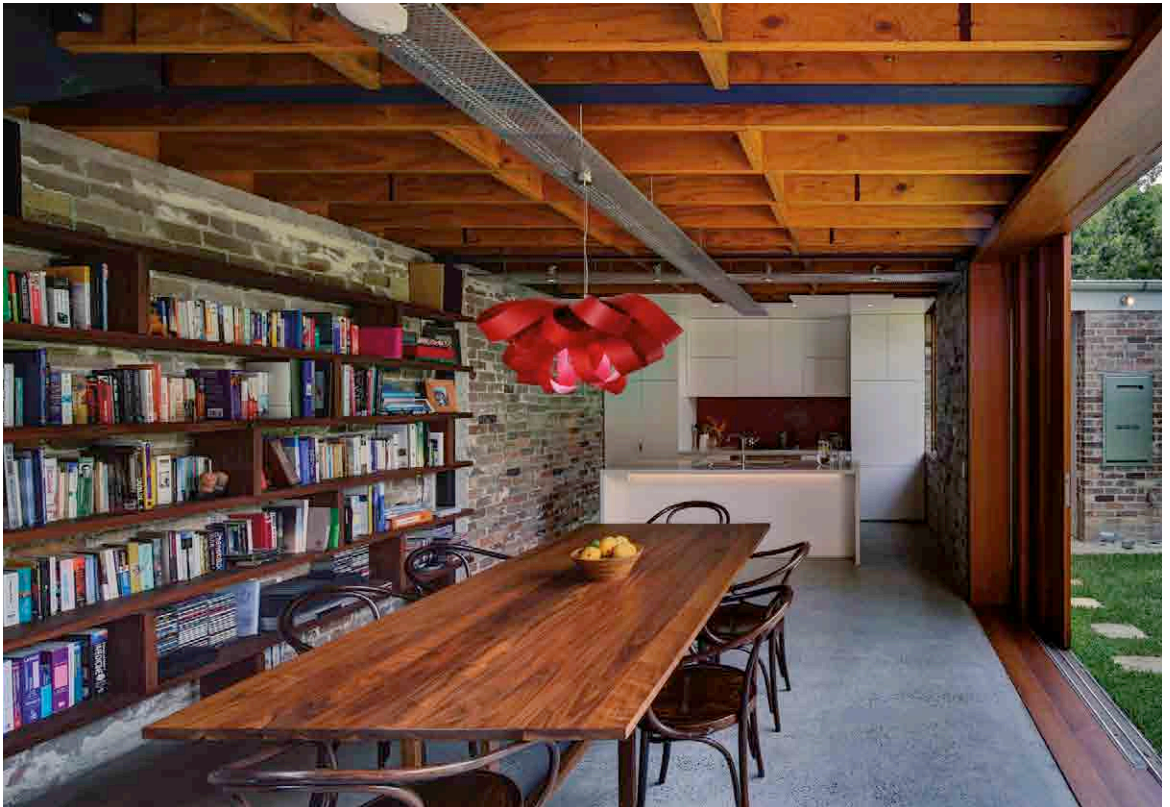

ATA SP-26

Project:
House Forest
Lodge

Location:
Sydney

Architects:
Carterwilliamson
Architects

Photography:
Brett Boardman



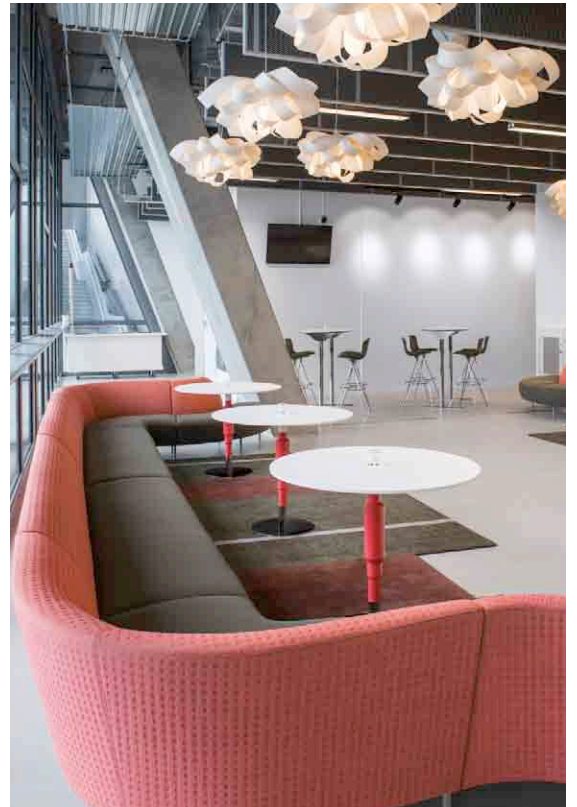
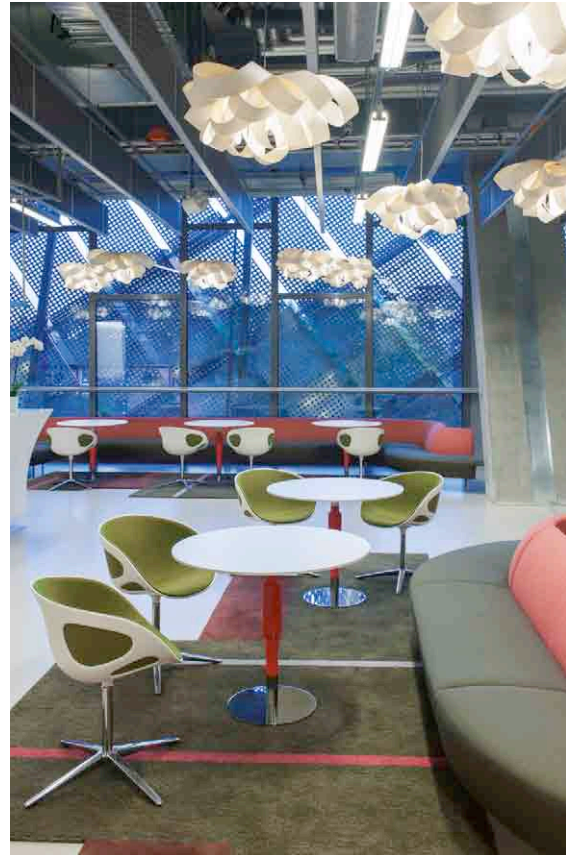

ATA SP-20

Project:
Tele2 Arena
stadium

Location:
Sweden

**Interior
Designers:**
InPut interior

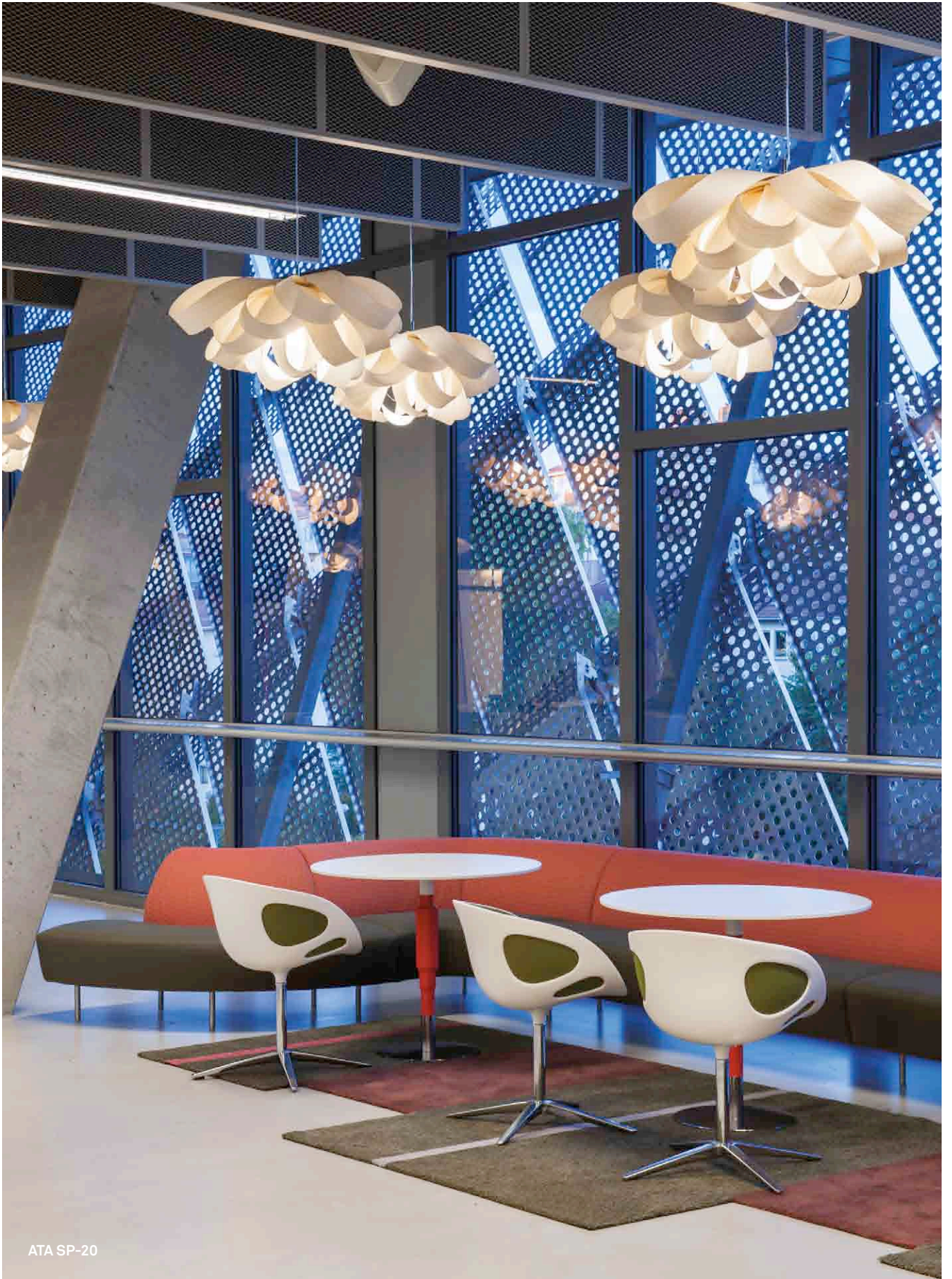





NATURAL TIMBER VENEER

SWITCHED ON



21 Cherry



22 Beech

COLOURED NATURAL TIMBER VENEER



20 Ivory white



28 Blue



24 Yellow



29 Grey



25 Orange

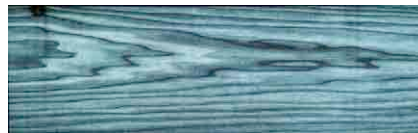

30 Turquoise



26 Red



31 Chocolate

Please only use these reproductions as a guide. Use LZF wood swatches to see the spectacular real effect of the illuminated veneers.



32 Pink

NATURAL TIMBER VENEER

SWITCHED OFF



21 Cherry



22 Beech

COLOURED NATURAL TIMBER VENEER



20 Ivory white



28 Blue



24 Yellow



29 Grey



25 Orange



30 Turquoise



26 Red



31 Chocolate

Please only use these reproductions as a guide. Use LZP wood swatches to see the spectacular real effect of the illuminated veneers.



32 Pink

ATA SP SMALL SUSPENSION

REFERENCE

ATA SP

CERTIFICATES

CE
Class I
230V
E27

COMPONENTS

Metal canopy Brushed Nickel
ø 10 cm - disc 14 cm
Electrical cable Transparent 2 m drop
Steel cable 2 m drop

BULBS (x1) - Not included

WOOD SHADE COLORS



See pg. 525

AWARDS



HD Las Vegas 2011



World Architecture Award 2011

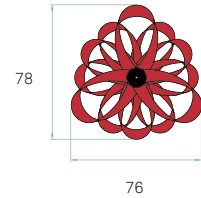
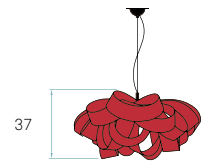

ATA SB BALL SUSPENSION

REFERENCE

ATA SB

CERTIFICATES

CE
Class I
230V
E27

COMPONENTS

Metal canopy Brushed Nickel
ø 10 cm - disc 14 cm
Electrical cable Transparent 2 m drop
Steel cable 2 m drop

BULBS (x6) - Not included

WOOD SHADE COLORS



See pg. 525

AWARDS



HD Las Vegas 2011



World Architecture Award 2011

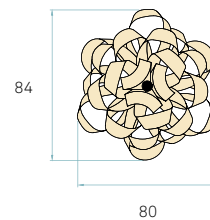
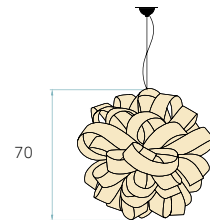

ATA SG LARGE SUSPENSION

REFERENCE

ATA SG

CERTIFICATES

CE
Class I
230V
E27

COMPONENTS

Metal canopy Brushed Nickel
ø 10 cm - disc 14 cm
Electrical cable Transparent 2 m drop
Steel cable 2 m drop

BULBS (x3) - Not included

WOOD SHADE COLORS



See pg. 525

AWARDS



HD Las Vegas 2011



World Architecture Award 2011

