

MegaVID WiFi Digital Camera User Manual

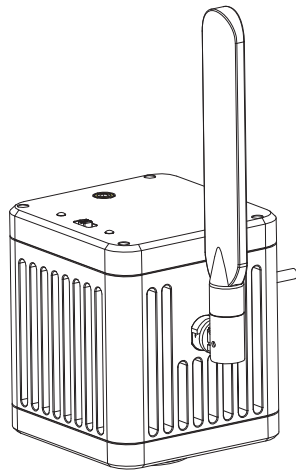

Content

Chapter 1 Notes And Safety Requirements	- 1 -
1.1 Cautions and notes	- 1 -
Chapter 2 Package List	- 2 -
Chapter 3 Hardware Introduction	- 3 -
Chapter 4 Installation Methods	- 4 -
4.1 Camera install to a trinocular microscope	- 4 -
4.2 Remove camera from microscope	- 4 -
Chapter 5 Connection Methods	- 5 -
5.1 USB connection	- 5-6 -
5.2 HDMI connection (only for 12.0MP camera)	- 6 -
5.3 5G WiFi connection	- 6-7 -
5.4 Local area network connection	- 7-8-
Chapter 6 Troubleshooting And Frequently Asked Questions	- 9 -
6.1 USB image acquisition problems	- 9 -
6.2 WiFi image acquisition problem	- 9 -
6.3 Interface problems	- 9 -
Chapter 7 Disclaimer	- 10 -

1.1 Cautions and notes

- (1) To avoid danger or damage incurred to the lens, do not touch the lens or sensor directly with your fingers.
- (2) To avoid failure or electric shock hazard and so on, do not disassemble or modify the internal structure of the device.
- (3) Do not plug in or unplug the USB port or the HDMI port when hands are wet.
- (4) Do not use alcohol and other organic solvents to clean.
- (5) If the lens or sensor is dirty or damp, you should better use dry and non-linen fabric or professional lens tissue to wipe them.
To avoid scratches on the surface, do not touch the lens with your fingers. Wipe the lens or sensor lightly.
- (6) The products are not specifically designed for an outdoor use. Do not expose it to outdoor environment without any protection.
Excessive temperature and humidity will damage the lens. Please avoid using the product under the following environment:
high temperature or high humidity environment, places with direct sunlight, dirt or vibration and places near heat source.
- (7) Please use and store in the following environment:
Operating temperature : 0°C~ 40°C;
Storage temperature: -10°C~ 60°C;
Operating Humidity : 30~60%RH;
Storage Humidity: 10~80%RH.
- (8) If any foreign matter, water or liquid enter into the device by accident, disconnect the USB cable immediately. Please send it to the maintenance center and do not use the hair dryer to dry it by yourself.
- (9) To prevent microscope from being tripped over or dropped, please put away the device's USB cables in use or standby.
- (10) To avoid electric shock by accident, please power off microscope before you move your Windows PC or laptop.
- (11) The cleanliness of the device lens will directly affect clarity degree of contents from the computer screen during preview.
Problems like various circles or spots on the screen may mostly be incurred by dirt on the lens. When cleaning, please use professional lens tissue or other professional detergent to clear the dirt on the lens.

Chapter 2 Package List

1. WiFi camera (C-mount)



2. HDMI cable (2m)
(only for 12.0MP camera)



3. Gigabit Ethernet cable (2m)

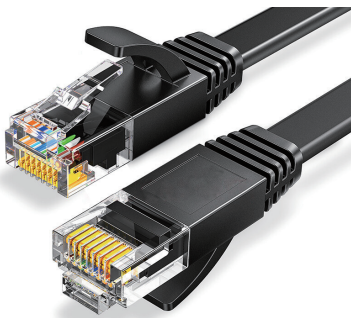

Chapter 3 Hardware Introduction

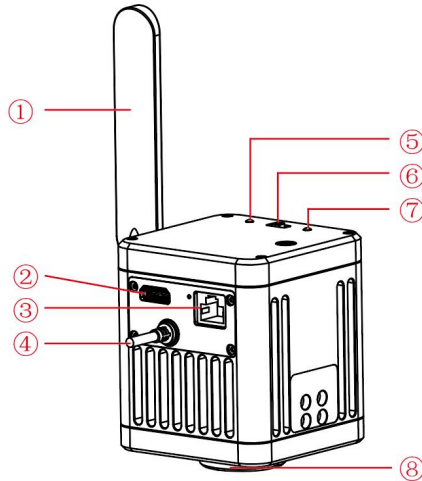

①	5G WiFi antenna	enhance the 5G WiFi signal transmission, to achieve wireless connection to the camera for image acquisition.
②	HDMI output interface (only for 12.0MP camera)	through HDMI cable, connect with external monitor with HDMI interface to realize video, signal transmission, etc.
③	WAN network interface	turn to WiFi: it can be connected to the router and access to the local area network, so that Windows PC, smart phones and tablets in the local area network can share the microscopic screen; it can also be directly connected to the Internet.
④	USB output / power supply	turn to USB: connects to Windows PC for data transfer, and the Windows PC side can image acquisition through software. turn to WiFi: connects to adapter to enable powering the camera, and wireless devices can connect to the camera WiFi to image acquisition.
⑤	PWR (Power indicator)	turn to OFF, the indicator light is red. turn to USB or WiFi, the indicator light is green.
⑥	USB / OFF / WiFi working mode switching	USB: when the USB cable connected to the computer, it can image acquisition through the computer software. OFF: turn off the power, the camera stops working on this time. WiFi: the wireless devices connect to the camera WiFi to image acquisition.
⑦	ACT indicator	turn to WiFi, the indicator light is blue. turn to other gears, the indicator light does not light up.
⑧	Standard C -mount	connect with trinocular microscope which has C-mount.

4.1 Camera install to a trinocular microscope

- (1) Remove the dust cover of microscope standard C -mount, as shown in Figure 1.
- (2) Snap the camera onto the standard C -mount of the microscope, oriented as in Figure 2; tighten the fastening screws on the standard C-mount of the microscope, fix the camera on the microscope.

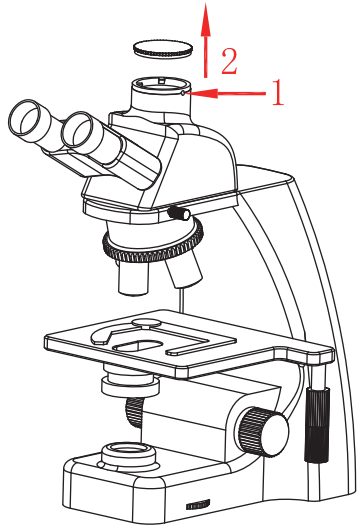

Figure 1

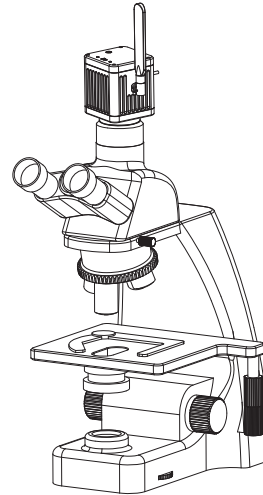
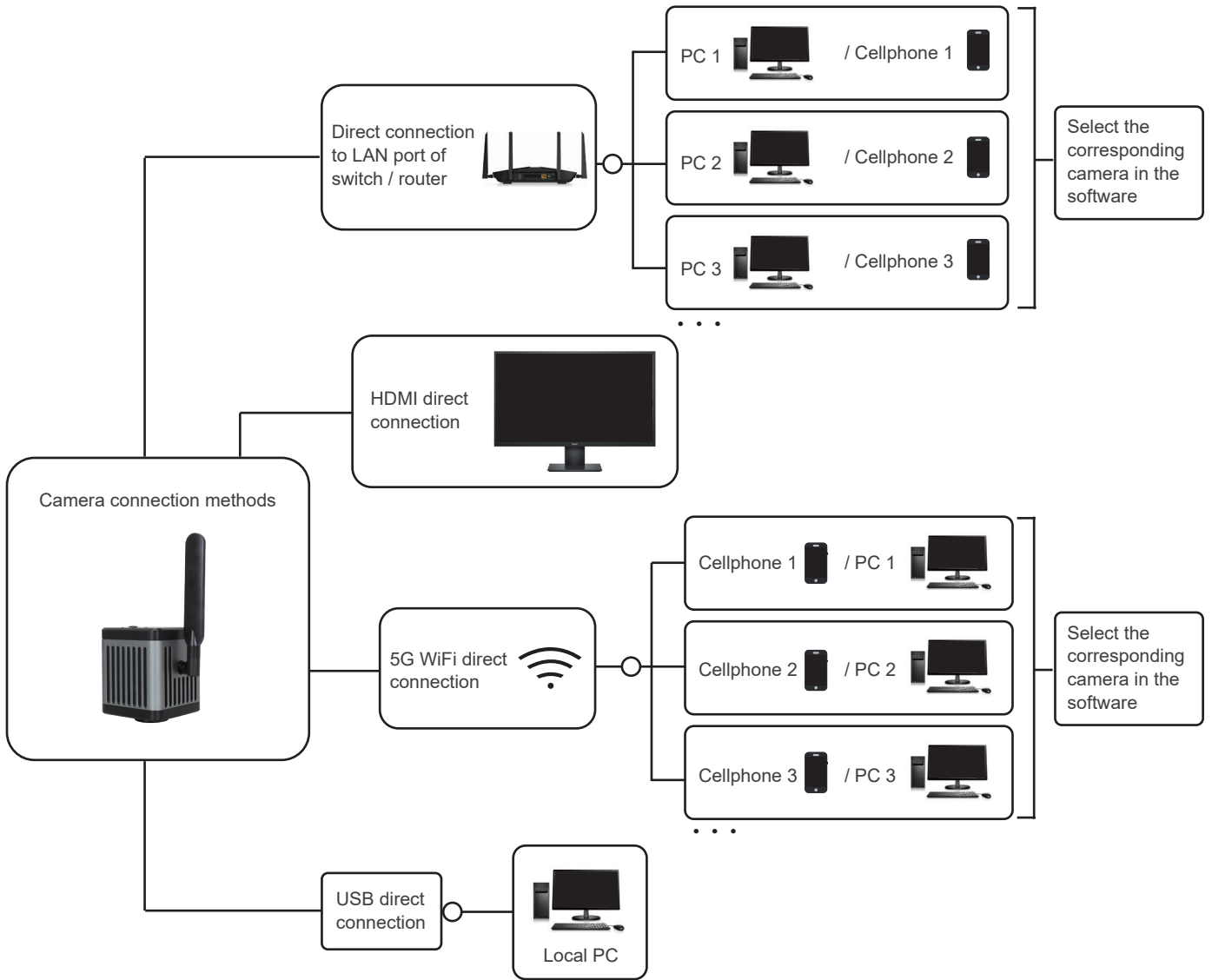

Figure 2

4.2 Remove camera from microscope

Reverse the order with the installation.

Chapter 5 Connection Methods



Output methods:

12.0MP Camera: 5G WiFi+WAN+HDMI; USB+HDMI (USB and WiFi cannot be output at the same time).

5.1 USB connection

Steps:

- (1) Camera USB cable connect to the USB port of a Windows PC;
- (2) Toggle switch to USB gear;
- (3) Install from the CD and run LW Scientific Capture Pro software.

Please refer to the "LW Scientific Capture Pro Software User Manual" for details.

Windows System Requirements

Microsoft Windows 10 (64 bit) or later version operating systems.

CPU: i5 10th generation or later version.

Hard drive: 512GB or more.

Memory: 16GB or more.

Graphics card: Core graphics.

Network card: 10/100/1000M adaptive.

5.2 HDMI connection (only for 12.0MP camera)

Steps:

(1) Switching to USB gear when the camera is powered on, HDMI cable connected to the monitor, can be straight out of the microscope screen.

(2) Switching to WiFi gear when the camera is powered on, HDMI cable connected to the monitor, can be straight out of the microscope screen.

(3) When connecting HDMI to an external monitor, you should select the appropriate HDMI output resolution ratio in the Windows PC software LW Scientific Capture Pro settings according to the aspect ratio of the monitor, otherwise the image display of the external monitor will be stretched and distorted.

Note: The external monitor is connected to the camera via HDMI, the external monitor only transmits images without any operation software and menu, if you need to adjust the image parameters, you need to control through the Windows PC software LW Scientific Capture Pro, or mobile version APP LW Scientific. Supports simultaneous HDMI and 5G WiFi output.

5.3 5G WiFi connection

(1) Desktop computers, cell phones, tablets, and laptops can be connected to the camera via 5G WiFi, supports up to 13 desktop computers, cell phones, tablets and laptops can realize microscopic view on the same microscope screen.

Windows System Requirements

Microsoft Windows 10 (64 bit) or later version operating systems.

CPU: i5 10th generation or later version.

Hard drive: 512GB or more.

Memory: 16GB or more.

Graphics card: Core graphics.

Network card: 10/100/1000M adaptive.

Wireless NIC supports 5G WiFi IEEE802.11ac.

Android System Requirements

Android System 7.0 or later version.

CPU dual-core 1.7Ghz or later version.

Memory RAM 3GB or more.

Storage ROM 32GB or more.

Support wireless protocol 5G WiFi IEEE802.11ac.

iOS System Requirements

IOS System 11.0 or later version.

CPU dual-core 1.8Ghz or later version.

Memory RAM 2GB or more.

Storage ROM 32GB or more.

Support wireless protocol 5G WiFi IEEE802.11ac.

(2) Download and install the APP:

1) Use the APP installation package from the CD to install;

2) Choose LW Scientific for Android or LW Scientific for iOS to download and install according to your phone and tablet system;

3) You can search and download LW Scientific from Google Play APP store;

4) You can search and download LW Scientific from Apple APP Store.

(3) Connection steps:

- 1) Connecting the camera USB cable to the power adapter or the USB port of the Windows PC, which is required to meet 5V 2A to power the camera;
- 2) Set the camera to WiFi gear. After about 20 seconds, the camera's WiFi working signal indicator stops flashing and remains on;
- 3) Search for the camera's WiFi SSID: WiFi5Camera_xxxxxx on the desktop computers or laptops; default connection password: 12345678, running the Windows software LW Scientific Capture Pro to start image acquisition.
- 4) Cell phones, tablets scan QR code to get the images automatically:
Run the APP LW Scientific; Click the "📷" button on the navigation interface, scan the QR code on the camera body to connect to the microscope screen, no need to enter password, realize the same screen view.

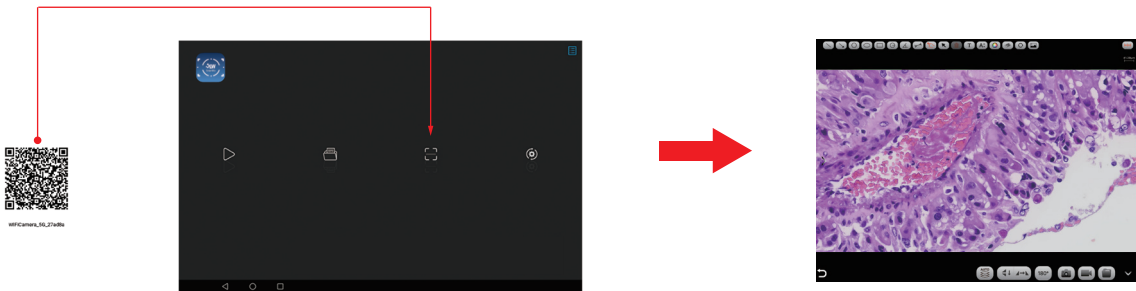

5) Cell phones, tablets manually connect to get images:

Search for the camera's WiFi SSID: WiFi5Camera_xxxxxx in the WLAN of cell phones or tablets; default connection password: 12345678.

Run the APP LW Scientific, enter the APP LW Scientific navigation interface, and click "▶" the button to connect to the microscope screen manually.



WiFi connection is recommended for short distance transmission and local area network connection is recommended for long distance transmission.

5.4 Local area network connection

Once the camera connected to a local area network, it can be changed to a network camera. Up to 13 desktop computers, cell phones, tablets and laptops on the same local area network can realize synchronized real-time preview.

5.4.1 The method for connect the camera to a local area network

- (1) Switching to WiFi gear when the camera is powered on;
- (2) Plug one end of the network cable into the WAN port of the camera and the other end into the LAN port of the local area network router.

Notes:

- 1) The local area network must support 5G WiFi IEEE802.11ac protocol, otherwise it cannot be displayed in the list.
- 2) If the local area network opens the Internet function, the camera can also access the Internet.

5.4.2 Retrieve images via the local area network from a Windows PC on the same local area network

- (1) Connect a Windows PC or laptop that supports 5G WiFi IEEE802.11ac protocol to the same local area network as the camera.
- (2) Install and run the software LW Scientific Capture Pro on the Windows PC or laptop.
- (3) When there is only one network camera in the local area network, the software can automatically get the live image from the camera.
- (4) When there are multiple network cameras in the same local area network, click the icon "  " in the upper right corner of LW Scientific Capture Pro (Figure 1), the list automatically shows all cameras in the current local area network (Figure 2), select a camera as needed, support switching midway at any time.

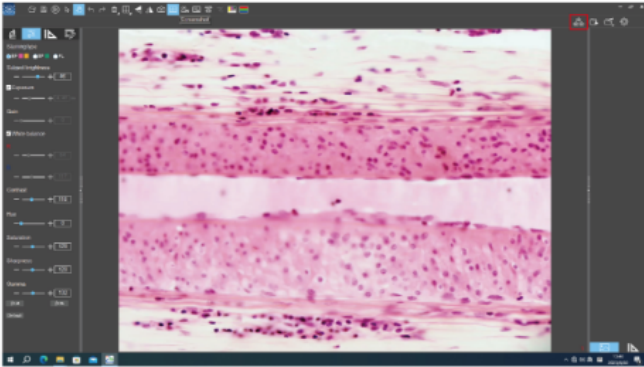

Figure 1





Figure 2

Notes:

When a Windows PC or laptop computer accesses the camera microscope images, it does not affect the computer's ability to access the Internet, and if that local area network is open to the Internet, the Windows PC or laptop can also access the Internet.

5.4.3 Retrieve images via the local area network from cell phones and tablets in the same local area network

- (1) Connect the cell phones or tablets that supports 5G WiFi IEEE802.11ac protocol to the same local area network as the camera.
- (2) Install and run the APP LW Scientific on the cell phones or tablets, enter the navigation interface and click the "  " button.
- (3) When there is only one network camera in the local area network, the APP can automatically get the live image from the camera.
- (4) When there are multiple network cameras in the same local area network, click the icon "  " in the navigation interface (Figure 1), pop-up menu (Figure 2). The list automatically shows all cameras in the current local area network (Figure 3), select a camera as needed, support switching midway at any time.

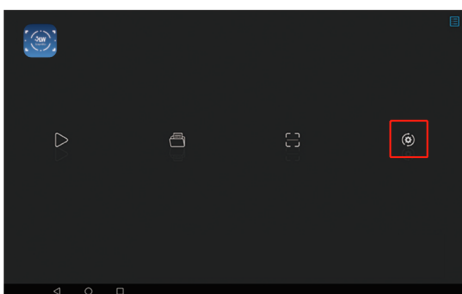

Figure 1

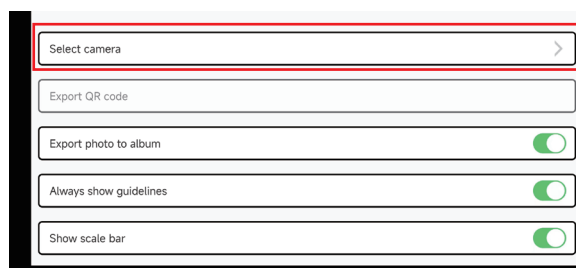

Figure 2

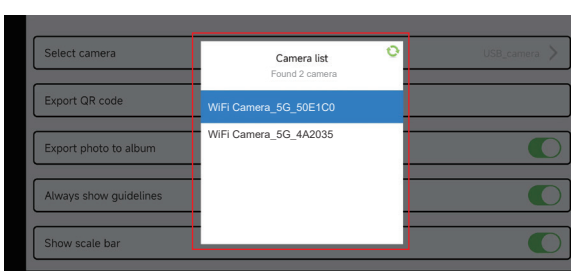

Figure 3

6.1 USB image acquisition problems

6.1.1 Image acquisition failure

- (1) Ensure that the microscope has turned on the light and the image is visible to the eyepiece;
- (2) Ensure that the USB port of the computer is working properly;
- (3) Ensure the computer can recognize the camera (you can find the "USB Camera" in the "Device Manager" of the computer), if the camera is still not recognized after re-plugging the USB cable, please contact our customer service;
- (4) If the computer can recognize the camera, but can not image acquisition, please reinstall the software "LW Scientific Capture Pro", to obtain the installation package, please contact our customer service or go to download the software from the official CD, please close the antivirus software in your computer when reinstalling the software to prevent the installation from being intercepted by antivirus software;
- (5) If the fault cannot be eliminated after restarting the camera, please contact our customer service.

6.2 WiFi image acquisition problems

6.2.1 WiFi cannot be connected

- (1) Ensure that the mobile device can search the camera's WiFi, if the camera's WiFi cannot be searched even after changing devices, please contact our customer service;
- (2) Ensure the APP LW Scientific on your mobile device can scan the QR code on the camera body and connect to the camera's WiFi, if the APP prompts "WiFi cannot be connected", you need to allow the APP LW Scientific to modify the system settings in your phone's settings.

6.2.2 Image acquisition failure or large delay

- (1) Ensure that the USB gear can have an image display;
- (2) Ensure the APP LW Scientific on your mobile device can scan the QR code on the camera body and connect to the camera's WiFi, if the APP prompts "WiFi cannot be connected", you need to allow the APP LW Scientific to modify the system settings in your phone's settings;
- (3) Ensure turn off data traffic on your phone, or turn off "Use data traffic to improve network" in your phone settings;
- (4) If faulty cannot be eliminated, please contact our customer service.

6.2.3 No image display in WiFi output method

- (1) Ensure that the microscope has turned on the light and the image is visible to the eyepiece;
- (2) Ensure that the camera and the mobile device are under the same local area network;
- (3) If faulty cannot be eliminated, please contact our customer service.

6.3 Interface problems

6.3.1 External HDMI monitor does not display / display exceptions

- (1) Ensure the HDMI cable can be used normally;
- (2) Ensure the HDMI monitor can be used normally;
- (3) Ensure that the external HDMI monitor can support 3840x2160 @30Hz/1920x1080 @60Hz/1920x1080 @30Hz/1280x720 @60Hz;
- (4) If faulty cannot be eliminated, please contact our customer service.

Chapter 7 Disclaimer

(1) In order to protect the legitimate rights and interests of users, please carefully read the instructions, disclaimers and safety instructions provided with this product before using it. The company reserves the right to update the above documents. Please operate the product according to the instructions and safety instructions.

(2) Once you begin to use the product, you shall be deemed to have read, understood, recognized and accepted all terms and contents of the product's instructions, disclaimers and safety instructions. Users undertake to be responsible for their actions and all consequences. User undertakes to use the product only for legitimate purposes and agrees to these terms and any relevant policies or guidelines that the company may establish.

(3) In the process of using this product, please strictly abide by and execute the requirements including but not limited to the instructions and safety instructions. All personal injuries, accidents, property losses, legal disputes and other adverse events that cause conflicts of interest caused by violation of the safety instructions or irresistible factors shall be borne by users themselves, and the company shall not assume any responsibility.

(4) Safety instructions:

- 1) Please do not use wet hands to plug and unplug the power supply of the equipment.
- 2) Please be sure to use a regular brand power socket, and make sure the grounding is well grounded to prevent electric shock.
- 3) Please be sure to make regular safety checks on sockets and plugs to avoid potential electrical safety hazards caused by aging and short circuit.
- 4) Please be sure not to use the product in a humid or hot environment to ensure the safety of the product.
- 5) Please be sure to loosen bundle cords of the power cable before using, to avoid electromagnetic induction and heating, thus increasing the heat dissipation speed.
- 6) Please be sure not to use the product equipment or socket or other places in high or easy to fall, so as to avoid damage.
- 7) Before opening the socket power supply, please be sure to turn off the load power switch of the product equipment.
- 8) The company reserves the rights to improve product, upgrade technology and change parameters without prior notice.

LW Scientific, Inc.