



User Manual

iTrite Electronic Titrator

Content

1. Unpacking	1
2. Overview	2
3. Parts Description	3
4. Assembly Instruction	10
5. Operation	16
6. Function Setting	21
7. Accessories	23
8. Calibration	29
9. Cleaning and Maintenance	30
10. Trouble Shooting	35
11. Storage	37
12. Warranty	38
13. Limitations and Compatibility	38

Safety Reminder

 **CAUTION:** Possible damage to instrument. Caution notes indicate any condition or practice, which if not strictly observed or remedied, could result in damage or destruction of the instrument.

1. Unpacking

The iTrite package should contain the following items.

iTrite Electronic Titrator Include:

- Titrating pipe X1
- Titrating pipe cover X1
- iTrite X1
- AC Adapter X 1
- Controller X 1
- Controller cable USB X 2
- Bottle Adapter X 5(GL32; GL38; GL28; GL25; S40)
- Magnetic Stirrer X 1
- Remote Titrating pipe X 1
- Remote Control Handle X 1
- Stirrer Bar (20mm) X 1
- Filling valve X 1
- Dispensing valve X 1
- Filling pipe X 2
- Installation tools X 1
- Stander

Please check that all the items are present and inform your supplier immediately if any of the above are missing.

2. Overview

A digital titrating instrument, iTrite delivers accurate and precise bottle-top titration.

Please refer to "Limitations and Compatibility" for liquid compatibility prior to operation.

2.1 Specification

Volume Range	0.01mL-99.99mL Increment 10 μ L
Precision	R= 0.2% CV=0.07%
Velocity	16 Stages
Battery	Capacity : 4000mA/h Fully charged in 4 hours (please use standard charger) working time : about 5 hours

2.2 Limitations of Use

- Temperature: 15 ~ 40°C
- Vapor pressure: <500mbar
- Viscosity: <500mm²/s
- Humidity: 20~90%

3. Parts Description

3.1 iTrite

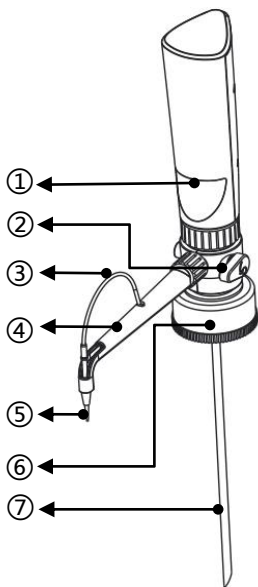

No.	Description
①	Liquid Level Observation (in piston running state)
②	Return Valve (to adjust the liquid direction of dispensing)
③	Titration pipe
④	Titration pipe cover
⑤	Titration pipe Tip
⑥	Bottle Adapter
⑦	Filling pipe

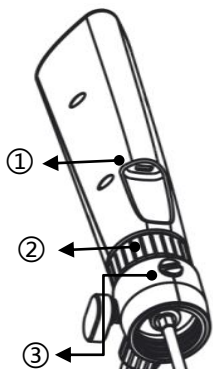

No.	Description
①	Controller Port (Micro USB)
②	Main Body lock
③	Air Admission Cap (pressure balance)

3.2 Remote Control Handle

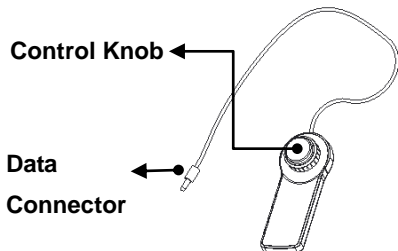

3.3 Controller

Allows for iTrite control and function setting.

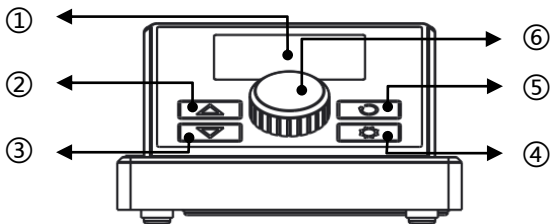

No.	Description
①	LCD Display (show iTrite running state)
②	Filling (press and hold for filling , release it to stop)
③	Dispensing (press and hold for fast titration , release it to stop)
④	Setting/magnetic stirrer (short press switching magnetic stirrer on/off; press and hold 2s into setting interface)
⑤	Pre-Filling (press and hold 2s for piston to complete a aspirating and dispensing process)
⑥	Knob (Turn Knob for dropwise titrating, short press Knob for reset the liquid volume record to zero)

Control Panel can be fully adjustable up to an angle of 45°

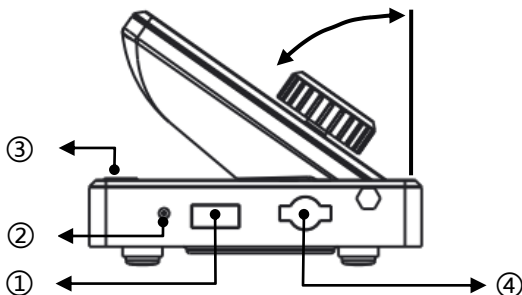

No.	Description
1	Magnetic Stirrer Data Port (USB)
2	Locating Slot (to ensure magnetic stirrer assembly in place)
3	Sensor Holder Assembly Slot
4	Magnetic Stirrer Fastening Slot (to fixation with controller)

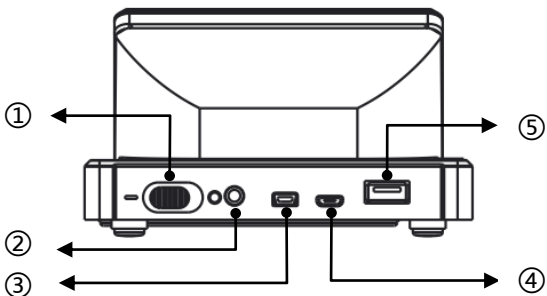

No.	Description
1	Power Switch (symbol "O" indicates Off , "-" indicates On)
2	Remote control handle Port
3	Communication port (non-function)
4	Charging/Communication port
5	Main Instrument Port

3.4 Magnetic Stirrer

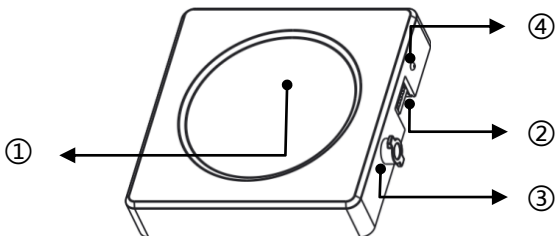

No.	Description
1	Stirring Plate (Max. Bar 20mm)
2	Communication port
3	Fastening key
4	Location key (to ensure magnetic stirrer assembly in place)

3.5 Display

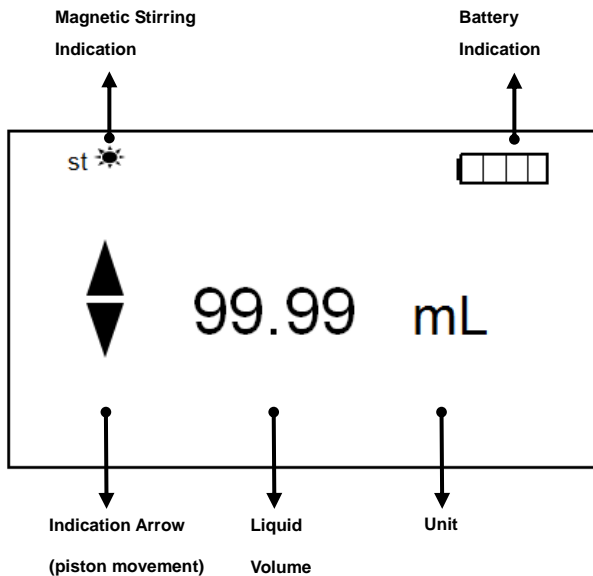

4. Assembly Instruction

Step - 1: Turn the Main Instrument Lock clockwise to connect titrating tip with Main Body.

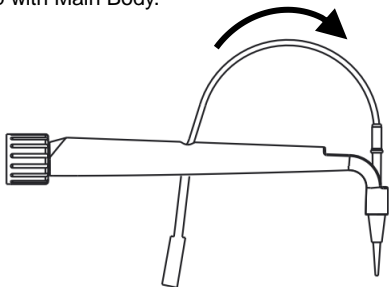

Step - 2: Press the titrating pipe tail end into the location slot.

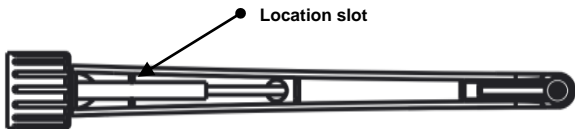

Step - 3: Push the titration pipe tail end with a certain length.

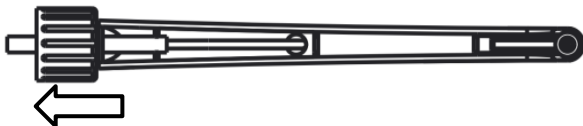

Step - 4: Connect the titration pipe tail end with the Dispensing valve.

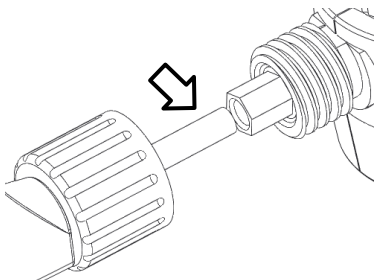

Step - 5: locking the titration pipe.

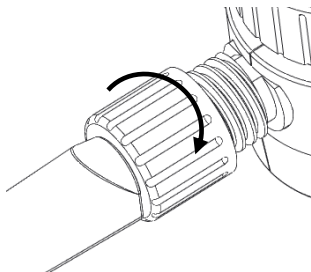

 **CAUTION:** Titrating pipe are made of FEP. Please confirm compatibility prior to use (Refer to chapter 12 “Limitations and Compatibility”).

Step - 6: Connect filling pipe with filling valve.

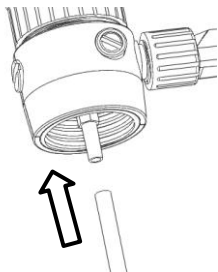

Step - 7: Choose a suitable bottle adapter, then connect it with iTrite main body.

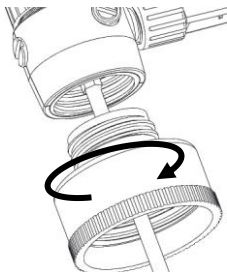

Step - 8: Turn bottle adapter to fasten main body and bottle.

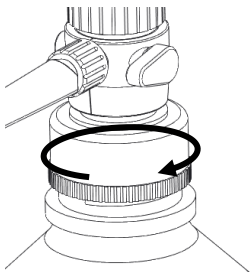

 **CAUTION:**

- ① Please ensure that the adapter is fastened prior to each use.
- ② For perfect titration, please do not move or touch Main Instrument during operation to avoid physical damage to your iTrite.

Step - 9: Use USB cable to connect Main Instrument with Controller.

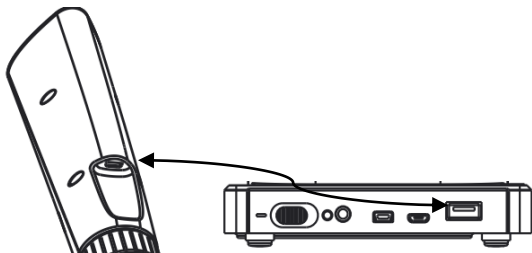

Step - 10: Turn Return Valve to direction ①

If liquid is needed to be emptied from the barrel, turn Return Valve to direction ②.

iTrite basic system was assembled.

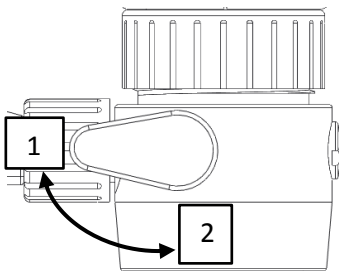

5. Operation





CAUTION: Do a complete process of aspirating and dispensing before the first time work.

5.1 Titration

Step - 1: Power on.

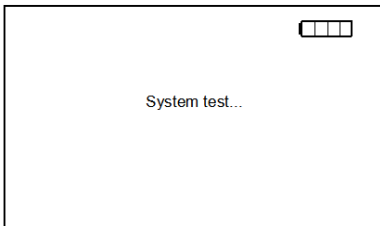
Step - 2: Waiting self-check complete.



Step - 3: Long press **Pre-filling button** () 2 seconds to let air out, leaving the piston at the bottom of the barrel finally.

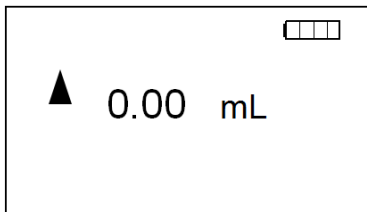

Step - 4: Press and hold **Filling button** () to fill targeted liquid until Indication Arrow showing that the piston is moving downward.

Long press knob 2 seconds, do the same operation also.

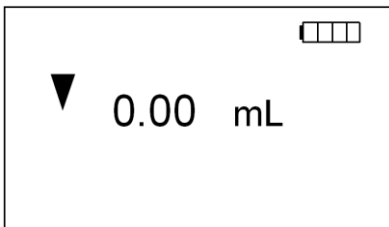

Step - 5: Long press **Dispensing button** ()for fast titration.

Turn Knob for dropwise titrating.

The **dispensing liquid volume** will continue recording and the volume will be shown on the screen.

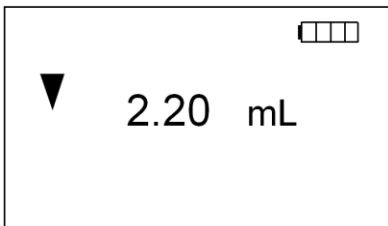

NOTE :

When recorded volume reaches the maximum value of 99.99ml, the instrument will stop. Please press the **knob** to reset Liquid Volume to zero.



CAUTION: There will may be some air bubbles in the barrel during the operation. These bubbles do not affect the actual use.

If the bubble is bigger to affect the actual use, please

aspirate and dispense a few times to purge . If this solution does not work, please contact the manufacturer.

5.2 Liquid Emptying

If liquid is needed to be emptied from the barrel.

Step - 1: Turn Return Valve to direction ②.

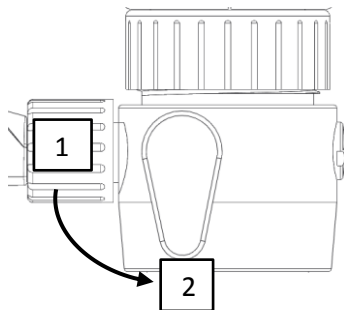

Step - 2: Long press **Dispensing button** (▽), until the piston moves to the bottom of the barrel, emptying the liquid.

Step - 3: Turn Return Valve to direction ①.

Emptying operation is completed.

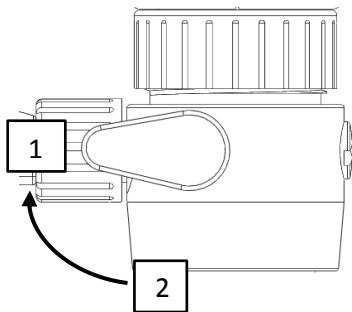

6. Function Setting

Press **Setting button** () for about 2 seconds to enter Function Setting interface.

Press **Setting button** () to flick through modes.

Long press **Setting button** () for about 2 seconds in any mode to exit Function Setting interface.

Page I: Aspiration speed within a range of 1-16. Turn **Knob** to adjust and press for confirmation.

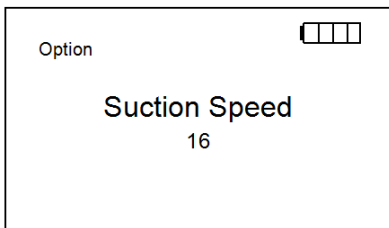

Page II: Dispensing speed within a range of 1-16. Turn **Knob** to adjust and press for confirmation.

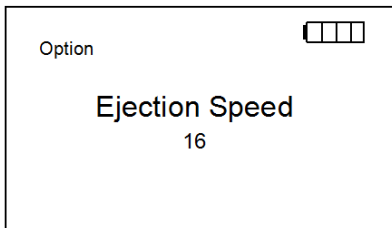

Page III: Magnetic stirrer speed within a range of off-5. Turn **Knob** to adjust and press for confirmation.

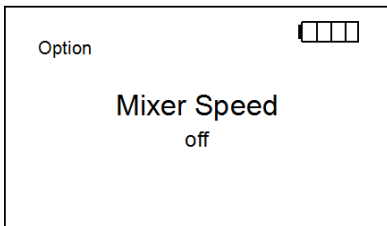

NOTE: This function is effective after connecting the magnetic stirrer only.

7. Accessories

7.1 Remote Control Handle

The Control Handle is fully maps the operation of Control Panel.

Turn Knob for titrating, short press for resetting the liquid volume to zero, long press 2 seconds for filling liquid.

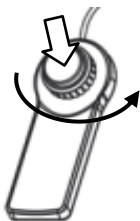

MAX. Length: 90 cm

7.2 Magnetic Stirrer

Magnetic stirrer is convenient for mixing during the titration.

Step - 1: Connect Control Panel Connector with Magnetic Stirrer Connector.

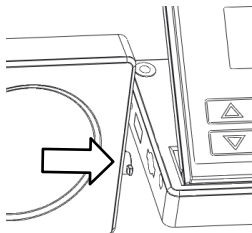

Step - 2: Turn the Magnetic Stirrer into horizontal position until the connectors lock.

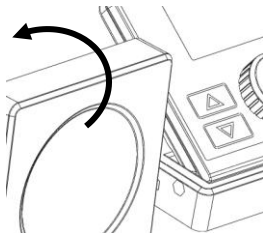

Step - 3: Connect the USB Port under the Magnetic Stirrer with the Control Panel.

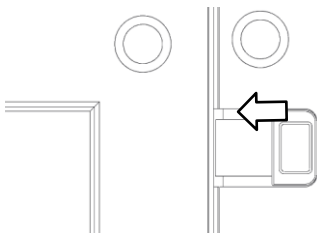

7.3 Assemble Sensor Holder.

Step - 1: Attach the Sensor Holder into place.

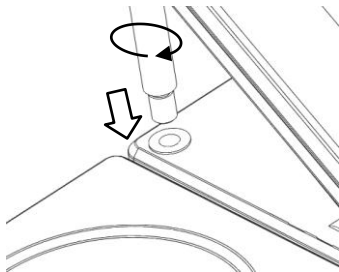

Step - 2: Press the black button of the clamp and release until reaching the appropriate height.

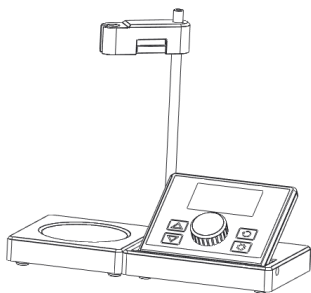
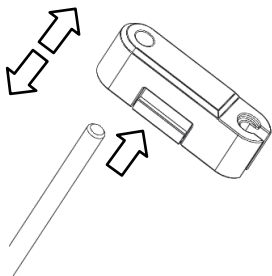

Assembly diagram

7.4 Extended Titrating pipe

Extended titrating pipe can effectively extend the titration distance from the titrator.

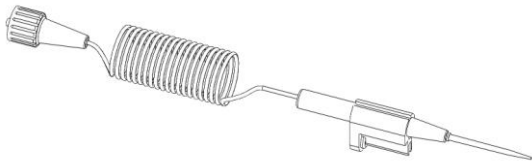

MAX. Length 1.5m

 **CAUTION:**

Titration pipes are made of FEP. Please confirm compatibility prior to use (Refer to chapter 12 “Limitations and Compatibility”).

Step - 1: Connect the titration pipe tail end with the Dispensing valve.

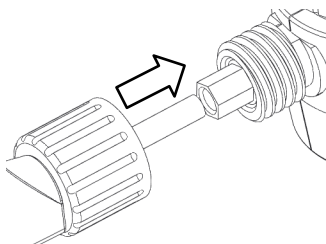

Step - 2: locking the titration pipe.

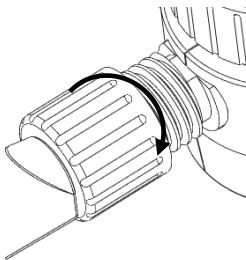

Step - 3: Follow the figure to assemble the adapter and extended titrating pipe.

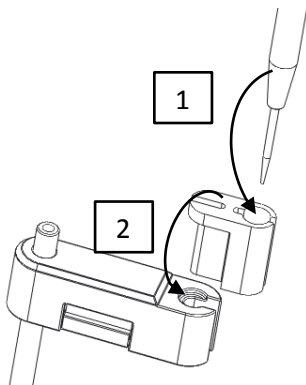

8. Calibration

Calibration should take place at 20-25°C, kept constant within

$\pm 0.5^{\circ}\text{C}$. A dedicated calibration software will write calibration values in your iTrite, after the distilled water has been repeatedly weighed up at least five times.

Hardware needed: :

- Electronic balance with readability of 0.01 mg
- Distilled water
- X86-or X64-architected PC with pre-loaded Windows (XP/Vista / 7/8/10)operating system

Software needed:

- Dedicated calibration software of iTrite
- (For more information, please contact with your nearest distributor.)



CAUTION:

If your iTrite does not work properly after calibration, please contact your nearest distributor for assistance.

9. Cleaning and Maintenance



CAUTION: iTrite cannot be autoclaved.

9.1 Cleaning the Outer Surface

The outer surface of your iTrite is made of ABS, ideal for easy cleaning with simply clean water.

9.2 Cleaning the Barrel

iTrite barrel cleaning is repeatedly inhale row clear water for cleaning.

Aspiration and dispensing at least 5 times, according to user's actual situation to increase or decrease.

To ensure emptying remained in the barrel, the operation reference "liquid emptying"

Step - 1: Turn Return Valve to direction①, long press **Pre-filling** button make the piston stop at the barrel bottom

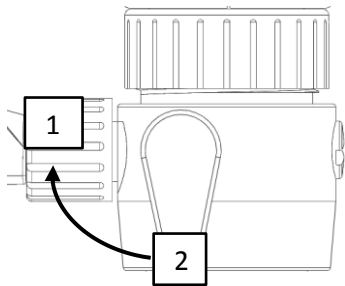

Step - 2: Press **Filling** and **Dispensing** button to aspiration and dispensing simply clean water at least 5 times.

Step - 3: long press **Pre-filling** button make the piston stop at the barrel bottom.

Step - 4: Ensure that into the tube is not submerged in a liquid, Press filling button make piston run to the top of the barrel.

Step - 5: Turn Return Valve to direction②, press Dispensing button make piston run to the bottom of the barrel.

Step - 6: Cleaning work is finish, Turn Return Valve to direction①



CAUTION: User is not recommended to remove and

cleaning of iTrite barrel, if the barrel cleaning operation fail to meet the cleaning requirements of users. please contact the dealer or manufacturer professional services personnel for cleaning.

Ensure iTrite is empty without liquid residue before delivery to service personnel.

9.3 Filling and Dispensing valve Replacement

Use the Installation tools to disassemble the old valve, replace the

new valve to the same position.

Valve has no fixed replacement cycle, problems after the replacement.

The issue that could be has involvement with valve, please checking the “Trouble Shooting”



CAUTION: The following operation must to use

installing tools to do.

Before disassembly, remove the dispensing and filling pipe.

Disassemble Dispensing valve

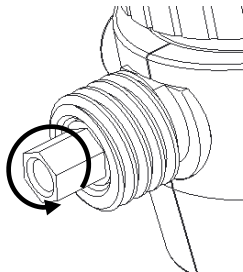

Disassemble Filling valve

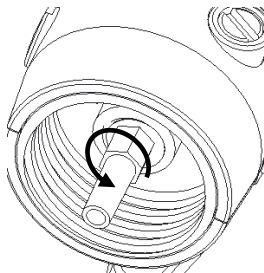

10. Trouble Shooting

Issue	Possible Cause	Solution
-------	----------------	----------

Piston overflows with liquid	Piston wears out.	Contact with manufacturer
Piston moves with difficulty	Piston or its parts are contaminated or damaged due to crystallization and sedimentation.	① Do "Cleaning the Barrel" ② Contact with manufacturer
Failure to filling	Filling valve is clogged.	① Replace filling valve ② Contact with manufacturer
Failure to refill; refilling sucks back into the titration tip.	Dispensing valve is contaminated or titration tip damaged.	
Bubbles in the instrument/ Dispensing volume is less than the volume displayed.	Filling pipe is loose or damaged.	Replace filling pipe
	Filling pipe is away from the liquid.	Chicking filling pipe
	Return pipe is not installed or wrongly	Contact with manufacturer

	installed.	
	The instrument is not fully refilled.	Checking Operation
	Filling valve is clogged or damaged.	Checking filling valve
Replace filling valve		
No display	Battery dead	charging
	Connection fail	USB cable connection checking

11. Storage

During storage periods at constant temperature and humidity,

the recommended temperature range is from 0-40°C and humidity no more than 80%.

Please every month to charging for iTrite if being unused in long time , make sure there are 50% power in battery at least.

12. Warranty

iTrite electronic titrators are covered by one-year warranty against defects in workmanship and materials. Please contact us or your nearest distributor.

ANY WARRANTY WILL, HOWEVER, BE DEEMED AS VOID WITH NORMAL WEAR AND TEAR OR FOR OPERATIONS CONTRARY TO THE INSTRUCTIONS GIVEN IN THIS MANUAL.

Each and every iTrite has been calibrated and tested in compliance with ISO8655-6 / DIN12650 when manufactured, ensuring safe and comfortable operation.

13. Limitations and Compatibility

It is recommended to confirm reagent's compatibility with this

instrument when applied for special purposes, trace analysis for example.

- The liquid-path construction of your iTrite is made of borosilicate glass, FEP and PTFE. Do not apply it in handling liquids like hydrofluoric acid.
- The instrument would be clogged or damaged by solid particles in turbid liquid like activated carbon.
- The plastic parts of your iTrite would be in swelling condition if concentrated acid and alkaline, and methylbenzene, benzene and other nonpolar organic solvents are put into use.
- Keep your iTrite away from the highly combustible carbon disulfide.
- iTrite cannot be autoclaved.
- Do not put your iTrite in contact with corrosive gas like HCL smog.

Compatibility (Max. Conc. 1 mol/L)

Acetic acid

Alcoholic potassium hydroxide solution
Ammonium iron (II) sulfate solution
Ammonium thiocyanate solution
Barium chloride solution
Bromide bromate solution
Cerium (IV) sulfate solution
EDTA solution
Hydrochloric acid
Hydrochloric acid in Acetone
Iodine solution*
Iodide Iodate solution*
Iron (II) sulfate solution
Nitric acid
Oxalic acid solution
Perchloric acid
Perchloric acid in glacial acetic acid

Potassium bromate solution
Potassium bromate bromide solution
Potassium dichromate solution
Potassium hydroxide solution
Potassium iodate solution
Potassium permanganate solution*
Potassium thiocyanate solution
Silver nitrate solution*
Sodium arsenite solution
Sodium carbonate solution
Sodium chloride solution
Sodium hydroxide solution
Sodium nitrite solution
Sodium thiosulfate solution
Sulfuric acid
Tetra-n-butylammonium hydroxide sol.

Triethanolamine in Acetone*
Zinc sulfate solution

 **CAUTION:** This compatibility is against parts which are directly in contact with liquid, if any of above solution needs to be applied, contact with manufacturer for consultation.