

IT

ISTRUZIONI DI SICUREZZA

- L'apparecchio dovrà essere installato, collegato e testato da un elettricista qualificato, nel rispetto delle normative vigenti.

- Spegnerel'alimentazione prima dell'istallazione o della manutenzione dell'apparecchio ed assicurarsi che i cavi non siano schiacciati o danneggiati da oggetti taglienti.

- L'apparecchio non deve essere coperto con materiale isolante o simili.

- Pulire l'apparecchio con un panno morbido e utilizzare un comune detergente a PH neutro. Le superfici in acciaio inossidabile devono essere mantenute con regolarità.

- Eventuali alterazioni o modifiche dell'apparecchio renderanno nulla la garanzia. Il produttore è libero di cambiare il design, le specifiche tecniche e le istruzioni di montaggio.

EN

SAFETY INSTRUCTIONS

- The appliance should be installed, connected and tested by qualified electrician, and in accordance with local regulations.

- Turn off the power supply before installation or maintenance of the appliance, and make sure that the cables will not be squeezed or damaged by sharp edges.

- The appliance should not be covered by insulation blankets or similar materials.

- Clean the appliance with a soft cloth and a standard PH neutral detergent. Stainless steel surfaces should be maintained regularly.

- Misuse of, or changes to the appliance shall nullify the guarantee. The manufacturer is free to change the design, specifications and instructions for assembly.



Facebook



Instagram



WhatsApp

FLUA S. R. L.
BASTIONI DI PORTA VOLTA 7,
MILANO, ITALY CAP 20121
TEL: +39-3927778888
FAX: +39-0236728301
E-MAIL: INFO@FLUA.COM
WWW.FLUA.COM

CN

安全指导

- 产品应在专业作业人员的指导下进行安装、连接和测试,并符合当地法规。

- 产品进行安装或维修时,需关掉所有电源,并保证电线无任何挤压或破坏。

- 灯具表面不能被隔热棉或其他类似物料覆盖。

- 用于净柔软的布和标准的中性清洁剂来清洁产品表面,不锈钢表面需定期维护。

- 滥用,或更改产品,则保质期无效,制造商有权更改设计、规格和安装说明。

弗洛中国运营中心
深圳宝安宗泰文创产业园B11栋
服务热线: 400-0750-678
邮箱: INFO@FLUA.COM
(如对安装或售后有疑问, 欢迎致电)



公众号
WeChat



官网
Website

FLUA®
PERFORM YOUR LIGHT

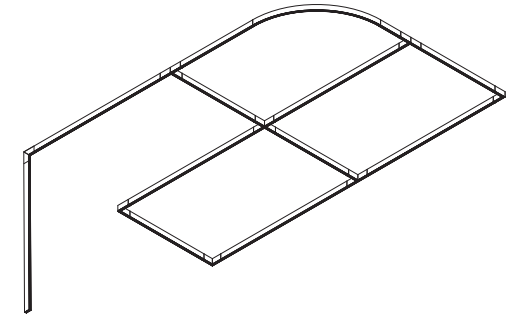

Installation Instruction

MODEL: ULTRA ON

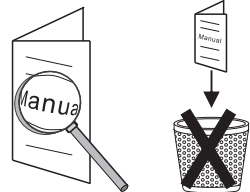

DIY Design

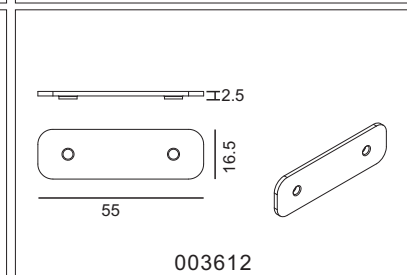
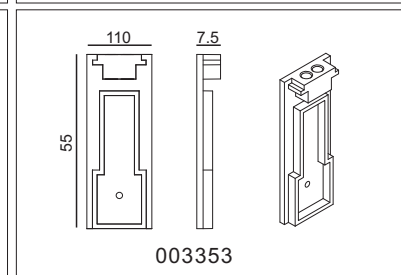
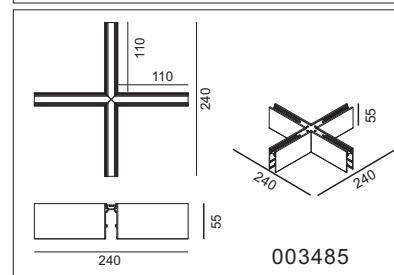
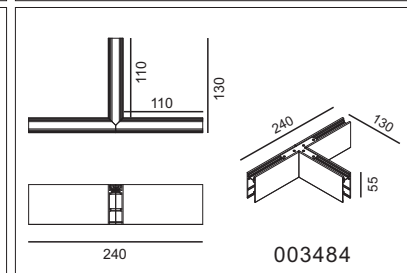
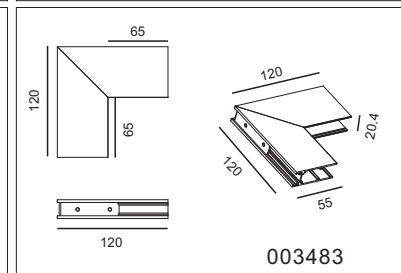
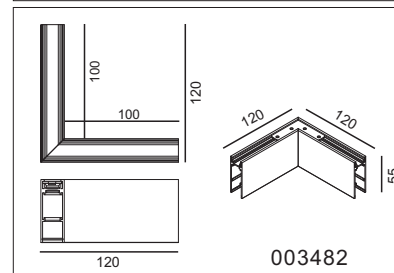
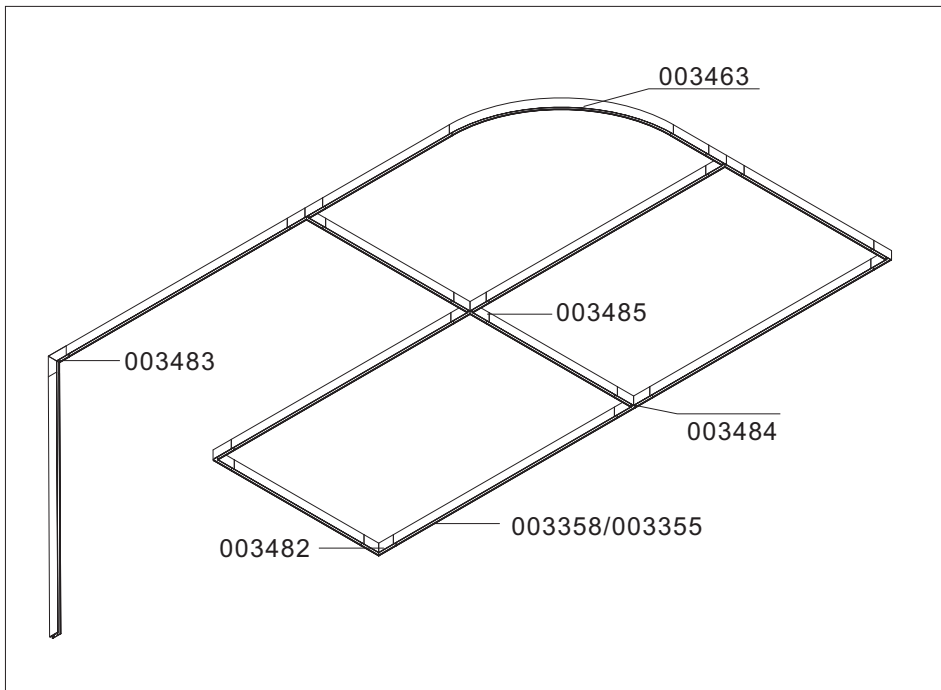
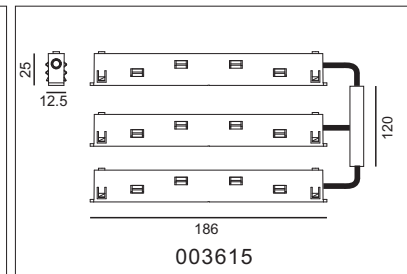
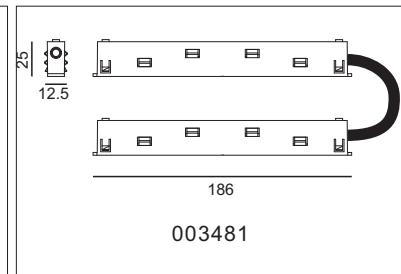
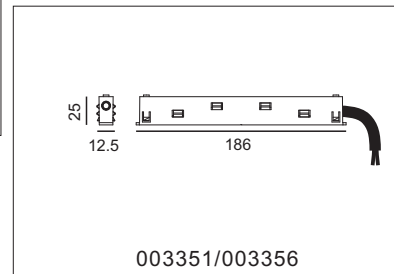
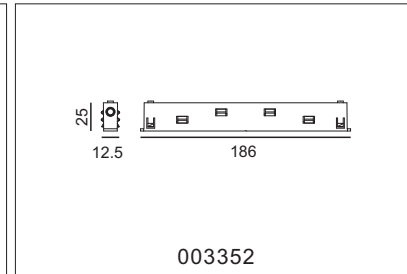
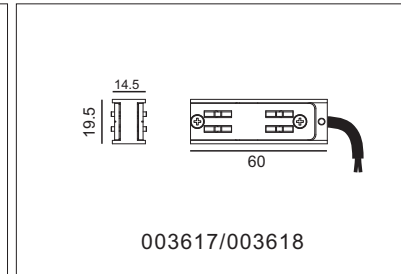
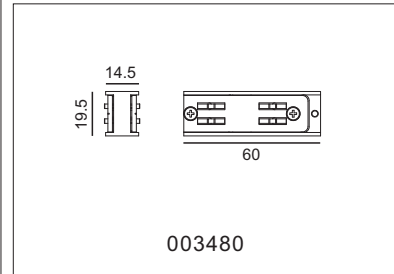
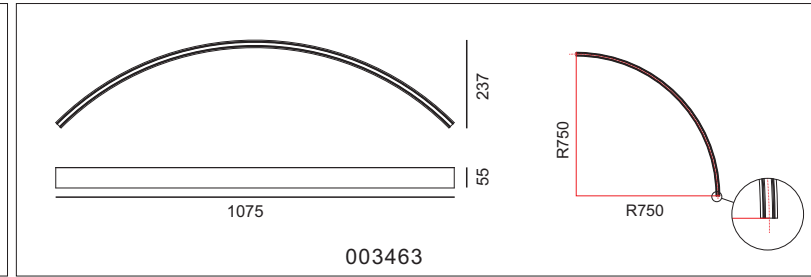
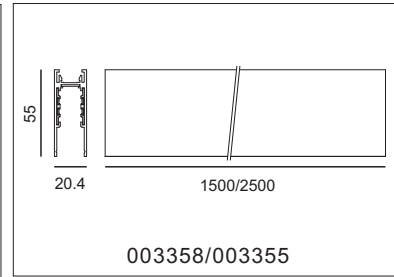
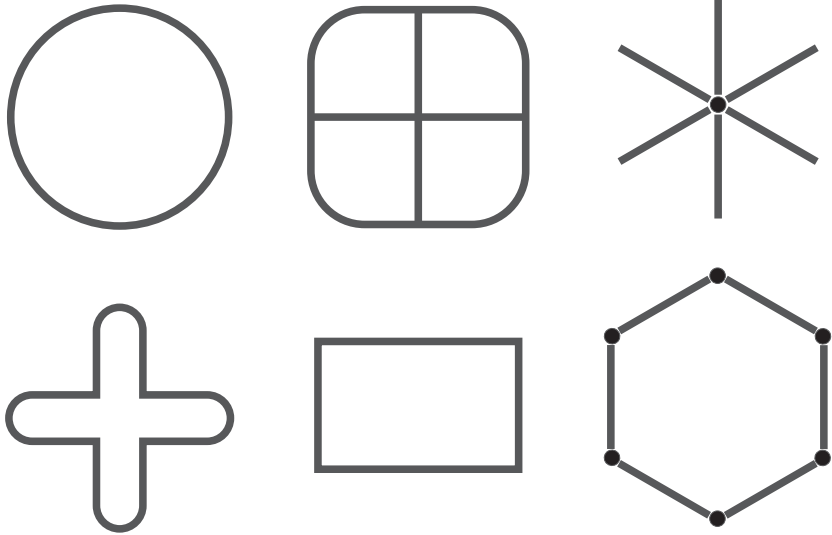

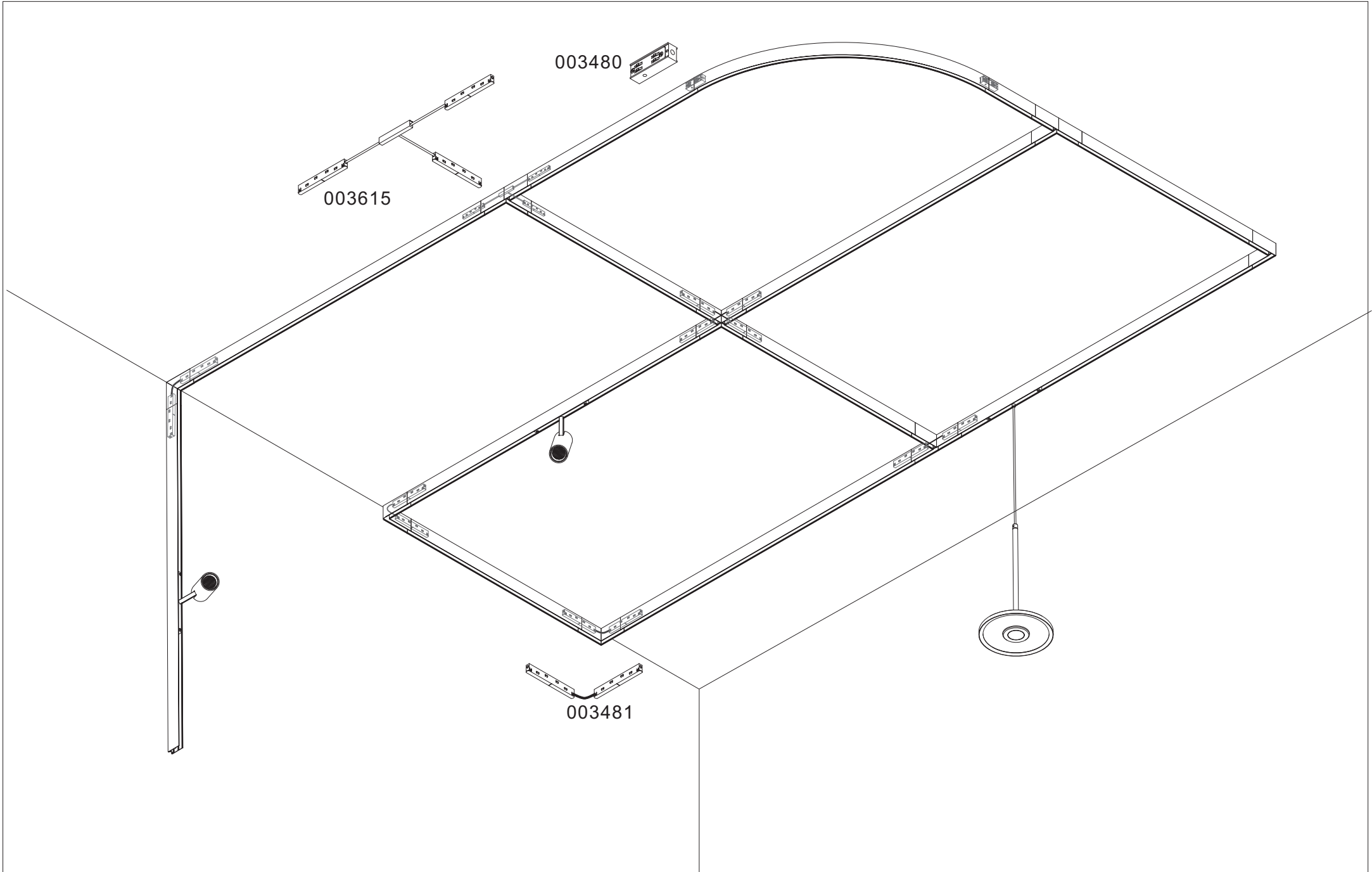

1

WARNING:
It can be cut to length
and angle you want

Accessory Set
1.5mm

2

It is recommended to install the power supply
next to the power box or the maintenance port.

100-240V AC

48V DC
" + " Red
" - " Black

MAX. 0.75mm²
MAX. 350W(48V)

20 Ø8 Ø3.5 1000 1000

3

003353 x2

003351/003356

4

003353 x2

5 *hole pattern*

1000 1000 1000 1000

6

MAX. 350W(48V)

003352

7a

003358/003355

003617/003618
003480

003617/003618
003480

003358/003355

003358/003355

7b 003463

003463

003617/003618
003480

003617/003618
003480

