

# MUJI

無印良品



**Bedding**  
Australian Edition



---

# Bedding

---

## Contents

Bed Sizing Comparison	106
Wooden Frame Bed	108
Oak Wooden Bed	109
Rubberwood Wooden Bed	111
Mattress with Legs	112
Mattress Care	113
Mattress	115

 Products with parts sold separately

 Assembly type + assembly time (minutes)

 Can be assembled by one person

 Can be assembled by 2 or more people

 Extra tools required

MUJI RETAIL (AUSTRALIA) PTY LTD

Published November, 2023.

All item information, prices and inventory are may be subject to change.

Images are for reference only.

# Bed Sizing Comparison

Please note that MUJI bedding products use standard Japanese mattress measurements. Please use the comparison chart below for reference if you are planning to use Australian Standard sized products with MUJI items.

—— Australian Standard  
----- MUJI

## Single

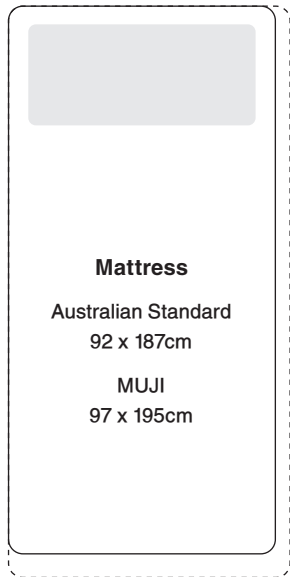

**Fitted Sheet**  
Australia 91 x 190 x 40cm  
MUJI 100 x 200 x 18-28cm

**Duvet Cover**  
Australia 140 x 210cm  
MUJI 150 x 210cm

## Double

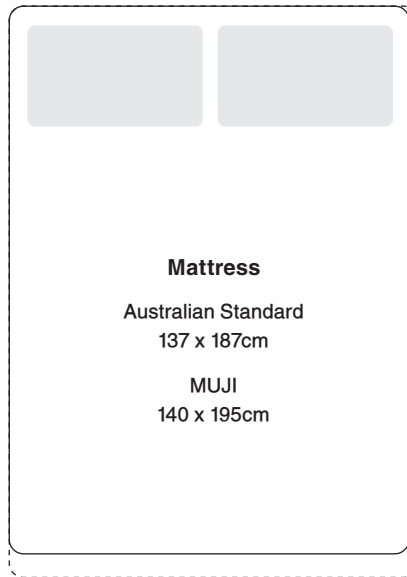

**Fitted Sheet**  
Australia 137 x 193 x 40-50cm  
MUJI 140 x 200 x 18-28cm

**Duvet Cover**  
Australia 180 x 210cm  
MUJI 190 x 210cm

## Queen

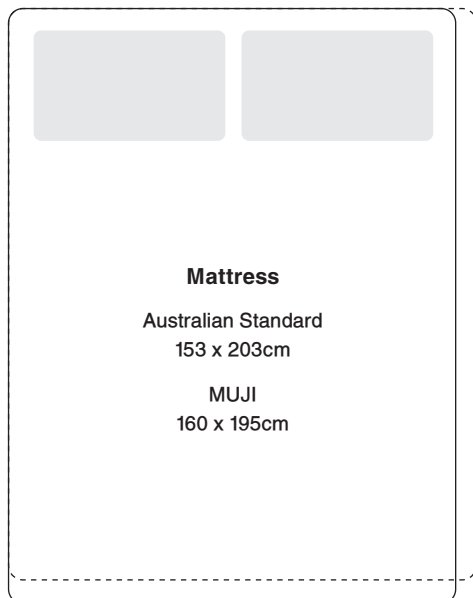

**Fitted Sheet**  
Australia 152 x 203 x 40-50cm  
MUJI 160 x 200 x 18-28cm

**Duvet Cover**  
Australia 210 x 210cm  
MUJI 210 x 210cm

## King

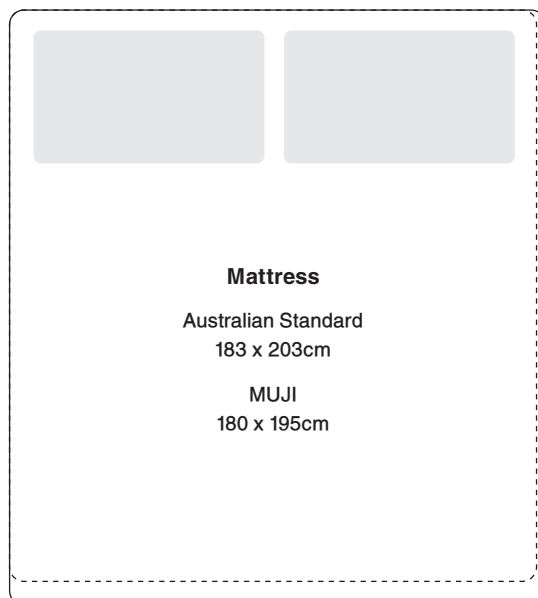

**Fitted Sheet**  
Australia 180 x 203 x 40-50cm  
MUJI 180 x 200 x 18-28cm

**Duvet Cover**  
Australia 245 x 210cm  
MUJI 230 x 210cm





# Wooden Bed Frame

People wish for uniquely different characteristics in beds, which is natural for equipment that people spend a lot of time on. More storage space, using two single-sizes side-by-side and a better ventilation, to name a few preferences. MUJI's modular Bed Frame was born from such customer feedback.

The headboard is designed so that two beds can be seamlessly placed next to each other. The bed frame provides space underneath for storage. MUJI developed its new bed for the comfort of users during sleep and in daily life.

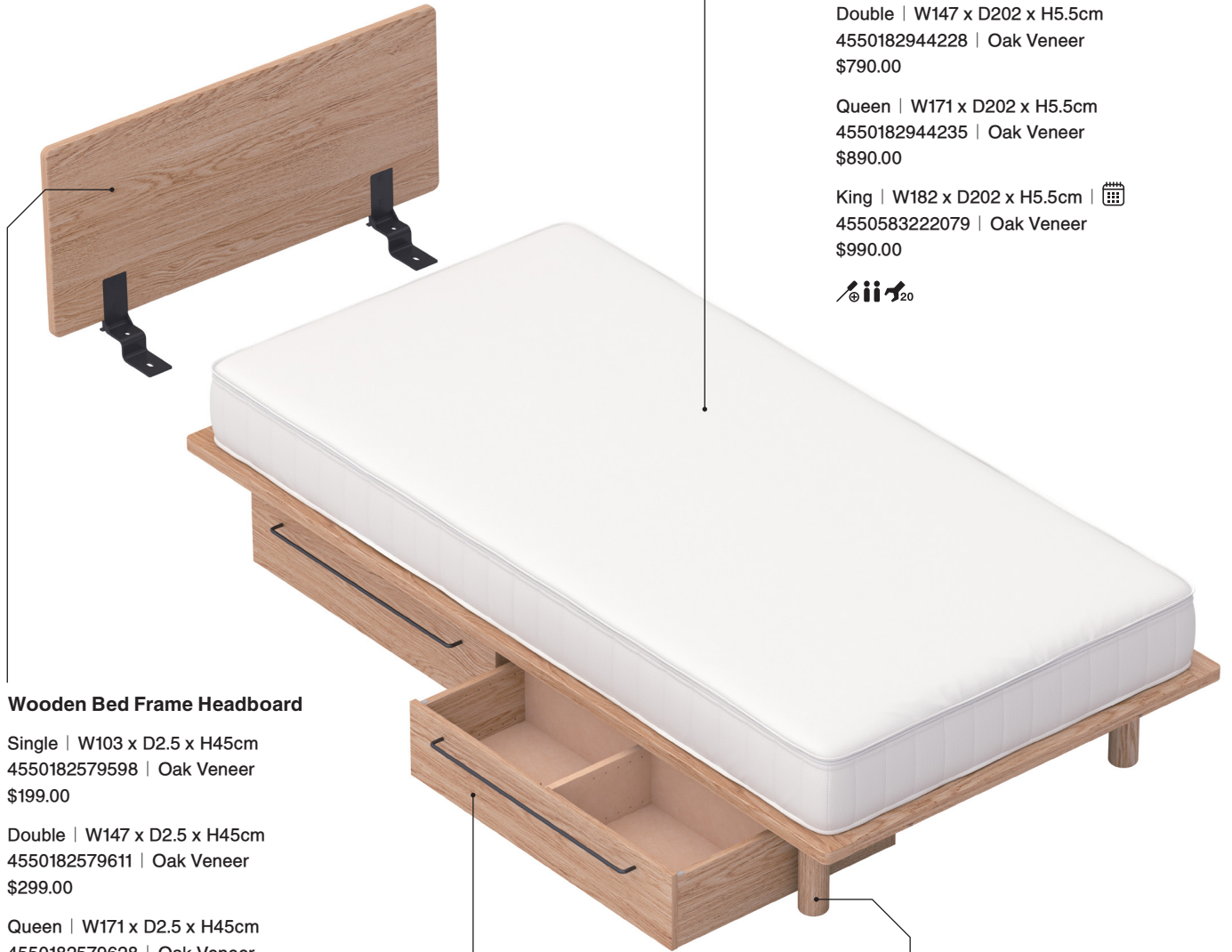

## Wooden Bed Frame

Single | W103 x D202 x H5.5cm  
4550182944204 | Oak Veneer  
\$590.00

Double | W147 x D202 x H5.5cm  
4550182944228 | Oak Veneer  
\$790.00

Queen | W171 x D202 x H5.5cm  
4550182944235 | Oak Veneer  
\$890.00

King | W182 x D202 x H5.5cm |   
4550583222079 | Oak Veneer  
\$990.00



## Wooden Bed Frame Headboard

Single | W103 x D2.5 x H45cm  
4550182579598 | Oak Veneer  
\$199.00

Double | W147 x D2.5 x H45cm  
4550182579611 | Oak Veneer  
\$299.00

Queen | W171 x D2.5 x H45cm  
4550182579628 | Oak Veneer  
\$349.00

King | W182 x D2.5 x H45cm |   
4550182579635 | Oak Veneer  
\$399.00



## Bed Frame | Underbed Storage | L | Oak

W80 x D90.5 x H19cm  
4550002554019 | Oak | H19cm  
\$249.00

W80 x D90.5 x H25cm  
4550002550929 | Oak | H25cm  
\$299.00



## Wooden Bed Frame Leg | Oak

4550002529444 | 26cm | Set of 4  
4550002528355 | 20cm | Set of 4  
4550002529406 | 12cm | Set of 4

\$39.95

Please note 12cm legs cannot be used for Queen and King bed frames.

\*Mattress is sold separately.



## Oak Wooden Bed

With a simple and basic design, the bed fits well in any room. Ample under the bed storage space is available thanks to 30cm height legs. You can fully utilise the space by adding under-bed storage boxes.



### Wooden Bed | Oak Veneer

W83 x D201.5 x H74 cm  
4550182944495 | Single  
\$490.00

W143 x D201.5 x H74cm  
4550182944518 | Double  
\$690.00

W163 x D201.5 x H74cm  
4550182944525 | Queen  
\$790.00

W183 x D201.5 x H74cm  
4550182944532 | King | 📅  
\$890.00



### Wooden Bed Storage Box with Partitions

W94.5 x D62.5 x H18.5cm  
4550344303986 | Oak Veneer  
\$149.00



\*Mattress is sold separately.







## Rubberwood Wooden Bed

Our Rubberwood Wooden Bed range is crafted sustainably by using the leftover wood from collecting rubber sap. With a simple and basic design, the bed fits well in any room. You can fully utilise the space by adding under-bed storage boxes.



### Rubberwood Wooden Bed

Single | W83 x D201.5 x H74 cm  
4550583435301 | Rubberwood Veneer  
\$490.00

Double | W143 x D201.5 x H74cm  
4550583435332 | Rubberwood Veneer  
\$690.00

Queen | W163 x D201.5 x H74cm  
4550583435349 | Rubberwood Veneer  
\$790.00

King | W183 x D201.5 x H74cm |   
4550583460983 | Rubberwood Veneer  
\$890.00



### Wooden Bed Storage Box with Divider

W94.5 x D62.5 x H18.5cm  
4550583435318 | Rubberwood Veneer  
\$149.00



\*Mattress is sold separately.

# Mattress with Legs

This bed was born from a meticulous pursuit of sleeping comfort and quality materials.



### High Density Pocket Coil Mattress with Legs | Steel frame

Single  
W98 x D198 x H26cm  
4550002970659  
\$690.00

Double  
W140 x D198 x H26cm  
4550344884904  
\$990.00

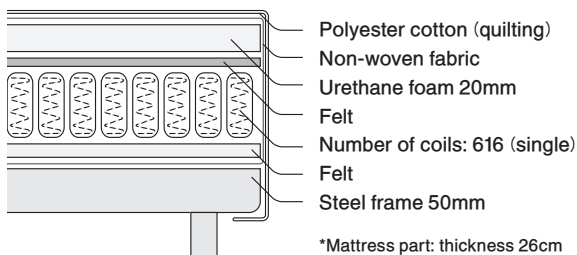

### Wooden Bed Frame Leg | Oak

4550002529444 | 26cm | Set of 4  
4550002528355 | 20cm | Set of 4  
4550002529406 | 12cm | Set of 4  
\$39.95

**Cover (side fabric)/Coil Units can be replaced**

The legs, steel frame, and coil unit can be separated and wrapped in a cover (side fabric) with removable tape. We also sell parts only, so if you replace worn parts or dispose of them separately, you can reduce the burden on the environment.



**Pocket coil springs are arranged in a well-balanced manner**

A slightly harder coil is used around the waist where it tends to get tired, an even harder coil is used around the edges where you sit a lot, and a softer coil is used in the wider area that accommodates your body. Three types of hardness are arranged depending on the role.

\*Pocket coil only

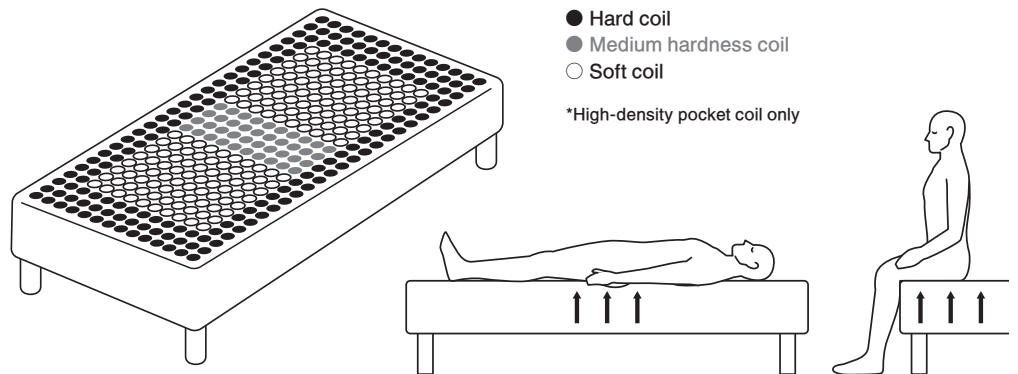

**Mattress rotation possible**

Rotate the head and legs regularly throughout the season. If the load on the coil is concentrated on one point, the strength of the spring will weaken, so by applying the load evenly, you can remove the burden on the coil. Also, be sure to regularly prop up the mattress to ventilate it. If left on the floor, moisture will accumulate and cause a breeding ground for mold.

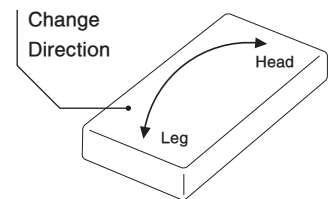

**About under-floor storage for mattresses with legs**

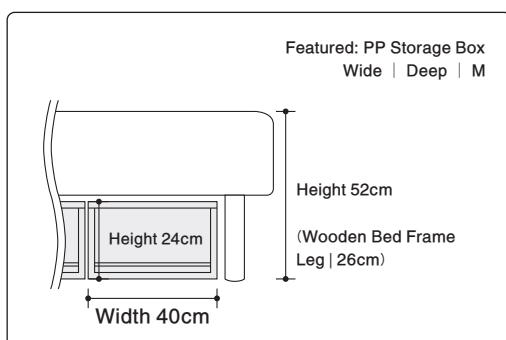
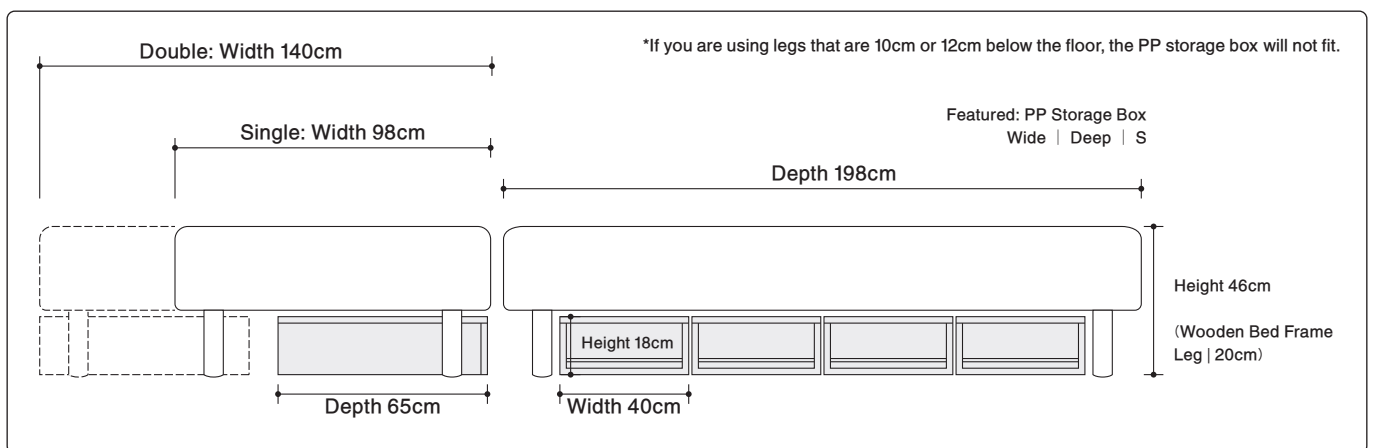





# Mattress

The High Density Pocket Coil Mattress range is constructed with a dense arrangement of coils for comfort and balanced support.



### High-density Pocket Coil Mattress/Washable Cover

4550344502938 | Single  
\$990.00

4550344502952 | Double  
\$1390.00

4550344502969 | Queen  
\$1590.00

4550344502976 | King | 📅  
\$1790.00

## Constructed with a dense arrangement of coils for comfort and balanced support.

### Moderate Firmness

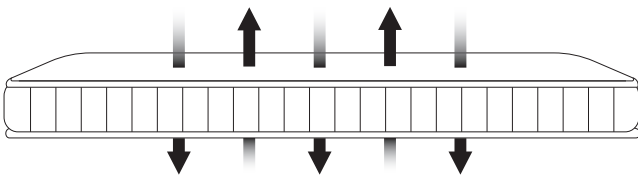

Constructed with multiple layers to create a comfortable mattress with moderate firmness. Breathable cover fabric is quick to dry.

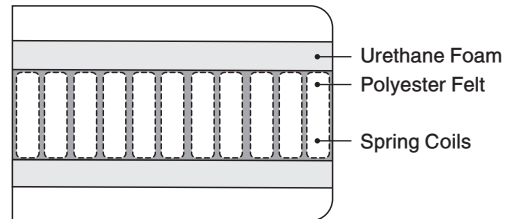

Diameter: **1.6mm** Height: **180mm**  
When inserted into the non-woven fabric case: 140mm

### Balanced Support

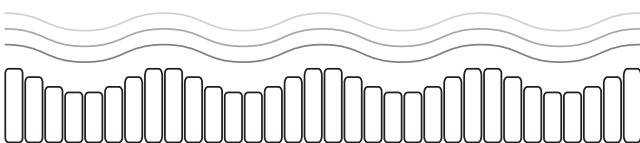

The coil structure conforms to the shape of your body, absorbing weight and reducing the pressure on the spine and lower back.

### Coil Arrangement

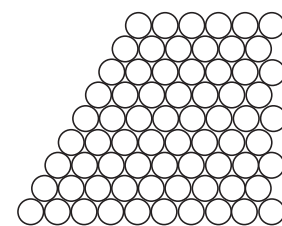

Single: 25x32mm  
800 pcs  
Double: 36x32mm  
1152 pcs  
Queen: 42x32mm  
1344 pcs  
King: 48x32mm  
1536 pcs









# MUJI

無印良品

## **Emporium**

269/321 Lonsdale Street,  
Melbourne VIC  
(03) 9671 4974

## **Chadstone**

Shop B151/1341 Dandenong Road,  
Malvern East VIC  
(03) 9563 3558

## **The Galleries**

500 George Street,  
Sydney NSW  
(02) 8036 4556

## **Chatswood**

Shop 482/1 Anderson Street,  
Chatswood NSW  
(02) 8459 7786

[mujaustralia.com](http://mujaustralia.com)