



Nite Ize Directory



TABLE OF CONTENTS

RUNOFF WATERPROOF PROTECTION	3
- TRAVEL	4
- MOBILE	6
MOBILE & TABLET	7
- STEELIE® KITS	8-9
- BIKE MOUNTS	10
- ACCESSORIES	12
HARDWARE	13
- TIE DOWNS & BUNGEEES	14-15
- GEAR TIES®	16-19
- CARABINERS	19-20
EVERYDAY & GIFT	21
- KEY ACCESSORIES & MULTI-TOOLS	22-27
- FINANCIAL TOOL®	28
- ILLUMINATION	29-31
PET	32
- ACCESSORIES	33
- ILLUMINATION	33-35



WE STAND BEHIND
OUR PRODUCTS
100%

With our Worry Free Guarantee™, customers know that if they are dissatisfied with a product's performance, we will always make it right.



RUNOFF WATERPROOF PROTECTION

TRAVEL
MOBILE

RUNOFF® WATERPROOF TRAVEL POUCH

Protect and organize your gear, devices, and travel must-haves while keeping accessibility quick and simple. The clear, front window allows for easy item identification and device use, while the flat pouch design makes it easy to slide into bags, backpacks, and carry-ons.

FEATURES

- Features TRU® Zip waterproof zipper
- Tested waterproof to IP67 (withstands immersion in water 1m deep for up to 30min)
- Defends against water, dust, and sand
- Keeps water out. Seals messes in.
- Integrated anchor points for versatile carrying options
- Interior Dimensions: Small: 6.8" (172 mm) x 5.4" (138 mm)
Medium: 8" (203mm) x 7" (178mm)



CODE

ROFS-09-R3
ROFM-09-R3

SMALL
MEDIUM

COLOUR

CHARCOAL
CHARCOAL

RUNOFF® WATERPROOF TOILETRY BAG

Protect your luggage from leaks and messes with the Waterproof Toiletry Bag. Waterproof and durable, this bag fits full-size toiletries and its wide-mouth design and easy-hang handle ensure the contents are easily accessible.

FEATURES

- Features TRU® Zip waterproof zipper
- Tested waterproof to IP67 (withstands immersion in water 1m deep for 30 min)
- Durable TPU with welded construction
- Defends against water, dust, and sand
- Keeps water out. Seals messes in.
- Interior Dimensions:
5" (128mm) x 9.5" (242mm) x 3.4" (87mm)



CODE

ROT-09-R8

COLOUR

BLACK

RUNOFF® WATERPROOF PACKING CUBE

RunOff packing cubes fit perfectly in luggage or carry-ons. Designed for everything from beach trips to business travel, these compressible, airtight, and waterproof bags keep water out and seal messes in.

FEATURES

- Features TRU® Zip waterproof zipper
- Tested waterproof to IP67 (withstands immersion in water 1m deep for 30 min)
- Durable TPU with welded construction
- Defends against water, dust, and sand
- Compresses bulky items
- Interior Dimensions: Small: 5" (126mm) x 6.9" (175mm) x 3.2" (81mm) Medium: 6.9" (176mm) x 10.3" (262mm) x 3.2" (81mm) Large: 10" (254mm) x 14" (356mm) x 3.2" (81mm)



CODE

ROCS-09-R3
ROCM-09-R8
ROCL-09-R8

SIZE

SMALL
MEDIUM
LARGE

COLOUR

CHARCOAL
CHARCOAL
CHARCOAL



RUNOFF® WATERPROOF PHONE POUCH

Keep your phone secure, accessible, and protected from water and sand at the beach, on the boat, or at the waterpark. Clear, touchscreen friendly material allows use of apps and front/back camera.

FEATURES

- Features TRU® Zip waterproof zipper
- Tested waterproof to IP67 (withstands immersion in water 1m deep for 30 min)
- Touchscreen friendly
- Take pictures underwater with front/back cameras
- Includes adjustable, detachable lanyard
- Fits most phone sizes
- Interior Dimensions: 166mm x 86mm x 14mm

CODE: ROPPL-09-R8 ■■■ CHARCOAL

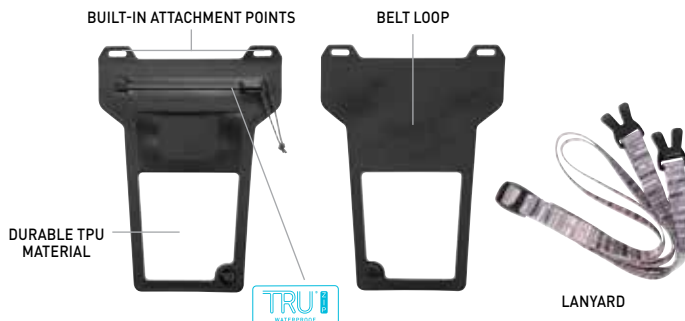

RUNOFF® WATERPROOF PHONE CASE

This unique soft case protects phones from water and sand with a slim design that fits in pockets or can be attached to the included lanyard. Clear, touchscreen friendly material allows use of apps and front/back camera.

FEATURES

- Features TRU® Zip waterproof zipper
- Tested waterproof to IP67 (withstands immersion in water 1m deep for 30 min)
- Touchscreen friendly
- Take pictures underwater with front/back cameras
- Includes internal card/key holder and detachable lanyard
- Fits most phone sizes
- Interior Dimensions: 169mm x 98mm x 18mm

CODE: ROPC-09-R8 ■■■ CHARCOAL



RUNOFF® WATERPROOF TABLET CASE

Protect tablets from water, sand, and dirt with this clear, touchscreen friendly case. Allows use of camera and features a versatile lanyard that can be attached in multiple ways.

FEATURES

- Features TRU® Zip waterproof zipper
- Tested waterproof to IP67 (withstands immersion in water 1m deep for 30 min)
- Touchscreen friendly
- Take pictures underwater
- Includes adjustable, detachable lanyard
- Fits most tablet sizes
- Interior Dimensions: 260mm x 194mm x 18mm

CODE: ROTC-09-R3 ■■■ CHARCOAL





MOBILE & TABLET

STEELIE®

BIKE MOUNTS

ACCESSORIES

STEELIE® ORBITER® VENT KIT 360° MAGNETIC MOUNT

This powerful magnetic phone mounting system allows you to easily attach, detach, and rotate your phone on the portable Vent Mount. The low-profile metal plate adheres to your phone or case, creating a strong magnetic connection with the Orbiter Magnetic Socket.

FEATURES

- Orbiter Magnetic Socket uses a powerful neodymium magnet for a secure hold between the Vent Mount and metal plate
- Silicone center of Orbiter Magnetic Socket and Vent Mount shape allow smooth adjustment and rotation for the perfect viewing angle
- Low-profile metal plate attaches to phone or case using 3M® 300LSE adhesive
- Portable Vent Mount easily clips and unclips from any vehicle vent without tools



VENT MOUNT

ORBITER
MAGNETIC SOCKET

METAL PLATE

CODE: STOVK-01-R8

STEELIE® VENT MOUNT

The Steelie Vent Mount Component is a brilliant solution for keeping your smartphone secure and visible when you're in the car - any car.

FEATURES

- Compatible with Steelie Magnetic Phone and Tablet Sockets, and FreeMount Bracket
- Cam locking lever securely grips the device to nearly any vehicle vent
- Clip & Go - Steelie Vent Mount features an easy-to-use universal clip that attaches & detaches from nearly any vehicle vent - no tools required



CODE: STVM-11-R7

STEELIE® WINDSCREEN MOUNT

The Windshield Mount features an adjustable aluminum arm and suspended Steelie ball design. The adjustable arm can be easily secured to match the angle of your windshield, while the round shape of the Steelie ball allows for endless viewing angles of your device.

FEATURES

- Windshield Mount has adjustable aluminum arm with suspended Steelie ball design
- Windshield Mount uses patented suction cup design for ultimate holding power
- Windshield Mount features suction cup with lever for reinforcement/quick release

CODE: STWS-01-R8



STEELIE® ORBITER® MAGNETIC SOCKET & METAL PLATE

The Orbiter Magnetic Socket component attaches to Steelie mounts using a powerful neodymium magnet and silicone center for a secure connection and smooth glide.

FEATURES

- Orbiter Magnetic Socket is compatible with all Steelie mounts
- By combining magnetic strength with a high-friction phone docking surface, phones stay confidently attached to the Orbiter magnetic phone mounting system
- Low-profile metal plate attaches to phone or case using 3M® 300LSE adhesive
- Includes: Orbiter Magnetic Socket, Metal Plate

CODE: ST0-01-R7



STEELE® ORBITER® PLUS MAGNETIC SOCKET & METAL RING

iPhone 12 users can seamlessly enjoy the power of Steelie mounts with their Apple MagSafe iPhones and cases, instantly connecting their phone to the Magnetic Socket. To stay mounted while charging, users can adhere the included Metal Ring to back of their MagSafe Charger.

FEATURES

- For Apple MagSafe iPhones and accessories
- Magnetic Socket aligns with magnets inside MagSafe phone, case or charger
- Metal Ring adheres to back of MagSafe charger with included 3M® adhesive, allowing for charging while mounted
- Compatible with any Steelie mount
- Requires Steelie mount to complete the system, sold separately
- SAFE FOR USE WITH PHONES - The powerful magnet will NOT damage your phone - however, do not place it near magnetically sensitive objects such as credit cards, computer hard drives, or pacemakers

CODE: STOMS-01-R8



SQUEEZE ROTATING ROTATING SMARTPHONE BAR MOUNT

Expand your Steelie Ecosystem with these versatile components. Already have a Steelie Magnetic Socket on your device? Check out our mounting solutions that allow you to dock your phone around the house, at work, and on the go. Already have a Steelie mount, but want to use more devices with it? No problem, we offer a wide variety of magnetic solutions to attach your favorite devices to your existing Steelie mounts.

FEATURES

- Windshield Mount has adjustable aluminum arm with suspended Steelie ball design
- Windshield Mount uses patented suction cup design for ultimate holding power
- Windshield Mount features suction cup with lever for reinforcement/quick release

CODE: SUSBM-04-R3



WRAPTOR™ ROTATING SMARTPHONE BAR MOUNT

The Wraptor offers edge-to-edge screen visibility while holding phones securely, even over rough terrain. Designed to quickly attach and detach from the bar, the base easily rotates between landscape and portrait modes for maximum viewing adjustability.

FEATURES

- Universal design is compatible with most handlebars, stroller handles, grocery carts, and more
- Durable silicone harness fits even the largest phones, with or without a case
- Securely holds phones in place, on and off road
- Unique design allows quick-and-easy 360° rotation of phone

CODE: WPT-09-R3



FLIPOUT® HANDLE + STAND

The slim and sleek FlipOut attaches with strong 3M® VHB® adhesive for a hold you can trust. Creates a convenient, low-profile handle and stand for devices.

FEATURES

- Creates secure, ergonomic grip for devices
- Stand works in landscape and portrait modes
- FlipOut features 3M® VHB® adhesive for secure attachment
- Durable stainless steel

CODE: FL02-11-R7



CASHBACK® PHONE WALLET

Carry only what you need by keeping your most important cards right on your phone. Attaches to phone or case using strong 3M® VHB® adhesive and features easy-slide window and safety tab.

FEATURES

- Carries up to 4 cards
- Safety tab keeps cards in place
- Holds secure with strong 3M® VHB® adhesive
- Attaches to phone or hardshell case

CODE: CBPW-01-R7



QUIKSTAND® PORTABLE DEVICE STAND

The slim, lightweight QuikStand provides a portable stand for smartphones and small tablets, and is about the size of a credit card, so it fits easily into a wallet or pocket.

FEATURES

- Fits smartphones and tablets up to 7"
- Size of a credit card to fit easily in a wallet
- Front flap adjusts to fit phones of varying thickness with or without cases
- Adjustable support bar allows positioning at multiple angles

CODE: QSD-01-R7





HIPCLIP™ MOBILE DEVICE POCKET CLIP

The HipClip is a stainless steel mountable pocket clip for mobile devices.

FEATURES

- Fits most mobile devices
- Affixes to any hardshell case or accessory
- Secure 3M® VHB® adhesive holds clip firmly in place
- 3M VHB adhesive can be removed without damaging surfaces

CODE: NBC-03-11



HITCH™ PHONE ANCHOR + STRETCH STRAP

Combining protection and convenience, users can anchor and link their phone to small essential items using the adjustable cinch strap, or simply stretch the strap around their wrist to prevent drops and theft.

FEATURES

- Works with cases that feature an enclosed charging port slot
- Compatible with both corded and wireless charging
- Stretchy, grippy silicone strap + adjustable cinch slider
- Includes: Hitch Phone Anchor, S-Biner® MicroLock®, and Stretch Strap

CODE HPSS-09-R7 COLOUR CHARCOAL



HITCH PHONE ANCHOR



STRETCH STRAPS

HITCH™ PHONE ANCHOR + TETHER

Easily tether your phone for security, drop protection, and convenience. The ultra-thin Hitch Phone Anchor fits between your phone and case, allowing you to quickly connect your phone to belt loops and other attachment points using the included coiled tether and S-Biner® MicroLocks.

FEATURES

- Protects from drops and theft
- Works with cases that feature an enclosed charging port slot
- Compatible with both corded and wireless charging
- Coiled tether extends up to 24"
- Includes: Hitch Phone Anchor, coiled tether with two MicroLocks



CODE HPAT-01-R7 COLOUR BLACK/BLACK



HARDWARE

TIE DOWNS & BUNGEEES

GEAR TIES®

CARABINERS

SLIDE LOCK CARABINER BUNGEE

Enhancing the simplicity and security of classic bungees, this bungee integrates a SlideLock locking carabiner at each end for quick, confident attachment.

FEATURES

- Slide-to-lock carabiner for quick + confident connection
- Carabiner remains attached with or without tension
- Strong steel carabiner core
- Premium wear-resistant bungee



CODE	SIZE	COLOUR
BSL24-10-R3	24"	RED
BSL36-03-R3	36"	BLUE
BSL48-17-R3	48"	GREEN

KNOTBONE ADJUSTABLE BUNGEE

This adjustable-size bungee uses two carabiner clips at either end for secure attachment to anchors.

FEATURES

- Carabiner clips for ease-of-use
- #5 size adjusts from 6" - 28"
#9 size adjusts from 10" - 48"
- Self-clipping caps on cord ends to keep them in place



CODE KBB5-01-R3 KNOTBONE #5
CODE KBB9-01-R3 KNOTBONE #9

CAMJAM® TIE DOWN STRAP

These tie down straps are built for functionality, ease-of-use, safety, and ultrasecurity for heavy loads. Using the highest quality materials like high-density weave polypropylene and a proprietary die-cast zinc buckle, the CamJam provides a secure solution for confidently attaching heavy loads.

FEATURES

- Die-cast zinc alloy CamJam mechanism with nickel finish
- Easy tension release
- Working load limit: 700 lb. Break strength: 2100 lb.
- Integrated protective pad beneath buckle



CODE	MODEL
CJWR6-09-R6	CAMJAM TIE DOWN STRAP 6 FT
CJWR12-09-R6	CAMJAM TIE DOWN STRAP 12 FT
CJWR18-09-R6	CAMJAM TIE DOWN STRAP 18 FT

CAMJAM® XT™ ALUMINUM ROPE TIGHTENER

These rope and cord tighteners are a rugged combination of a carabiner and cam mechanism. Paired with a rope or cord, the CamJam XT is the perfect knot-free solution for tensioning, connecting, and securing serious loads.

FEATURES

- Durable cast aluminum
- Rotating cam lock lever allows easy and safe tension adjustments
- XT working load limit: 280 lb. Break strength: 837 lb.
- XT Large working load limit: 500 lb. Break strength: 1500 lb.
- XT fits cord sizes: 1/16" to 3/16"
XT Large fits rope sizes: 1/8" to 3/8"



CODE	MODEL
NCJSA-01-R3	CAMJAM XT CORD
NCJLA-01-R3	CAMJAM XT ROPE

DUAL CAMJAM® TIE DOWN SYSTEM + WEBBING TENSIONER

The Dual CamJam Tie Down System is the ultimate tie down for all of your gear, tools and toys. The Dual CamJam buckle features two separate cam locking mechanisms for precise positioning and security. It's paired with our high-quality polypropylene webbing strap with an integrated end loop for strength and versatility.

FEATURES

- Tie Down System includes high strength, high density 1" polypropylene webbing with end loop
- Tension Boost Technology™ provides twice the tension with half the force
- Cam 1: Position + Lock
- Cam 2: Tighten + Secure
- Works two ways: fixed end configuration + loop configuration
- System working load limit: 530 lb.



- System break strength: 1200 lb.
- Use tensioner with most 1" webbing, no sewing required - also sold separately
- Tensioner working load limit: 600 lb.
- Tensioner break strength: 1800 lb.

CODE	SIZE	COLOUR
CJD12-09-R3	DUAL CAMJAM TIE DOWN SYSTEM 12 FT	■ STEEL/BLACK
CJD-11-R3	DUAL CAMJAM WEBBING TENSIONER	■ BLACK

CAMJAM® CORD TIGHTENER

This sturdy combination of a carabiner and cam mechanism provides a knot-free way to tension, connect, and secure light-to-medium weight loads.

FEATURES

- Sturdy, durable plastic
- Stainless steel carabiner gate
- Fits cord sizes 1/16" - 3/16"



CODE	SIZE
NCJ-01-4R3	CAMJAM 4-PACK
NCJ-25-2R3	CAMJAM 2-PACK WITH 8FT ROPE

FIGURE 9® CARABINER ROPE TIGHTENER

An even easier-to-use version of the Figure 9 that incorporates a carabiner clip which attaches easily to any fixed anchor point.

FEATURES

- Lightweight, strong aluminum
- Integrated carabiner with stainless steel gate
- Laser engraved instructions for ease-of-use
- Small fits cord sizes 1/16" - 3/16"
Large fits rope sizes 1/8" - 3/8"
- Small load limit: 50 lb. Large load limit: 150 lb



CODE	SIZE	COLOUR
C9S-02-01	SMALL	■ BLACK
C9L-02-01	LARGE	■ BLACK

FIGURE 9[®] REFLECTIVE TENT LINE KIT

These Figure 9s plus our ShineLine™ Reflective Cords allow for easier line-tensioning and better visibility.

FEATURES

- Durable glass-filled nylon Figure 9s
- Fits cord sizes 1/16" - 3/16"
- Instructions embedded in each Figure 9 for ease-of-use
- Includes: four Figure 9s and four 8 ft 2.5 mm ShineLine reflective green cords



CODE: F9SP-01-4R3

GEAR PRO[®] UTILITY STRAP

The endlessly versatile GearPro Utility Strap can bundle or secure gear in a pinch, buckling in a swift motion and securing the excess strap in place for a clean connection.

FEATURES

- Strong aluminum buckle
- UV-resistant rubber strap
- Secure strap ends in place with included Strap Cap
- 12 in. and 18 in. working load limit: 70 lbs
- 24 in. working load limit: 80 lbs



CODE	COLOUR
GEARPRO 12"	
USS12-01-R3	■ BLACK
USS12-31-R3	■ ORANGE

CODE	COLOUR
GEARPRO 18"	
USS18-01-R3	■ BLACK
USS18-31-R3	■ ORANGE

CODE	COLOUR
GEARPRO 24"	
USS24-01-R3	■ BLACK
USS24-31-R3	■ ORANGE



GEAR LINE[®] ORGANIZATION SYSTEM

This four foot GearLine features loops, GearTie[®] attachments, and S-Biners to make hanging gear, tools, clothes, and more easier than ever.

FEATURES

- High-quality durable webbing
- 10 polycarbonate S-Biners included
- Gear Tie Reusable Rubber Twist Tie™ on each end for easy secure attachment
- 4 ft length



CODE	COLOUR
GLN4-M1-R8	■ ASSORTED





GEAR TIE® ORIGINAL PROPACKS REUSABLE RUBBER TWIST TIE™

Gear Tie ProPacks feature larger bundles of Gear Tie Reusable Rubber Twist Ties that are ideal for bigger jobs or just because you can never have enough.

FEATURES

- Tough rubber shell is waterproof and UV resistant
- Won't scratch or mark
- Strong wire inside holds its shape
- Reusable – twist it, tie it, reuse it!



CODE	SIZE	COLOUR
GT12-01-2R3	GEAR TIE ORIGINAL REUSABLE RUBBER TWIST TIE 12 IN. - 2 PACK	■ BLACK
GT12-31-2R3	GEAR TIE ORIGINAL REUSABLE RUBBER TWIST TIE 12 IN. - 2 PACK	■ BRIGHT ORANGE
GT18-01-2R3	GEAR TIE ORIGINAL REUSABLE RUBBER TWIST TIE 18 IN. - 2 PACK	■ BLACK
GT18-31-2R3	GEAR TIE ORIGINAL REUSABLE RUBBER TWIST TIE 18 IN. - 2 PACK	■ BRIGHT ORANGE
GT24-01-2R3	GEAR TIE ORIGINAL REUSABLE RUBBER TWIST TIE 24 IN. - 2 PACK	■ BLACK
GT24-31-2R3	GEAR TIE ORIGINAL REUSABLE RUBBER TWIST TIE 24 IN. - 2 PACK	■ BRIGHT ORANGE
GTPP6-01-6R8	GEAR TIE PROPACK 6" - 6 PACK	■ BLACK
GTPP12-01-6R8	GEAR TIE PROPACK 12" - 6 PACK	■ BLACK

COLOUR
■ BLACK
■ BRIGHT ORANGE
■ BLACK
■ BRIGHT ORANGE
■ BLACK
■ BRIGHT ORANGE
■ BLACK
■ BRIGHT ORANGE
■ BLACK
■ BLACK

GEAR TIE® LOOPABLE® REUSABLE RUBBER TWIST TIE™

These Gear Ties feature a sturdy integrated loop on one end allowing them to be easily looped, cinched, and twisted to help hang or bundle items of all shapes and sizes.

FEATURES

- Integrated loop end for convenient hanging and bundling
- Waterproof with tough rubber shell for indoor and outdoor use
- Strong wire inside holds its shape
- Reusable – loop it, twist it, tie it, reuse it!



CODE	SIZE	COLOUR
GLS12-01-2R3	GEAR TIE LOOPABLE 12" 2 PACK	■ BLACK
GLS18-01-2R3	GEAR TIE LOOPABLE 18" 2 PACK	■ BLACK

S-BINER® STAINLESS STEEL DUAL CARABINER

All the usefulness of a traditional single-gated carabiner times two. The stainless steel S-Biner with dual spring gates will hold, secure, and connect just about anything.

FEATURES

- Stainless steel body
- Stainless steel gates
- Individually weight rated
- Not for climbing



CODE	SIZE	COLOUR	CODE	SIZE	COLOUR	CODE	SIZE	COLOUR
SB1-2PK-01	#1 2-PK	■ BLACK	SB3-03-01	#3	■ BLACK	SB5-03-01	#5	■ BLACK
SB1-2PK-11	#1 2-PK	■ STAINLESS	SB3-03-11	#3	■ STAINLESS	SB5-03-11	#5	■ STAINLESS
SB2-03-01	#2	■ BLACK	SB4-03-01	#4	■ BLACK	SB234-03-11	3 PACK	■ BLACK
SB2-03-11	#2	■ STAINLESS	SB4-03-11	#4	■ STAINLESS	SB234-03-01	3 PACK	■ STAINLESS

S-BINER® PLASTIC DUAL CARABINER

This lightweight version of the classic double-gated S-Biner makes it easy to clip, secure, and connect items.

FEATURES

- Made with strong, glass-filled nylon
- Black stainless steel gates
- Not for climbing

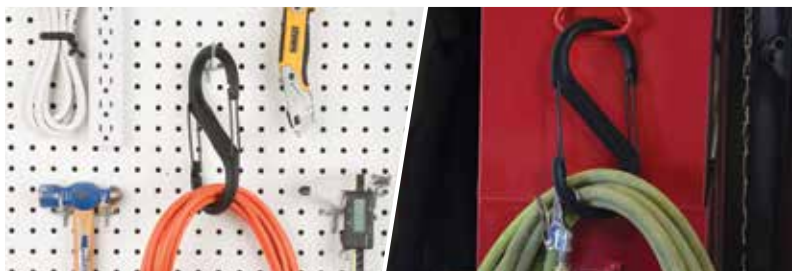

CODE	SIZE	COLOUR
SBP6-03-01BG	#6	■ BLACK
SBP8-03-01BG	#8	■ BLACK
SBP10-03-01BG	#10	■ BLACK

G-SERIES® SLIDELOCK® DUAL CHAMBER CARABINER

This slide-to-lock carabiner allows users to clip keys and gear into the first chamber for easy access, then transfer through the inner gate to the second chamber for secure storage.

FEATURES

- Dual chambers + SlideLock® outer gate
- Stainless steel body
- Stainless steel gates
- Individually weight rated



CODE	SIZE	COLOUR
GSL3-11-R6	#3	■ STAINLESS
GSL4-11-R6	#4	■ STAINLESS

S-BINER® MICROLOCK® STAINLESS STEEL

This stainless steel mini S-Biner features an innovative locking lever which securely locks both gates with a simple twist.

FEATURES

- Stainless steel body
- Stainless steel gates
- Twist to lock

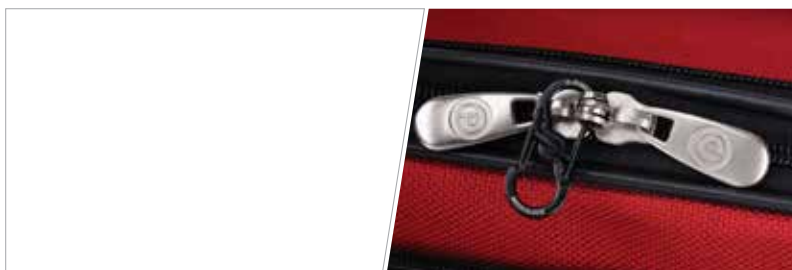

CODE	SIZE	COLOUR
LSBM-01-2R3	2-PACK	■ BLACK
LSBM-07-2R3	2-PACK	■ SPECTRUM

MICROLINK® CARABINER

STAINLESS STEEL

This micro carabiner features a unique gate design that prevents gear loss, allowing users to easily secure keys and other items.

FEATURES

- Narrow gate opening + inner notch prevent gear loss
- Stainless steel body
- Stainless steel gates
- Holds most keys and fobs



CODE KL-11-4R3 **SIZE** 4-PACK **COLOUR** STAINLESS

S-BINER® SLIDELOCK®

STAINLESS STEEL

With double duty S-Biner®, this version has the added bonus of SlideLocks to securely lock each gate independently.

FEATURES

- Stainless steel
- Locking stainless steel gates
- Individually weight rated
- Not for climbing

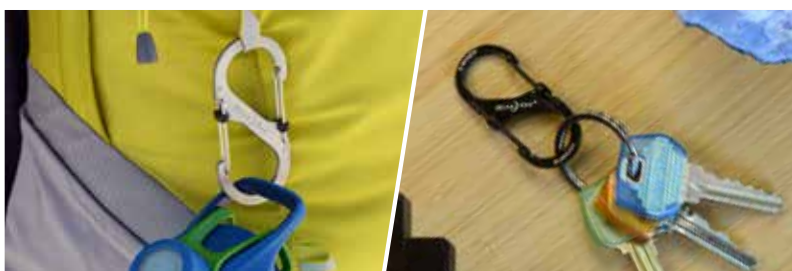

CODE **SIZE** **COLOUR**

LSB2-01-R3	#2	BLACK
LSB2-07-R3	#2	SPECTRUM
LSB3-01-R6	#3	BLACK
LSB3-07-R3	#3	SPECTRUM

CODE **SIZE** **COLOUR**

LSB4-01-R3	#4	BLACK
LSB4-07-R3	#4	SPECTRUM

SLIDELOCK® CARABINER

STAINLESS STEEL

Improving upon traditional carabiners, this Nite Ize® version features a low-profile stainless steel rectangular cross-section body and a slide-to-lock feature on the gate, making it a secure way to carry and connect items.

FEATURES

- Stainless steel carabiner
- Stainless steel gate with slide-to-lock mechanism
- Not for climbing



CODE **SIZE** **COLOUR**

CSL2-01-R6	SLIDELOCK CARABINER STAINLESS STEEL #2	BLACK
CSL3-01-R6	SLIDELOCK CARABINER STAINLESS STEEL #3	BLACK
CSL4-01-R6	SLIDELOCK CARABINER STAINLESS STEEL #4	BLACK

CODE **SIZE** **COLOUR**

		BLACK
		BLACK
		BLACK



EVERYDAY & GIFT

KEY ACCESSORIES & MULTI-TOOLS

FINANCIAL TOOL®

ILLUMINATION

AHHH ...™ STAINLESS BOTTLE OPENER

This double-duty tool has all the functionality of a traditional S-Biner®, plus dual bottle openers.

FEATURES

- Stainless steel body and gates
- Dual bottle openers

CODE

SB0-03-01
SB0-03-11

COLOUR

■ BLACK
■ STAINLESS STEEL



CINCH-A-LOT MINI STRETCH STRAP

Keep earbuds, cords, and essential small items clipped onto your keychain or bag with this grippy, stretchy silicone strap with an adjustable metal cinch slider and included polycarbonate S-Biner® MicroLock®.

FEATURES

- Durable silicone stretch strap
- Cinch slider allows for adjustable fit
- Includes plastic S-Biner MicroLock

CODE

CALS-70-R3
CALS-0211-R3

COLOUR

■ MINT
■ WHITE SPARKLE



IDENTIKEY™ COVERS

These four colorful, universal key identifiers have a write-on tab that folds under to keep the writing protected and keys readily identifiable. The combo pack pairs these identifiers with two MicroLock® S-Biners for quick secure attachment to key rings.

FEATURES

- Color codes and fits most keys
- Writable fold-under tab keeps ink protected and identifies keys
- Waterproof TPR material
- Write on with permanent ink

CODE: KID-A1-4R7

4 PACK  ASSORTED



IDENTIKEY™ TAGS

These durable, colourful write-on tags make key identification simple. The innovative design allows for secure attachment and easy removal.

FEATURES

- 5 colourful TPE tag identifiers
- Waterproof and durable
- Write on with permanent ink
- Compatible with IdentiKey Card Storage System or on their own

CODE: IKCT-A1-5R7  ASSORTED



KEYRING 360™ MAGNETIC QUICK CONNECTOR

Featuring two split rings connected by interlocking neodymium magnets, this solution allows users to keep their keys separate, yet connected.

FEATURES

- Dual stainless steel split rings joined by magnetic connector
- Connector features two powerful neodymium magnets with interlocking plastic housing
- Secure interlocking design keeps key sets connected
- Tabs on each side of connector allow for easy separation

CODE KR360-01-R3  COLOUR BLACK



SLIDELock™ 360° MAGNETIC LOCKING DUAL CARABINER

These locking carabiners are connected by powerful neodymium magnets. They can be used together or independently for quick access to small items like keys or tools. The threaded locking collar adds an extra level of security.

FEATURES

- Dual SlideLock carabiners joined by powerful neodymium magnets
- Cast aluminum carabiners and collar
- Stainless steel locking gates
- Quick release or locking collar

CODE MSBL-08-R7  COLOUR OLIVE



SLIDELock™ KEY RING STAINLESS STEEL

This stainless steel locking carabiner and key ring combination keeps keys separate, yet connected.

FEATURES

- Stainless steel SlideLock carabiner
- High tensile strength nylon webbing
- 3/4" split ring key attachment

CODE CSLW3-01-R6  COLOUR BLACK



SLIDELOCK® KEY RING™ ALUMINUM

This colourful aluminum locking carabiner and key ring combination keeps keys separate, yet connected.

FEATURES

- Solid aluminum SlideLock Carabiner
- High tensile strength nylon webbing
- 3/4" split ring key attachment

CODE

CSLAW3-03-R6

CSLAW3-19-R6

COLOUR

 BLUE

 ORANGE



SLIDELOCK® KEYRACK™ STAINLESS STEEL

This KeyRack features our larger size #4 SlideLock Carabiner and pairs it with five of our favorite stainless steel S-Biner MicroLocks® to hold up to ten keys.

FEATURES

- #4 stainless steel locking-carabiner body
- 5 stainless steel S-Biner MicroLocks with center-locking lever
- Easy to attach and remove keys
- Each stainless steel S-Biner MicroLock holds up to 2 keys

CODE: KCK-11-R3



KEYRACK™ S-BINER®

This stainless steel carabiner clip is paired with six S-Biners to easily hold and identify keys.

FEATURES

- Stainless steel carabiner body
- 6 colourful plastic #0 S-Biners
- Easy to attach, remove, and identify keys

CODE

KRK2-01-R6

COLOUR

  BLACK/ASSORTED



KEYRACK LOCKER® STEEL S-BINER®

This popular item pairs the KeyRack Steel body with six S-Biner MicroLocks for ultimate key security.

FEATURES

- Stainless steel carabiner body
- 6 stainless steel S-Biner MicroLocks with center-locking lever
- Easy to attach and remove keys

CODE: KLK-11-R3





BIGFOOT LOCKER™ KEYRACK™

The "toes" of this key locker securely and quietly hold the five S-Biner MicroLocks in place.

FEATURES

- Stainless steel locking-carabiner body
- 5 stainless steel S-Biner MicroLocks with center-locking lever
- Easy to attach and remove keys
- New Spectrum Finish

CODE **COLOUR**
 KLKBF-11-R6  STEEL
 KLKBF-07-R3  SPECTRUM



KEYRING™ S-BINER®

This continuous stainless steel ring paired with six colourful, polycarbonate S-Biners is the key to security and convenience.

FEATURES

- 1.1" stainless steel ring
- 6 colourful polycarbonate #0 S-Biners
- Easy to attach, remove, and identify keys

CODE: KR62-11-R3

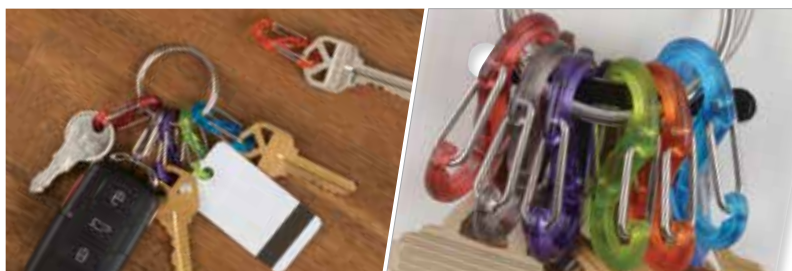

HIDEOUT™ MAGNETIC KEY BOX

Designed for reliability, this magnetic key hider is durable, waterproof, and holds securely using neodymium magnets.

FEATURES

- Two powerful rare earth magnets secure HideOut to any metal surface
- Waterproof and durable design keeps contents safe and dry
- Includes 3M® VHB® adhesive-backed metal plate for attaching HideOut to plastic, wood, and other non-metal surfaces

CODE: KBS-01-R7



HIDEOUT™ XL MAGNETIC KEY BOX

Designed to hold electronic key fobs and bulky keys, this waterproof, plus-sized key hider stays secured under your car, deck, or even the side of your house using powerful neodymium magnets or an adhesive-backed metal plate.

FEATURES

- Extra large box size can hold a key fob and multiple keys at a time
- Three powerful rare earth magnets secure HideOut to any metal surface
- Waterproof and durable design keeps contents safe and dry
- Includes 3M® VHB® adhesive-backed metal plate for attaching HideOut to plastic, wood, and other non-metal surfaces

CODE: KBXL-01-R7



DOOHICKEY® RATCHET KEY TOOL

The DoohicKey Ratchet Tool simplifies quick fixes from home to work, packing in a ratchet with 2 flat bits + 2 Phillips bits for on-the-go fastening or loosening in small spaces

FEATURES

- Includes carabiner clip for easy attachment
- Stainless steel body
- Travel and airport friendly
- Compact + easy-to-use ratchet tool
- Includes: ratchet, flat bit 3.5 + 5.5mm, Phillips bit #1 + #2, bottle opener, standard + metric ruler, wrenches, pry tool, scoring point

CODE **COLOUR**
KMTRT-11-R3  STAINLESS STEEL



DOOHICKEY® KEY TOOL

The DoohicKey Key Tool combines 5 handy tools into one compact design that fits right on your key chain, including a box cutter, bottle opener, wrench, ruler, and flathead screwdriver.

FEATURES

- Includes carabiner clip for easy attachment
- Stainless steel
- Travel and airport friendly
- Includes: box cutter, bottle opener, wrench, ruler, and flathead screwdriver

CODE **COLOUR**
KMT-01-R3  BLACK
KMT-11-R3  STAINLESS STEEL



DOOHICKEY® + KEY TOOL

The DoohicKey+ Key Tool packs endless convenience into one integrated device, featuring a ruler, wrench, bottle opener, serrated edge, scoring point, nail puller, and 2 screwdrivers.

FEATURES

- Grippy edge adds precision and control when opening bottles
- Includes carabiner clip for easy attachment
- Stainless steel
- Travel and airport friendly
- Includes: Phillips screwdriver, flathead screwdriver, ruler, wrench, bottle opener, serrated edge, scoring point, and nail puller

CODE **COLOUR**
KMTSE-11-R3  STAINLESS STEEL



DOOHICKEY® CLIPKEY™ KEY TOOL

The most useful item on a key chain, this mini multi tool is a problem solver trapped in a key's body.

FEATURES

- Stainless steel
- Travel and airport friendly
- Includes: carabiner clip, bottle opener, serrated edge, scoring point, and screwdriver

CODE **KMTCK-01-R3** COLOUR **BLACK**



DOOHICKEY® QUICKEY™ + SKULLKEY™ KEY TOOLS

The Doohickey QuickKey and SkullKey Key Tools bring modern simplicity into a classic key silhouette, featuring a scoring point, bottle opener, file, serrated edge, screwdriver, and 2 unique designs to choose from.

FEATURES

- Die-cast stainless steel
- Travel and airport friendly
- Includes: scoring point, bottle opener, file, serrated edge, and screwdriver

CODE **KMTQK-11-R3** QUICKKEY COLOUR **STEEL**



CODE **KMTSK-11-R3** SKULLKEY COLOUR **STEEL**

DOOHICKEY® FISHKEY™ KEY TOOL

The Doohickey FishKey Tool provides daily convenience and simplicity in one small multi tool, featuring a unique fish-shaped design with a serrated edge for cutting line and opening lure packages, plus a screwdriver, bottle opener, and included S-Biner® for easy attachment.

FEATURES

- Stainless steel
- Travel and airport friendly
- Includes stainless steel S-Biner for quick + secure attachment/detachment
- Includes: serrated edge, flathead screwdriver, and bottle opener



CODE **KMTFKS-11-R6** COLOUR **STEEL**

DOOHICKEY® KEY CHAIN KNIFE

The Doohickey Key Chain Knife puts the everyday-carry functionality of a fold-out locking utility knife in a compact size that's perfect for key chains. The included S-Biner® MicroLock® makes it easy to attach, detach, and secure this knife.

FEATURES

- Features 2" locking stainless steel blade with smooth cutting edge
- Durable + lightweight aluminum body
- Includes MicroLock locking S-Biner for quick + secure attachment/detachment



CODE **KMTK-03-R7** COLOUR **OLIVE**
KMTK-08-R7 COLOUR **BLUE**

FINANCIAL TOOL® MULTI TOOL WALLET

More than just a wallet, this 7-in-1 multi tool is forged from heat-treated stainless steel and equipped with tools to help tackle everyday problems.

FEATURES

- Durable multi tool constructed of 420 heat-treated stainless steel
- Secure high-tensile Cash Wrap strap
- Travel and airport friendly
- Includes: Cash Wrap strap, scraper, bottle opener, wrenches, flathead screwdriver, Phillips screwdriver/tape cutter, standard + metric ruler

CODE
FMT2-11-R7

COLOUR
STAINLESS

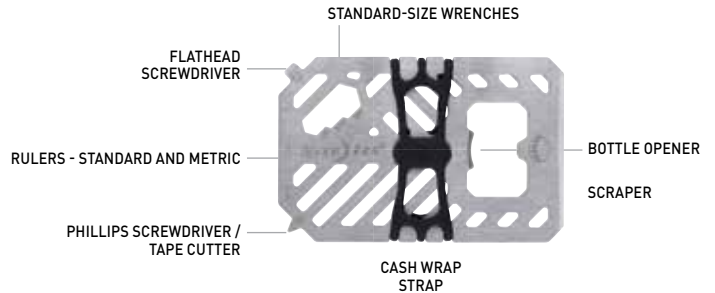
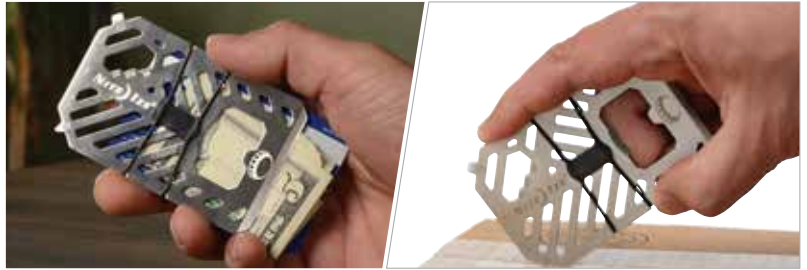

FINANCIAL TOOL® RFID BLOCKING WALLET

This triple-duty Financial Tool is a wallet, multi tool, and RFID blocking protector all in one. Featuring 10 different tools integrated into its compact, heat-treated stainless steel design, it offers endless problem solving solutions all while keeping money and cards safely inside.

FEATURES

- Durable multi tool constructed of 420 heat-treated stainless steel
- High-tensile Cash Wrap strap expands to hold cash and cards securely inside
- Travel and airport friendly
- Includes: Cash Wrap strap, bottle opener, 5 standard-size wrenches, 6 metric-size wrenches, nail puller, Phillips screwdriver, flathead screwdriver, scraper, standard + metric rulers, and protractor

CODE
FMTR-01-R7

COLOUR
BLACK

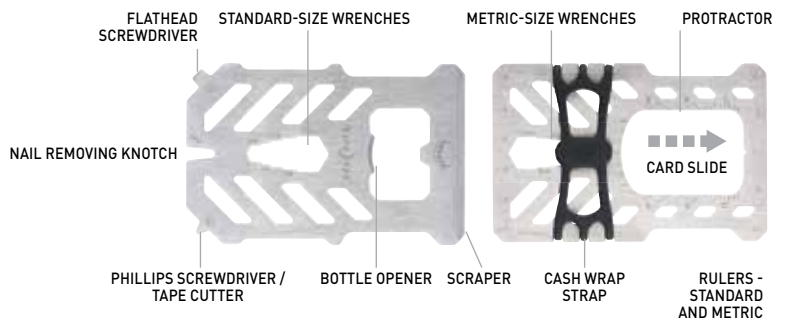

TOOL HOLSTER STRETCH® UNIVERSAL HOLSTER

Made from durable ballistic nylon with elastic side panels, this holster expands to keep tools securely at the hip.

FEATURES

- Secure snap lid closure
- Accessories pocket
- Strong flex-clip design rotates 360° and locks in 8 different positions
- Rotating flex-clip fits waistbands, belts, or straps up to 2.4"



CODE
FAMT-03-01

COLOUR
BLACK

BUGLIT® RECHARGEABLE MICRO FLASHLIGHT

Featuring bendable Gear Tie® legs that make this compact light easy to attach and stand almost anywhere, the rechargeable BugLit puts the fun in functional.

FEATURES

- Four modes: high, low, strobe, momentary
- Recharges in approximately 1.5 hours using micro USB cable (not included)
- Bendable Gear Ties wrap, twist, and stand for hands-free illumination
- Includes S-Biner® for easy attachment



CODE
BGTR02-38-R7

COLOUR
BRIGHT BLUE/CHARCOAL

BUGLIT® MICRO FLASHLIGHT

The powerful microlight is housed in a polycarbonate "body" which connects the BugLit's Gear Tie® "legs," making this an extremely versatile light that can be easily hung, attached, and stored just about anywhere.

FEATURES

- Four modes: high, low, strobe, momentary
- Bendable Gear Ties wrap, twist, and stand for hands-free illumination
- Includes S-Biner® for easy attachment



CODE
BGT02-38-R7

COLOUR
BRIGHT BLUE/CHARCOAL

RADIANT® 100 KEYCHAIN FLASHLIGHT

This powerful, high-quality flashlight is compact enough to fit right on your keychain. The included S-Biner® MicroLock® makes this lightweight keychain accessory easy to attach and detach.

FEATURES

- 100 lumens
- Durable, lightweight aluminum body
- Submersible in 1m of water for up to 30 min
- Modes: high, low
- Includes S-Biner MicroLock for secure attachment



CODE
R100F-19-R7

COLOUR
ORANGE

RADIANT® LED MINI GLOW STICK

An excellent alternative to traditional chemical glowsticks, this LED mini glowstick has replaceable batteries for endless hours of nighttime visibility.

FEATURES

- Twist on/off
- Included S-Biner® for clippability
- Waterproof—it floats!
- Battery run time: 60 hours



CODE
MGS-28-R6
MGS-10-R6

COLOUR
GREEN
RED

RADIANT® RECHARGEABLE LED GLOW STICK

With the ability to choose from color-changing Disc-O mode, three colours, or flashing red, this rechargeable glow stick is versatile and fully waterproof.

FEATURES

- Five modes (plus lockout): Disc-O, green, blue, red, and flashing red
- Submersible in 1m of water for up to 30 min
- Push button on/off + select color
- Recharges in approximately 1.25 hours using micro USB cable (not included)
- Includes S-Biner® for easy attachment



CODE
RGSR-07S-R3

COLOUR
DISC-O

MOONLIT® MICRO LANTERN

A versatile lighting solution without the bulk of a traditional lantern, this clippable swivel-LED provides bright ambient light powered by easily replaceable batteries (included).

FEATURES

- Built-in clip for convenient hanging
- Body swivels 360°
- Push button on/off
- Glow or flash
- Battery run time: 60 hours
- Run time: 8.5 hours



CODE
MLTML-02-R6

COLOUR
WHITE

SPOTLIT® CARABINER LIGHT

This bright little LED is equipped with a carabiner clip, making it extremely versatile and useful to clip anywhere. The long-lasting LED provides an ambient glow bright enough for everything from reading, to finding your keys, to taking a nighttime walk around the neighborhood.

FEATURES

- Secure stainless steel carabiner clip
- Push button on/off
- Battery run time:
Glow: 20 hours | Flash: 25 hours
- Run time: 8.5 hours



CODE
SLG-07-R6

COLOUR
 DISC-0

SPOTLIT® XL RECHARGEABLE CARABINER LIGHT - DISC-0 SELECT™

This SpotLit isn't just bigger, it's micro USB rechargeable too. This large clip-on light shines whenever and wherever you need it most, featuring Disc-0 Select technology with 4 selectable colors and fun, color-changing Disc-0 mode.

FEATURES

- Secure stainless steel carabiner clip
- Four selectable colours + colour-changing
Disc-0 mode
- Push button on/off + select color
- Recharges in approximately 1.5 hours
using micro USB cable (not included)



CODE
SLGR-07S-R6

COLOUR
 DISC-0

TAGLIT™ RECHARGEABLE MAGNETIC LED MARKER

By combining the convenience of rechargeability with an ultra-bright design, the rechargeable TagLit secures magnetically to clothing, hats, and more for nighttime visibility.

FEATURES

- Illuminated polymer strip provides superior visibility
- Passive reflectivity pattern
- Glow or flash
- Recharges in approximately 1.5 hours using
micro USB cable (not included)
- Battery run time: 6 hours



CODE
TGLR-33-R3

COLOUR
 NEON YELLOW/GREEN LED



PET

ACCESSORIES

ILLUMINATION

MICROLINK™ PET TAG CARABINER

This micro carabiner allows owners to clip their dog's tags onto a collar easily and securely, holding strong through every adventure.

FEATURES

- Stainless steel construction
- Unique + secure design prevents loss of tags
- Holds most ID tags
- Clips onto most D-rings on collars + harnesses



CODE: TL-11-2R3 2 PACK STAINLESS

WEARABOUT™ PET CLIPPABLE TRACKER HOLDER

This protective Apple AirTag holder can clip onto a pet's collar or harness and features a slide-to-lock gate to stay securely attached.

FEATURES

- Securely holds AirTag (AirTag not included)
- Lightweight, discreet + protective housing
- Slide-to-lock carabiner
- Easily replace AirTag battery while in holder



CODE: WATP-03T-R6 BLUE

RADDOG® COLLAPSIBLE BOWL

This portable dog bowl is completely leakproof and packs down into a pocket-sized package. Lightweight and reliable, this bowl is perfect for walks, traveling, and more.

FEATURES

- Made from lightweight, coated nylon
- Convenient, foldable design
- Weighs less than 1 ounce
- Easily attaches and detaches using included S-Biner® MicroLock®
- Holds up to 16 ounces of water or food



CODE: RWB-03-R8 BLUE

SPOTLIT® COLLAR LIGHT

This bright little LED easily clips onto any collar to provide instant illumination for your four-legged friend, ensuring they always stay seen whether on a walk, at the campsite, or in the backyard.

FEATURES

- Secure stainless steel carabiner clip
- Push button on/off
- Battery run time:
Glow: 20 hours | Flash: 25 hours



CODE: PSLG-02-R6 WHITE
 CODE: PSLG-07-R6 DISC-0
 CODE: PSLG-10-R6 RED

SPOTLIT® RECHARGEABLE COLLAR LIGHT - DISC-O TECH™

See Spot run! This rechargeable SpotLit clips onto any collar for brilliant illumination all night long, featuring a Disc-O Tech module with colour-changing Disc-O mode and 4 selectable colours in glow or flash.

FEATURES

- Secure stainless steel carabiner clip
- Disc-O Tech module features four colors (glow/flash), colour-changing Disc-O mode, and memory feature
- Memory feature automatically saves last color setting when you turn back on
- Push button on/off
- Recharges in approximately 2 hours using micro USB cable (not included)
- Run time: 5 hours



CODE: PSLGSR-07S-R6  DISC-O

PETLIT® COLLAR LIGHT

Great for smaller dogs, these clippable LED collar lights keep pets visible in the dark.

FEATURES

- Secure carabiner clip
- Bright white LED
- Twist on/off
- Battery run time: 24 hours



CODE: CL02-03-02JE  CRYSTAL JEWEL
CODE: PCL02-03-17PA  LIME PAW

NITEDOG® RECHARGEABLE LED COLLAR

This light-up dog collar is rechargeable, easy to adjust, and so bright that you have to see it to believe it. Features a convenient belt-buckle style closure and end-to-end illumination that is highly visible and water-resistant.

FEATURES

- 360° visibility
- Integrated optical fiber and two high-powered LEDs provide full-length illumination
- Glow or flash
- Recharges in approximately 1.25 hours using micro USB cable (not included)
- Run time Blue/Blue: 6.5 hours



CODE: NDCRS-03-R3 - SMALL  BLUE/BLUE LED
CODE: NDCRM-03-R3 - MEDIUM  BLUE/BLUE LED
CODE: NDCRL-03-R3 - LARGE  BLUE/BLUE LED

NITEHOWL® LED SAFETY NECKLACE

The NiteHowl ensures no dog gets lost in the dark, providing 360° illumination and cut-to size customization to maintain visibility from the park to the street and beyond.

FEATURES

- Cut to fit from 12" - 27" (30cm - 69cm)
- Glow or flash
- Battery run time: 60 hours



CODE: NHO-10-R3 █ RED

NITEHOWL® RECHARGEABLE LED SAFETY NECKLACE - DISC-0 SELECT™

The rechargeable NiteHowl helps owners keep a careful eye on their mid-sized and large pups whether in the yard or at the park, featuring a cut-to-size fit and Disc-0 Select technology with three selectable colours and colour-changing Disc-0 mode.

FEATURES

- Cut to fit from 12" - 27" (30cm - 69cm)
- Three selectable colors + color-changing Disc-0 mode with unique color-blending pattern
- Recharges in approximately 1.5 hours using micro USB cable (not included)
- Run time: 5.5 hours



CODE: NHOR-07S-R3 █ █ █ DISC-0

NITEDOG® RECHARGEABLE LED LEASH

Be visible from dusk 'til dawn with this rechargeable and highly visible light-up leash. This water-resistant 5' leash features end-to-end illumination, a comfortable cushioned handle, and easy push-button operation.

FEATURES

- Integrated optical fiber and two high-powered LEDs provide full-length illumination
- 5' length (4' illuminated area)
- Glow or flash
- Recharges in approximately 1.25 hours using micro USB cable (not included)
- Run time Blue/Blue: 6.5 hours



CODE: NDLR-03-R3 █ BLUE/BLUE LED

GLOW STREAK® LED BALL

Dogs don't get tired just because the sun goes down. This LED ball lights up the night for endless hours of play.

FEATURES

- Motion activated and auto shut-off
- Waterproof - it floats!
- Replaceable batteries included
- Battery run time: 35 hours





CODE: GSB-07-R7 █ █ █ DISC-0

Contact Details

Burton McCall Limited
163 Parker Drive, Leicester, LE4 0JP

Tel Main Switchboard: 0116 234 4600
www.burton-mccall.co.uk

 @BTNMCCALL
 @burtonmccalltd
 @burtonmccalltd

Sales Office

Tel: 0116 234 4611/4622
Email: sales@burton-mccall.com

Customer Services

Tel: 0116 234 4646
Email: customer.services@burton-mccall.com

