



CLIMATE  
NEUTRAL  
CERTIFIED

# BioLite

 COOK

 CHARGE

 LIGHT



**BioLite Directory**

We are on a mission

# TO EMPOWER PEOPLE & PROTECT OUR PLANET

through access to renewable energy

An extra hour of study at night; a charged phone that can send a mobile payment; a family meal cooked without inhaling smoke. These are just a few of the ways energy access can transform an off-grid household – and all of them are core to BioLite's mission.

When you purchase a BioLite product, you support our work delivering renewable energy solutions to households living beyond the grid. This means cooking fires without smoke, solar panels that keep families charged, and lighting that extends the day when the sun goes down.

Thank you for helping us build a future where energy can be shared by all.

## IMPACT BY THE NUMBERS



**3,612,951**  
people impacted



**4,812,600**  
kilowatt hours of electricity generated



**718,964**  
tons of CO2 offset





## 🔥 COOK

6

### PORTABLE STOVES

CampStove 2+	8
CampStove Complete Cook Kit	8
CampStove KettlePot & Coffee Set	9 <b>NEW</b>
CampStove Portable Grill	9
BioFuel Pellets	9

### CAMPFIRE EVOLVED

FirePit+	11
FirePit Grill Lid	11
FirePit Griddle	12
Prep & Grill Toolkit	12
FirePit Carry Bag	13
FirePit Poker	13
FirePit Mat	13

## ⚡ CHARGE

14

### POWER STATIONS

BaseCharge 600	15	<b>NEW</b>
BaseCharge 1500	16	<b>NEW</b>
Charging Tables	17	
Cables & Accessories	18	<b>NEW</b>

### SOLAR PANELS

SolarPanel 100	20	<b>NEW</b>
SolarPanel 5+	21	
SolarPanel 10+	21	

### USB POWERBANKS

Charge 20 PD	23
Charge 40 PD	23
Charge 80 PD	23

## 💡 LIGHT

24

### HEADLAMPS

HeadLamp 325	26	<b>NEW</b>
HeadLamp 425	27	<b>NEW</b>
HeadLamp 800 Pro	28	<b>NEW</b>

### USB LANTERNS

AlpenGlow 250	30
AlpenGlow 500	30

### SOLAR LIGHTING

SolarHome 625	31	<b>NEW</b>
---------------	----	------------

### OVERHEAD STRING LIGHTS

SiteLight String	31
------------------	----

A woman with a red headwrap and a red and orange patterned top is looking up at a solar light hanging from the ceiling in a rustic room. The room has a textured wall with some graffiti and a large black barrel labeled 'POLY' in the background. The solar light is a small, rectangular device with a blue and white casing, emitting a bright light. The overall scene is dimly lit, with the solar light being the primary source of illumination.

Using a unique business model called **Parallel Innovation**, our team develops core energy technologies that are applicable to two distinct customer segments:

**Off-grid households**  
in emerging markets in  
Africa and Asia.



**Outdoor recreation customers**  
seeking renewable and rechargeable  
ways to cook, charge, and light.





# COOK

## PORTABLE STOVES

CampStove 2+



NEW

CampStove KettlePot & Coffee Set

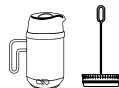

CampStove Portable Grill



CampStove Complete Cook Kit



BioFuel Pellets



## CAMPFIRE EVOLVED

FirePit+



FirePit Grill Lid



FirePit Carry Bag



FirePit Poker



FirePit Griddle

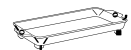

Prep & Grill Toolkit

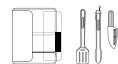

FirePit Mat



## INSIDE THE TECH: CampStove 2+

BioLite's origin story centers around a technology that turns fire into electricity - and creates a much cleaner burn in the process.



BioLite's patented design converts **heat** from your fire into usable **electricity**, powering an internal **airflow** system that optimizes combustion, burning smoke before it has a chance to escape.

Surplus electricity is stored in the onboard battery, enabling you to access power via USB when you need it.

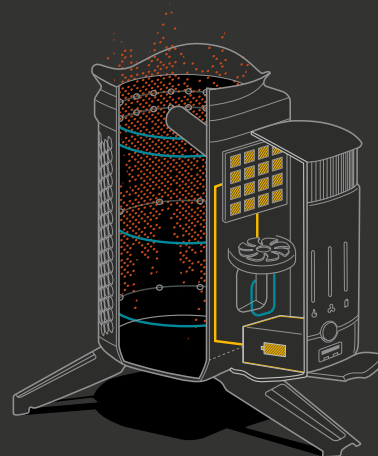





## CampStove 2+

CSC0200

### Turn Fire Into Electricity

Turn fire into electricity with BioLite's award-winning wood stove. Patented thermoelectric combustion technology creates a vortex of smokeless flames for a portable campfire that can cook your meals and charge your gear. Featuring an updated 100 lumen FlexLight with ChromaReal LED technology, cook with confidence at night thanks to accurate color rendering.



-  **3200 mAh Integrated Battery**
-  **100 Lm ChromaReal FlexLight Included**
-  **Extra Storage Stuffsack**
-  **Smart LED Dashboard**
-  **Smokeless Flames**

#### TECH SPECS

##### BATTERY

3,200 mAh

##### WEIGHT

935 g

##### BOIL TIME

4.5 minutes for 1 L

##### FLEXLIGHT (INCLUDED)

100 lumens

##### FUEL

Renewable biomass (twigs, sticks, pellets)

##### USB OUTPUT

1x USB A, 5V / 2.0A

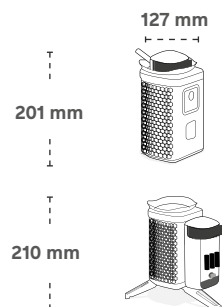





## CampStove Complete Cook Kit

BNA0100

### Portable Wood Cooking System

Cook, boil, grill, and charge with this outdoor camp kitchen. Generate electricity and create smokeless wood flames with the award-winning CampStove 2+ while cooking up meals and beverages with the Portable Grill, KettlePot, and Coffee Press accessories. Featuring an updated 100 lumen FlexLight with ChromaReal LED technology, cook with confidence at night thanks to accurate color rendering.



-  **On-Demand Electricity**
-  **Runs On Sticks Or Pellets**
-  **Create Full Meals & Hot Beverages**
-  **100 Lm ChromaReal FlexLight Included**

#### TECH SPECS

##### TOTAL WEIGHT

2.25 kg

##### INCLUDED IN BUNDLE

CampStove 2+  
CampStove Portable Grill  
CampStove KettlePot

KettlePot Coffee Press  
FlexLight 100



## CampStove KettlePot & Coffee Set

BNA0101

NEW

### 1.5L Pot For CampStove & Coffee Accessory For KettlePot



#### TECH SPECS

##### MATERIALS

Stainless steel, silicone, plastic

##### WEIGHT

465 g

##### MATERIALS

BPA-free polypropylene

##### VOLUME

Boils 1-6 cups



Featherlite and Food safe



Make 6 Cups of Coffee

## CampStove Portable Grill

CSD0200

### Tabletop Grill For CampStove



#### TECH SPECS

##### MATERIALS

Stainless steel

##### WEIGHT

850 g



Portable and Light

## BioFuel Pellets

CSG0301

### For CampStove - 1KG

Wood fires have never been easier. Enjoy gourmet flavours and long burn times with BioLite's premium BioFuel Pellets. Ideal for outdoor cooking, rainy conditions, or backup fuel when sticks are scarce. Quick to light and foodsafe.



Portable and Light

#### TECH SPECS

##### BURN TIME

2 hours

##### DIMENSIONS

21.59 x 11.43  
x 6.35 cm

##### WEIGHT

1kg



1 Bag = 2 Gas Cannisters

## INSIDE THE TECH: FirePit+

The Secret to a Better Fire?  
Burn The Smoke. Smoke is just  
unburned fuel that has escaped  
your fire - we don't let that happen.

### CLEAN COMBUSTION TECHNOLOGY

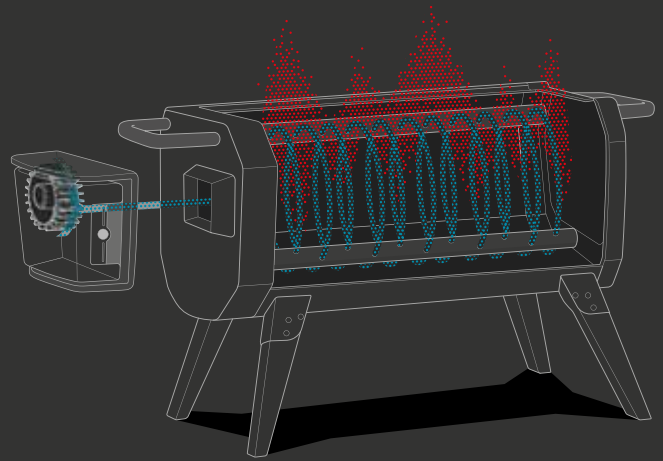

BioLite technology creates a carefully calibrated **airflow** using an internal fan to inject oxygen into the fire. With 51 air jets distributed across the FirePit's burn chamber, the result is a highly efficient and complete burn.



### See Fire, Not Smoke

With capacity for up to four standard firewood logs, the BioLite FirePit creates a hyper-efficient burn with patented airflow technology and gives you a front-row seat to the magic thanks to the X-Ray Mesh Body, enabling 360 views. Lift the fuel rack and toss in charcoal to transform the FirePit into a hibachi-style grill, complete with an included grill grate.



-  12,800 mAh Battery For Longer Run Times
-  High-Temp Enamel Coating
-  X-Ray Mesh For 360° Viewing
-  Use Wood or Charcoal
-  Bluetooth Enabled

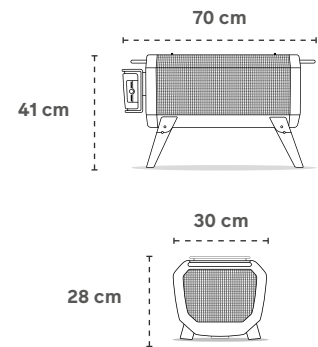

**TECH SPECS**

**BURN TIME**

Fan Low: 30 Hours  
 Fan Medium: 14 Hours  
 Fan High: 7 Hours

**WEIGHT**

8.98 kg

**COOKING SURFACE**

822 cm<sup>2</sup>

**FUEL**

Firewood or charcoal

**INPUTS/OUTPUTS**

Micro USB/USB A

FirePit Grill Lid

FPF0100

### Concentrated Cooking

Turn your FirePit Grill into a wood-fired oven and take your outdoor cooking to the next level. Featuring enamel coated stainless steel construction, this durable accessory integrates with the FirePit to concentrate heat for both low-and-slow and quick-grill cooking methods.



-  Heat-Resistant Handles
-  Adjustable Air Vent For Heat Control

**TECH SPECS**

**TOTAL WEIGHT**

1.77 kg

**MATERIALS**

Enamel-coated steel

**DIMENSIONS**

56 x 32 x 16 cm

**FirePit Griddle**

FPE0100

**Flat Surface Cooktop for FirePit**

Designed to perfectly fit the FirePit, this cast iron griddle will transform the way you do breakfast outside. A pre-seasoned nonstick surface means great meals from the very first sizzle while the raised edges help contain grease and other runoff. May be used on its own or pair with the FirePit OvenTop (sold separately) for even more concentrated cooking.



Durable Cast Iron



Pre-seasoned, Nonstick Surface



**TECH SPECS**

**TOTAL WEIGHT**

3.98 kg

**MATERIALS**

Nonstick cast iron

**DIMENSIONS**

49 x 24 x 50 cm

**FirePit Carry Bag**

FPD0100

**Durable Canvas Haul Bag**



Fits FirePit + All Accessories Inside



Doubles as Firewood Carrier

**TECH SPECS**

**MATERIALS**

Heavy duty canvas

**DIMENSIONS**

61 x 41 x 32 cm

**Prep & Grill Toolkit**

BNB0101

**Go-To Utensils, All Rolled Up**



Durable, Food Grade Materials



Kit Rolls Up For Compact Storage

**TECH SPECS**

**INCLUDES**

Santoku knife  
Slotted turner  
Locking tongs  
Tool roll

**MATERIALS**

Heat resistant stainless steel,  
nylon

**FirePit Poker**

FAB0200

**Fuel & Fire Management**



Adjust Fuel Rack For Wood  
& Charcoal



Tend Your Fire

**TECH SPECS**

**MATERIALS**

Stainless steel,  
silicone rubber

**DIMENSIONS**

59 x 5.6 x 1.4 cm

**WEIGHT**

147 g

**FirePit Mat**

FAA0200

**Ground Protector For FirePit**



Protects Sensitive Surfaces  
Like Decks & Grass

**TECH SPECS**

**MATERIALS**

Aluminum  
coated  
fiberglass  
fabric

**DIMENSIONS**

80.8 x 61.0 cm

**WEIGHT**

450 g



# ⚡ CHARGE

## POWER STATIONS

NEW

BaseCharge 600



NEW

BaseCharge 1500



## USB POWERBANKS

Charge 20 PD



Charge 40 PD



Charge 80 PD



## SOLAR PANELS

NEW

SolarPanel 100

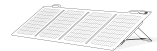

SolarPanel 5+





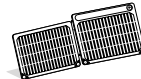

SolarPanel 10+



## Build Your Own Grid

A high capacity power station ready to keep you charged off-grid, the BaseCharge 600 delivers 622 watt hours of flexible energy to your own personalized ecosystem of devices for an on-grid experience wherever you may be. Integrates with BioLite Solar for full solar generator solution and utilizes **Maximum Power Point Tracking** to pull up to 30% more energy than other non-MPPT systems.

-  **25% More Capacity Than 500 Wh Power Stations**
-  **Up to 600 W (1,000 W Surge) AC Output**
-  **USB-C PD (100 W) and Wireless Charging Included**
-  **Extra Large Easy-Read Display for Real-time Feedback & Control**
-  **Safe & Reliable Design With 12 Checkpoint Battery Safety System**



### TECH SPECS

#### BATTERY

622 Wh (21.6 V, 28.8 Ah)  
Li-Ion (NMC)

#### INPUTS

**Wall/Solar Input (HPP):**  
120 W (10-30 V DC, 10 A max)  
**USB-C PD:** 100 W

#### AC OUTPUTS

**US: (2x) 110 V:** Pure Sine Wave, 600 W, 1,000 W Surge  
**EU/UK/AUS: (2x) 230 V:** Pure Sine Wave, 600 W, 1,000 W Surge

#### WIRELESS OUTPUT

10W Wireless Charger

#### DC OUTPUTS

**(1x) 12 V Car Port Output:** 120 W  
**(2x) 12 V DC Barrel Ports:** 120 W,  
5.5 mm OD / 2.1 mm ID

#### USB OUTPUTS

**(2x) USB-A:** 5 V/2.4 A  
**(1x) USB-C:** 5 V/3.0 A  
**(1x) USB-C PD:** 5 V, 9 V, 12 V,  
20 V / 5 A (100 W)

#### DIMENSIONS

309 x 200 x 201 mm

#### WEIGHT

5.9 kg

#### CHARGE TIME

7 Hours (Included Wall Charger)  
3.5 Hours (Wall Charger + USB-C PD)  
6 Hours (Peak Input, 1x SolarPanel 100)

## Scale Up Your Off-Grid Power

Looking to power bigger jobs or longer periods of time? Step up to the BaseCharge 1500 and have 1521 watt hours of shareable energy at your fingertips: from medical devices to refrigerators, this high capacity power station can handle hungry devices and an array of electrical requirements. Integrates with BioLite Solar for full solar generator solution and utilizes **Maximum Power Point Tracking** to pull up to 30% more energy than other non-MPPT systems.



**USB-C PD (100 W) and Wireless Charging Included**



**Up to 1200 W (2,400 W Surge) AC output**



**Extra Large Easy-Read Display for Real-time Feedback & Control**



**Safe & Reliable Design With 12 Checkpoint Battery Safety System**



### TECH SPECS

#### BATTERY

1521 Wh (21.6 V, 70.4 Ah)  
Li-Ion (NMC)

#### INPUTS

**Wall/Solar Input (HPP):**  
400 W (10-30 V DC, 20 A max)  
**USB-C PD:** 100 W

#### AC OUTPUTS

**US: (3x) 110 V:** Pure Sine Wave, 1200 W, 2,400 W Surge  
**UK/EU/AUS: (3x) 230 V:** Pure Sine Wave, 1200 W, 2,400 W Surge

#### WIRELESS OUTPUT

10W Wireless Charger

#### DC OUTPUTS

**(1x) 12 V Car Port Output:** 120 W  
**(2x) 12 V DC Barrel Ports:** 120 W, 5.5 mm OD / 2.1 mm ID

#### USB OUTPUTS

**(2x) USB-A:** 5 V/2.4 A  
**(2x) USB-C:** 5 V/3.0 A  
**(1x) USB-C PD:** 5 V, 9 V, 12 V, 20 V / 5 A (100 W)

#### DIMENSIONS

367 x 310 x 209 mm

#### WEIGHT

12.1 kg

#### CHARGE TIME

13.5 Hours (Included Wall Charger)  
8 Hours (Wall Charger + USB-C PD)  
4 Hours (Peak Input, 4x SolarPanel 100)



# CHARGING TABLES

## BaseCharge 600



SCENARIO /DEVICES	PORT	RATING	METRIC
<b>CAMPING</b>			
Smartphones	USB	48	Charges
BioLite AlpenGlow 500	USB	23	Charges
Dometic 45L Cooler	USB	15	Hours
<b>OFF-GRID OFFICE</b>			
Laptop Computer	PD	9	Charges
DSLR Camera Battery	AC	34	Charges
POV Camera	USB	106	Charges
<b>REMOTE WORKSITE</b>			
Cordless Tool Charges	AC	9	Charges
10,000 Lumen Worklights	AC	6	Hours
<b>HOME BACKUP</b>			
CPAP	AC	13	Hours
55" TV	AC	6	Hours

## BaseCharge 1500



SCENARIO /DEVICES	PORT	RATING	METRIC
<b>CAMPING</b>			
Smartphones	USB	117	Charges
Blended Margaritas	AC	164	Margs
Dometic 45L Cooler	DC	137	Hours
<b>OFF-GRID OFFICE</b>			
Laptop Computer	PD	22	Charges
DSLR Camera Battery	AC	82	Charges
Quadcopter Drone	USB	20	Charges
<b>REMOTE WORKSITE</b>			
Corded Drill	AC	57	Minutes
10,000 Lumen Worklights	AC	51	Minutes
<b>HOME BACKUP</b>			
Refrigerator	AC	20	Hours
Microwave	AC	62	Minutes
CPAP	AC	31	Hours
55" TV	AC	16	Hours

**4x1 Solar Chaining Adapter**

ACA0103

NEW

Adapter cable to allow up to 4 BioLite SolarPanel Products to connect to a single BaseCharge powerstation



## TECH SPECS

LENGTH	CONNECTOR TYPE	GAUGE
360 mm	1x High Power Pole (HPP) , Output 4x High Power Pole (HPP), Inputs	(4) 16AWG/14AWG

**Solar Power Extension Cable, 15 ft**

ACA0104

NEW

4.5m long extension cable for use with BioLite SolarPanel 100 and BaseCharge series powerstations. Anderson Power Pole (APP) connections on both ends.



## TECH SPECS

LENGTH	CONNECTOR TYPE	GAUGE
4.5 m	1x High Power Pole (HPP), Output 1x High Power Pole (HPP), Input	12 AWG

**Solar MC4 to HPP Adapter**

ACA0101

NEW

Adapter cable to allow use of MC4 solar panel connectors with BioLite BaseCharge



## TECH SPECS

LENGTH	CONNECTOR TYPE	GAUGE
380 mm	1x High Power Pole (HPP) , Output 2x MC4 Connectors (+, -), Inputs	16AWG/12AWG

**12 V Car Charger Cable**

ACA0102

NEW

Adapter cable to allow charging BioLite BaseCharge powerstations from 12 V carport (cigarette lighter)



## TECH SPECS

LENGTH	CONNECTOR TYPE	GAUGE
3 m	1x High Power Pole (HPP) , Output 1x 12 V Male Carport, Input	18 AWG (15 A fuse)

## INSIDE THE TECH: SolarPanels

### The Most From The Sun In Minimalist Form

#### OPTIMAL SUN SYSTEM

BioLite's SolarPanel Series pairs user-centric design with minimalist materials to create a more powerful charge. Instead of cumbersome casings and plastics, our proprietary panel-bonding design allows us to feature a sun-optimizing kickstand and sundial while maintaining an ultraslim, packable profile.

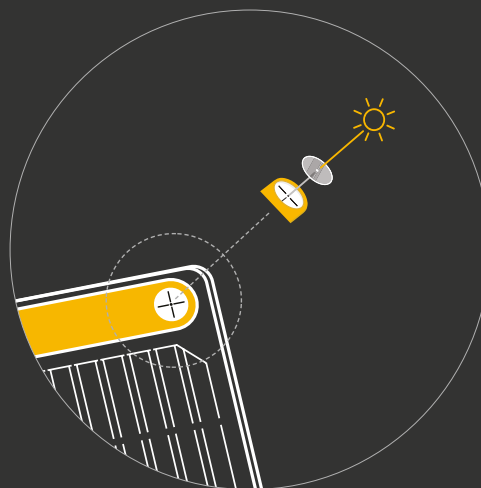

## SolarPanel 100

SPD0100

NEW

## Highly Powerful, Highly Packable

The BioLite SolarPanel 100W is a 100 watt, lightweight, chainable solar panel that offers serious power and ultimate packability for your off-grid activity. The sleek ETFE laminated construction enables the high efficiency monocrystalline cells to run at peak performance without any unnecessary bulk or materials while simultaneously providing protection from surprise showers. Power devices directly through the integrated USB-A and USB-C PD ports or pair with the BioLite Power Station for a full solar generator solution.



Optimal Sun System Sets Panel Up for Direct Rays via Integrated Sundial and Kickstand



Packs Down to 51x36x4 cm With Easy-Carry Handles



Durable and Water Resistant, With Storage Pouch for Added Protection



Works with BioLite or non-BioLite Stations using a standard connector



Compatible With 4x1 Chaining Adapter Cable for up to 400W Solar Generator

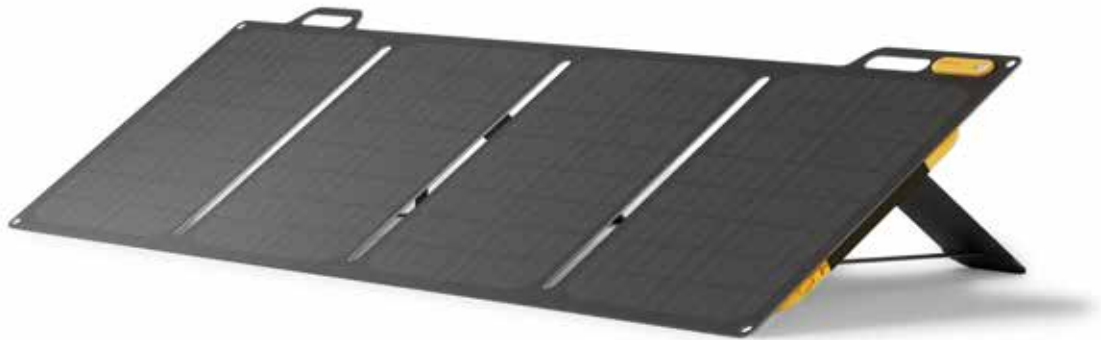

## TECH SPECS

## WEIGHT

4.3 kg

## OUTPUTS

High Power Pole (HPP)  
Powerstation connection  
USB-C PD, 45 W  
2x USB-A

## POWER OUTPUT

100 W in Peak  
Sunshine

## DIMENSIONS (FOLDED)

50.8 x 36.3 x 3.8 cm

## DIMENSIONS (UNFOLDED)

50.8 x 146.0 x 2.5 cm

## 5 Watt Panel with Power Storage

Featuring BioLite's Optimal Sun System, an integrated sundial aligns you to the sun to capture direct rays and a 360 degree kickstand simplifies positioning on uneven terrain. Designed to put you in control of your energy, Maximum Power Point Tracking helps you get the strongest charge under all conditions while the 3,200 mAh on-board battery stores power, enabling you to charge devices when you need it most.



Real Time Power



On-Board 3,200 mAh Battery



Sundial For Optimal Alignment



Ultraslim Design

### TECH SPECS

#### WEIGHT

390 g

#### INPUTS/OUTPUTS

Micro USB charge in  
USB charge out

#### DIMENSIONS

257 x 208 x 24 mm

#### BATTERY

3,200 mAh

#### POWER OUTPUT

5 watts

#### WEATHER RESISTANCE

IPX4

## SolarPanel 10+

SPC0200

## 10 Watt Panel with Power Storage

Looking for more power? Double-down with the folding SolarPanel 10+ and enjoy the same optimizing benefits of the 5+, but with twice the output. Thanks to minimalist construction, the folding design maintains a small footprint, slipping easily into laptop sleeves for ultimately portability.



Real Time Power



On-Board 3,200 mAh Battery



Sundial For Optimal Alignment



Ultraslim Fold-Flat Design

### TECH SPECS

#### WEIGHT

558 g

#### INPUTS/OUTPUTS

Micro USB charge in  
USB charge out

#### DIMENSIONS (FOLDED)

257 x 208 x 24 mm

#### BATTERY

3,200 mAh

#### POWER OUTPUT

10 watts

#### WEATHER RESISTANCE

IPX4

## CHARGE SERIES

### High Power USB-C Charging

Designed to power the next generation of personal electronics, BioLite's Charge Series features USB-C Power Delivery for faster, more flexible charging. With a range of options to service smartphones, tablets, and compatible laptops, our durable powerbanks are FAA Carry-on compliant and utilize an ultra-packable form factor, making this series the perfect travel companion.



USB-C PD for Faster Charging



Durable Case Construction



FAA Carry-On Compliant



**Charge 20 PD**

CBA0100

**6000mAh USB-C PD Power Bank****TECH SPECS****BATTERY**

6,000 mAh, (22.2 Wh)

**CHARGE TIME**

2 hrs by up to 18W USB C-PD

**USB A & USB C-PD  
POWER OUTPUT**

5V/3.0A, 9V/2A, 12V/1.5A

**WEIGHT**

165 g

**INPUTS**

USB C-PD, up to 18W

**DIMENSIONS**

112.3 x 51.0 x 24.8 mm

**Charge 40 PD**

CBB0100

**10,000mAh USB-C PD Power Bank****TECH SPECS****BATTERY**

10,000 mAh, (37 Wh)

**CHARGE TIME**

2.5 hrs by up to 18W USB C-PD

**USB A & USB C-PD  
POWER OUTPUT**

5V/3.0A, 9V/2A, 12V/1.5A

**WEIGHT**

265 g

**INPUTS**

USB C-PD, up to 18W

**DIMENSIONS**

139.5 x 78.3 x 24.0 mm

**Charge 80 PD**

CBC0100

**20,000mAh USB-C PD Power Bank****TECH SPECS****BATTERY**

20,000 mAh, (74 Wh)

**CHARGE TIME**

5 hrs by up to 18W USB C-PD

**USB A & USB C-PD  
POWER OUTPUT**

5V/3.0A, 9V/2A, 12V/1.5A

**WEIGHT**

465 g

**INPUTS**

USB C-PD, up to 18W

**DIMENSIONS**

221.5 x 78.3 x 24.0 mm



# LIGHT

## HEADLAMPS

NEW

HeadLamp 325



NEW

HeadLamp 425



NEW

HeadLamp 800 PRO

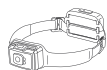

## USB LANTERNS

AlpenGlow 250



AlpenGlow 500



## SOLAR LIGHTING

NEW

SolarHome 625



## OVERHEAD STRING LIGHTS

SiteLight String





## INSIDE THE TECH: HeadLamp Series

Our line of HeadLamps are not only designed for peak performance, the proprietary construction delivers the best fit of any headlamp on the market.

### 3D SLIMFIT CONSTRUCTION

By integrating our electronics into the fabric with a custom molded housing, we pack all your lighting into an ultra-thin facing that is designed to fit as seamlessly as a contact lens.

Our headlamps move with you as a single unit and you soon forget it's even there.

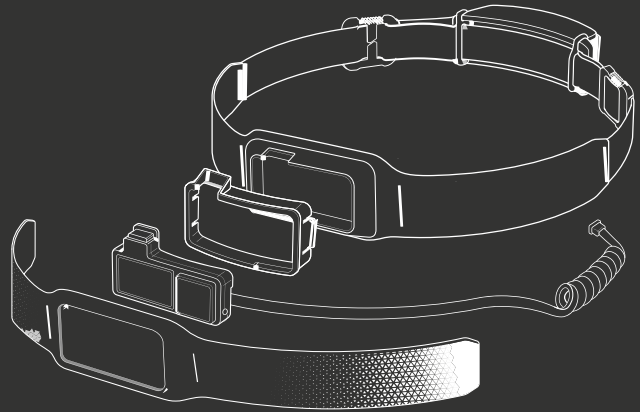

HeadLamp 325

NEW

The End of Disposable Batteries Starts Here

A minimalist design that maximizes comfort and fit, HeadLamp 325 is a compelling entry into the rechargeable landscape. Delivering 325 lumens, four lighting modes, and weighing only 50 grams, this generalist headlamp is ready to go head-to-head with alkalines – and win.

-  3D SlimFit Construction
-  USB Rechargeable
-  4 Modes, Including Dimmable Red
-  Weighs Only 50g



● HPB0310  
MIDNIGHT GREY



● HPB0311  
OCEAN TEAL



● HPB0312  
EMBER YELLOW

TECH SPECS

**LUMENS**  
325 Lm



**BATTERY**  
700 mAh,  
USB Rechargeable

**BEAM DISTANCE**  70M  
Spot

**BURN TIME (HOURS)**  
40 LO/3 HI

**WEIGHT**  
50 g

**MODES**

-  Red Flood + Dimming
-  Red Strobe
-  White Strobe
-  White Spot + Dimming

**WATER RESISTANCE**  
IPX4

### No-Bounce, Ultra-Thin, Rechargeable Head Light

HeadLamp 425 combines an ultra-thin 9mm front with balanced weight and moisture-wicking fabrics to create a fit so comfortable, you'll forget you are wearing it. With five front modes and a rear red light for added visibility, this headlamp is ready to illuminate your next adventure

-  3D SlimFit Construction
-  USB Rechargeable
-  9mm Ultra-Thin Front
-  Weighs Only 69g
-  Rear Red Flood & Strobe



 HPA0310  
MIDNIGHT GREY



 HPA0311  
OCEAN TEAL



 HPA0312  
EMBER YELLOW

#### TECH SPECS

**LUMENS**  
425 Lm

**BATTERY**  
1000 mAh,  
USB Rechargeable

**BEAM DISTANCE**

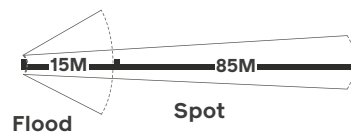

**BURN TIME (HOURS)**  
60 LO/3.5 HI

**WEIGHT**  
78 g

**MODES**

-  Red Flood
-  White Flood + Dimming
-  White Strobe
-  White Spot + Dimming
-  Red Rear Strobe





**WATER RESISTANCE**  
IPX4

**HeadLamp 800 Pro**

NEW

**High Performance Light With A High Performance Fit**

Go further and stay brighter with the Pro-Level HeadLamp 800. Utilizing 3D SlimFit construction, this hands-free light packs serious lumens and rechargeable power into a compact profile with an unprecedented no-bounce fit. With key features including a 800 lumen Burst Mode, Constant Brightness Setting, and a red rear light, this HeadLamp is ready to match your own epic performance.

-  **3D SlimFit Construction**
-  **USB Rechargeable**
-  **Constant Brightness Mode**
-  **Rear Red Flood & Strobe**
-  **Run Forever Cable Included**



  
HPC0201  
MIDNIGHT GREY



**TECH SPECS**

**LUMENS**

800 Lm BURST  
500 Lm HIGH  
5 Lm HOW

**BURN TIME (REGULATED)**

150 LO/7 HI

**BURN TIME (CONSTANT)**

150 LO/2 HI

**ADDITIONAL RESERVE**

+8 Hours at 5 Lm

**BATTERY**

3,000 mAh,  
USB Rechargeable

**WEIGHT**

150 g

**MODES**

 **Red Rear Flood + Dimming**

 **Red Rear Strobe**

 **Red Flood + Dimming**

 **White Strobe**

 **White Spot + Dimming**

**BEAM DISTANCE**

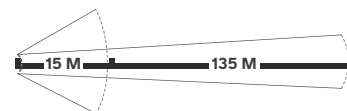

## INSIDE THE TECH: AlpenGlow

High-efficiency LEDs emit broad-spectrum light for more accurate color rendering

### CHROMAREAL LED TECHNOLOGY

ChromaReal Technology is a departure from the colder blue lights typically found among many portable lanterns. It helps colors pop and allows finishes to have more depth and luster. ChromaReal is especially helpful with nighttime cooking.

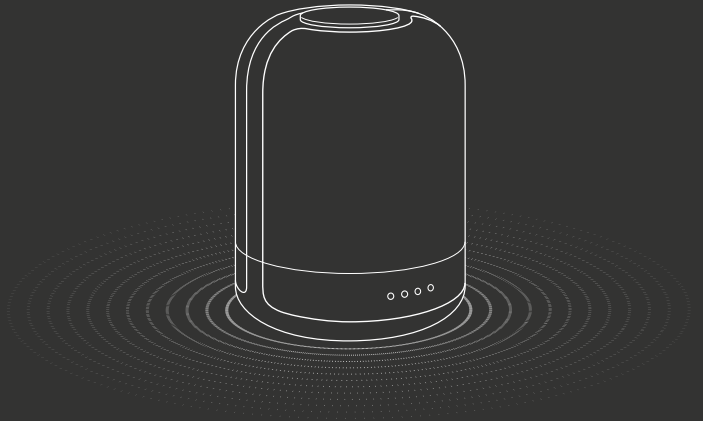

**AlpenGlow 250**

LNA0100

**Feel At Home With Nature - Inspired Light**

High efficiency meets high ambiance with this nature-inspired portable lantern. Combining ChromaReal LED technology with ergonomic user-friendly design, chose from a mix of warm, cool, and color tones to match the mood of your environment.

**Cool, Warm, & Color Modes****ChromaReal LED Technology****Rechargeable 3,200 mAh Battery Offers Charge Out****TECH SPECS****LUMENS**

250 Lm

**INPUTS/OUTPUTS**

Micro USB charge in USB A charge out

**LIGHTING MODES**

- Cool light, full (360 degree)
- ◐ Cool light, half (180 degree)
- Warm light, full (360 degree)
- ✦ Warm Candle Flicker
- 1 color light
- 1 color party mode
- Multicolor light (preset)
- Multicolor party mode

**BURN TIME (HRS)**

48 LO/4.5 HIGH

**BATTERY**

3,200 mAh, (11.1 Wh)

**IPX4 RATING**

IPX4

**DIMENSIONS**

95 x 75mm diameter

**WEIGHT**

215 g

**AlpenGlow 500**

LNB0100

**Feel At Home With Nature - Inspired Light**

Inspired by lighting you can only find in the great outdoors, the AlpenGlow lantern gives you the ability to create your own dusk and daylight feel no matter the time of day. Featuring ChromaReal LED technology, accurately render the colors in your environment with the glow of natural light; feeling more aurora borealis? Shake the lantern for an instant rotation of mesmerizing color. Highly responsive to your mood and setting, this lantern steps up the power of ambient lighting through smart tech and thoughtful design.

**Cool, Warm, & Color Modes****ChromaReal LED Technology****Rechargeable 6,400 mAh Battery Offers Charge Out****TECH SPECS****LUMENS**

500 Lm

**INPUTS/OUTPUTS**

Micro USB charge in USB A charge out

**LIGHTING MODES**

- Cool light, full (360 degree)
- ◐ Cool light, half (180 degree)
- Warm light, full (360 degree)
- ✦ Warm Candle Flicker
- 1 color light
- 1 color party mode
- Multicolor light (preset)
- Multicolor party mode

**BURN TIME (HRS)**

48 LO/4.5 HIGH

**BATTERY**

6,400 mAh, (22.2 Wh)

**IPX4 RATING**

IPX4

**DIMENSIONS**



136 x 97mm diameter

**WEIGHT**

390 g

### Multi-Room Solar Light & Power

Solar Home 625 is a self-contained system of solar lighting and charging that can turn any off-grid structure into an electrified home. The system combines functional and protective lighting (motion sensor included), USB charging, and radio and mp3 capabilities, creating a hub designed for everyday use. Ideal for cabins, van life, and hunting structures, the SolarHome 625 is a perfect entry into solar living with easy installation and flexible setup.

-  **6 Watt Solar System**
-  **Multi-Room Light**
-  **MP3 & Radio**
-  **Motion Sensor Light**
-  **Centralized Control Box**



#### TECH SPECS (ESTIMATED)

**BATTERY**

3800 mAh @ 6.4 V  
(24.3 Wh), LFP

**WEIGHT**

Control Box 610 g  
Lights (each) 230 g  
Solar Panel 720 g

**IN THE BOX**



Control Box  
2 Hanging Lights  
1 Security/Motion Light  
1 Solar Panel  
USB Device Adapter (micro, USB-C, 3.5mm DC)  
Mounting Hardware

### SiteLight String

SLB0200

#### SiteLight Series

BioLite's daisy-chainable SiteLights offer easy overhead lighting and can be run from any USB power source, including BioLite lanterns and powerbanks.

-  **USB Adapter Included**
-  **Chainable**
-  **Compact, Packable Design**



#### TECH SPECS

**LUMENS**

150 Lm  
(in 4 lights)

**CORD LENGTH**

3 m

**WEIGHT**

80 g

**PACKED DIMENSIONS**

47 x 47 x 70 mm

## Contact Details

Burton McCall Limited  
163 Parker Drive, Leicester LE4 0JP

Tel Main Switchboard: 0116 234 4600  
[www.burton-mccall.co.uk](http://www.burton-mccall.co.uk)

**f** @BTNMCCALL  
**t** @burtonmccallltd  
**@** @burtonmccallltd

## Sales Office

Tel: 0116 234 4611/4622  
Email: [sales@burton-mccall.com](mailto:sales@burton-mccall.com)

## Customer Services

Tel: 0116 234 4646  
Email: [customerservices@burton-mccall.com](mailto:customerservices@burton-mccall.com)

