



Electric Ceramic Cooktop

Installation Instructions

Available Models
CH30BF/CH77BF



1 (844) 538-7890

 www.gaslandchef.com

 support@gaslandchef.com

 8350 Patriot Blvd STE B, N. Charleston, SC 29418

Safety Warning

Your safety is important to us. Please read this information before using your cooktop.

Installation

Electrical Shock Hazard

- Disconnect the appliance from the main electricity supply before carrying out any work or maintenance on it.
- Connection to a good earth wiring system is essential and mandatory.
- Alterations to the domestic wiring system must only be made by a qualified electrician.
- Failure to follow this advice may result in electrical shock or death.

Cut Hazard

- Take care - panel edges are sharp.
- Failure to use cautiously could result in injury or cuts.

Important Safety Instructions

- Read these instructions carefully before installing or using this appliance.
- No combustible material or products should be placed on this appliance at any time.
- Please make this information available to the person who responsible for installing the appliance as it could reduce your installation costs.
- In order to avoid a hazard, this appliance must be installed according to these instructions for installation.
- This appliance is to be properly installed and earthed only by a suitable qualified technician.



- This appliance should be connected to a circuit which incorporates an isolating switch providing full disconnection from the power supply.
- Failure to install the appliance correctly could invalidate any warranty or liability claims.

Operation And Maintenance

Electrical Shock Hazard

- Do not cook on a broken or cracked cooktop. If the cooktop surface should break or crack, switch the appliance off immediately at the main power supply and contact a qualified technician.
- Switch the cooktop off at the wall before cleaning or maintenance.
- Failure to follow this advice may result in electrical shock or death.

Health Hazard

- This appliance complies with electromagnetic safety standards.

Scald Hazard

- During use, accessible parts of this appliance will become hot enough to cause burns.
- Do not let your body, clothing or any item other than suitable cookware contact the ceramic glass until the surface is cool.
- Metallic objects such as knives, forks, spoons and lids should not be placed on the cooktop surface since they can get hot.
- Keep children away.
- Handles of saucepans may be hot to touch. Make sure saucepan handles do not overhang other cooking zones that are on. Also, keep the handles out of reach of children.
- Failure to follow this advice could result in burns and scalds.



Important Safety Instructions

- Never leave the appliance unattended when in use. Boil over causes smoking and greasy spillovers that may ignite.
- Never use your appliance as a work or storage surface.
- Never leave any objects or utensils on the appliance.
- Never use your appliance for warming or heating the room.
- After use, always turn off the cooking zones and the cooktop as described in this manual.
- Do not allow children to play with the appliance or sit, stand, or climb on it.
- Do not store items of interest to children in cabinets above the appliance. Children who climbing on the cooktop could be seriously injured.
- Do not leave children alone or unattended in the area where the appliance is in use.
- Children or persons with a disability which limits their ability to use the appliance should have a responsible and competent person to instruct them in its use. The instructor should be confirmed that they can use the appliance without doing danger to themselves or their surroundings.
- Do not repair or replace any part of the appliance unless specifically recommended in the manual. All other servicing should be done by a qualified technician.
- Do not use a steam cleaner to clean your cooktop.
- Do not place or drop heavy objects on your cooktop.
- Do not stand on your cooktop.
- Do not use pans with jagged edges or drag pans across the ceramic glass surface as this can scratch the glass.
- Do not use scourers or any other harsh abrasive cleaning agents to clean your cooktop, as these can scratch the ceramic glass.
- If the supply cord is damaged, it must be replaced by the manufacturer, its service agent or similarly qualified persons in order to avoid a hazard.
- This appliance is intended to be used in household and similar applications such as: staff kitchen areas in shops, offices and other working environments, farm houses, by clients in hotels, motels and other residential type environments, bed and breakfast type environments.
- **WARNING:** The appliance and its accessible parts become hot during use. Care should be taken to avoid touching heating elements. Children less than 8 years of age shall be kept away unless continuously supervised.



- This appliance can be used by children aged from 8 years and above and persons with reduced physical, sensory or mental capabilities or lack of experience and knowledge if they have been given supervision or instruction concerning use of the appliance in a safe way and understand the hazards involved.
- Children shall not play with the appliance. Cleaning and user maintenance shall not be made by children without supervision.
- **WARNING:** Unattended cooking on a cooktop with fat or oil can be dangerous and may result in fire. Never try to extinguish a fire with water, but switch off the appliance and then cover flame e.g. with a lid or a fire blanket.
- **WARNING:** Danger of fire: do not store items on the cooking surfaces.
- **WARNING:** If the surface is cracked, switch off the appliance to avoid the possibility of electric shock, for cooktop surfaces of glass-ceramic or similar material protect live parts.
- A steam cleaner should not be used.
- The appliance is not intended to be operated by means of an external timer or separate remote-control system.

Congratulations

On the purchase of your new ceramic cooktop, we recommend that you spend some time to read this instruction/installation manual in order to fully understand how to correctly install and operate it. For installation, please read the installation section. Read all the safety instructions carefully before use and keep this instruction/installation manual for future reference.



Product Overview

Top view(CH30BF)

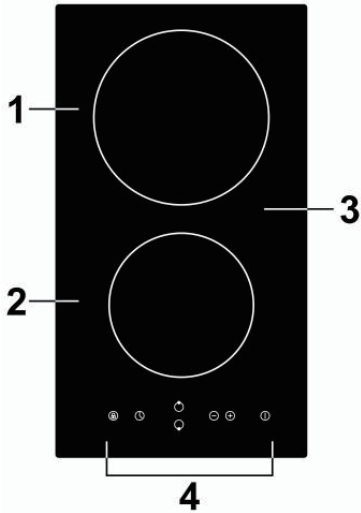

1. Max. 1800W zone
2. Max. 1200W zone
3. Glass plate
4. Control panel

Control panel(CH30BF)

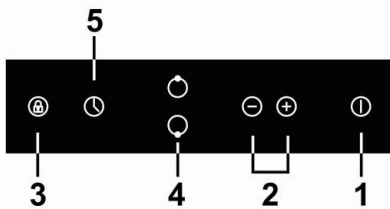

1. ON/OFF control
2. Power/Timer regulating control
3. Key lock control
4. Heating zone selection control
5. Timer control



Top view(CH77BF)

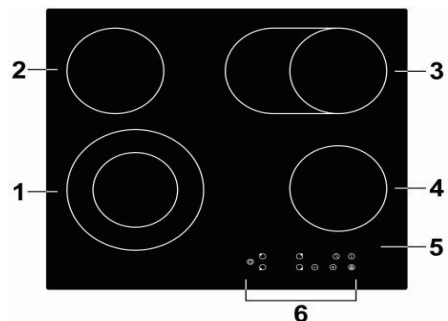

1. Max. 2200W(1000W) zone
2. Max. 1200W zone
3. Max. 2000W(1100W) zone
4. Max. 1200W zone
5. Glass plate
6. Control panel

Control panel(CH77BF)

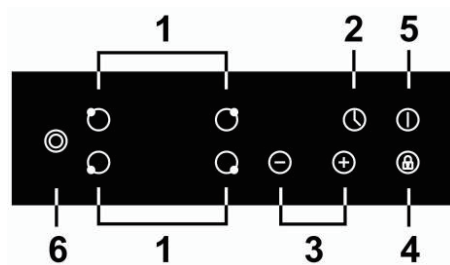

1. Heating zone selection control
2. Timer control
3. Power/Timer regulating control
4. Key lock control
5. ON/OFF control
6. Dual Zone



Product Information

The ceramic cooktop can meet different kinds of cuisine demands with its resistance wire heating, micro-computerized control and multi-power selection. It's an ideal really the optimal choice for modern families.

Working Principle

This ceramic cooktop directly employs resistance wire heating, and adjust the output power by the power regulation with the sensor touch controls.

Before Using Your New Ceramic Cooktop

- Read this guide, taking special note of the 'Safety Warnings' section.
- Remove any protective film that may still be on your ceramic cooktop.

Using The Touch Controls

- The controls respond to touch, so you don't need to apply any pressure.
- Use the ball of your finger, not its tip.
- You will hear a beep each time a touch is registered.
- Make sure the controls are always clean, dry and that there is no object covering them. Even a thin film of water may make the controls difficult to operate.

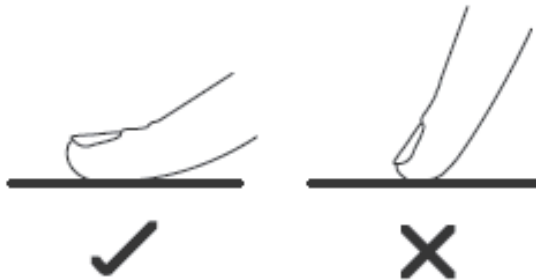

Choosing The Right Cookware

Do not use cookware with jagged edges or a curved base.



Make sure that the base of your pan is smooth, sits flat against the glass, and is the same size as the cooking zone. Always centre your pan on the cooking zone.

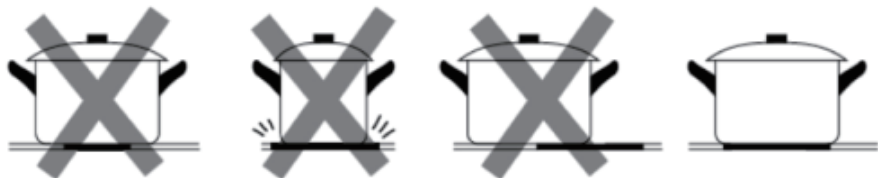

Always lift pans off the ceramic cooktop – do not slide, or they may scratch the glass.



Using Your Ceramic Cooktop(CH30BF)

To start cooking

After power on, the buzzer beeps once, all the indicators light up for 1 second then go out, indicating that the ceramic cooktop has entered the state of standby mode.

1. Touch the ON/OFF  control, all the indicators show “-”.



2. Place a suitable pan on the cooking zone that you hope to use.

Make sure the bottom of the pan and the surface of the cooking zone are clean and dry.

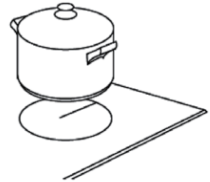

3. Touch the heating zone selection controls to select a heat setting by touching the “-” or “+” control.

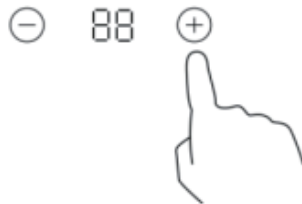

Using Your Ceramic Cooktop(CH77BF)

To start cooking

After power on, the buzzer beeps once, all the indicators light up for 1 second then go out, indicating that the ceramic cooktop has entered the state of standby mode.

1. Touch the ON/OFF  control, all the indicators show “-”.



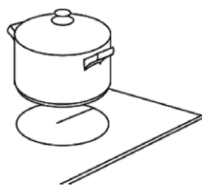

2. Place a suitable pan on the cooking zone that you hope to use.

Make sure the bottom of the pan and the surface of the cooking zone are clean and dry.

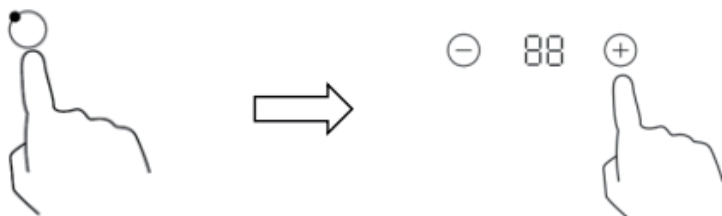

3. Touch the heating zone selection controls to select a heat setting by touching the “-” or “+” control.



4. You can activate the double zone by pressing  .
When the double zone is working, you can turn it off by pressing  .



When You Have Finished Cooking

1. Touch the heating zone selection controls and touch the “-” control to turn the cooking zone off by scrolling down to “0”.



2. Turn the whole cooktop off by touching the ON/OFF control.



3. Beware of hot surfaces

“H” will show which cooking zone is hot to touch. It will disappear when the surface has cooled down to a safe temperature. It can also be used as an energy saving function if you want to heat further pans, use the hotplate that is still hot.



Locking The Controls

- You can lock the controls to prevent unintended use, for example children accidentally turning the cooking zones on.
- When the controls are locked, all the controls except the ON/OFF and keylock controls are disabled.

To lock the controls

Touch the keylock control, the timer indicator will show “Lo” and the cooktop will be locked.

To unlock the controls

1. Make sure the ceramic cooktop is turned on.
2. Touch and hold the keylock control for a while.
3. You can now start using your ceramic cooktop again.





When the cooktop is in the lock mode, all the controls are disable except the ON/OFF and keylock controls, you can always turn the cooktop off with the ON/OFF control in an emergency, but you shall unlock the cooktop first in the next operation.

Over-Temperature Protection

A temperature sensor equipped can monitor the temperature inside the ceramic cooktop. When an excessive temperature is monitored, the ceramic cooktop will stop operation automatically.

Residual Heat Warning

When the cooktop has been operating for some time, there will be some residual heat. The letter “H” appears to warn you to keep away from it.

Auto Shutdown Protection

Another safety feature of the cooktop is auto shutdown. This occurs whenever you forget to switch off a cooking zone. The default shutdown times are shown in the table below:

Power level	1	2	3	4	5	6	7	8	9
Default working timer(hour)	8	8	8	4	4	4	2	2	2

Using The Timer

You can use the timer in two different ways:

- You can use it as a minute minder. In this way, the timer will not turn any cooking zone off when the set time is up.
- You can set it to turn one cooking zone off after the set time is up.
- You can set the timer up to 99 minutes.



Using The Timer As A Minute Minder

If you are not selecting any cooking zone

1. Make sure the cooktop is turned on.

Note: You can use the minute minder even if you're not selecting any cooking zone.

2. Touch the timer control, the minder indicator will start flashing and "30" will show in the timer display.



3. Set the time by touching the "-" or "+" control of the timer.

Hint: Touch the "-" or "+" control of the timer once to decrease or increase by 1 minute. Touch and hold the "-" or "+" control of the timer to decrease or increase by 10 minutes.

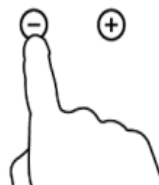

4. When the time is set, it will begin to count down immediately. The display will show the remaining time and the timer indicator will flash for 5 seconds.

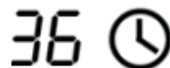

5. Buzzer will beep for 30 seconds and the timer indicator shows "--" when the setting time finished.

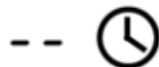

Note: The cooktop will continue to cook, this timer function is a minute minder only, it does not turn the cooktop on or off.

Setting The Timer To Turn One Cooking Zone Off

1. Touch the heating zone selection control that you want to set the timer for. Touch the timer and then adjust the time by touching the "-" or "+" controls.



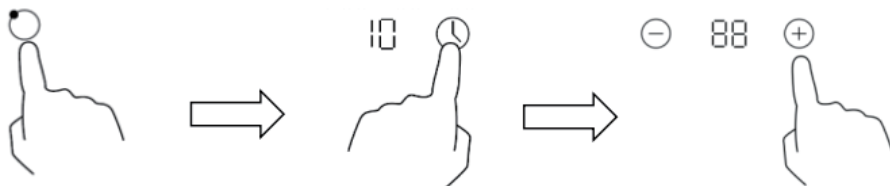

Hint: Touch the “-” or “+” control of the timer once will decrease or increase by 1 minute.

Touch and hold the “-” or “+” control of the timer will decrease or increase by 10 minutes.



2. Touch the “-” control, if the “00” will show in the minute display, the timer is cancelled.

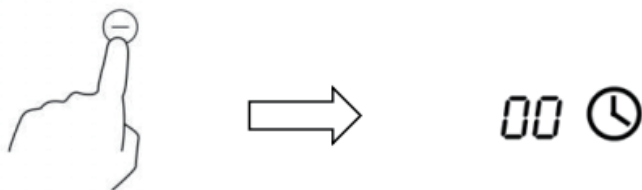

3. When the time is set, it will begin to count down immediately. The display will show the remaining time and the timer indicator flash for 5 seconds.



Note: The red dot next to power level indicator will illuminate indicating that zone is selected.

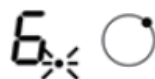

4. When cooking timer expires, the corresponding cooking zone will be switch off automatically.

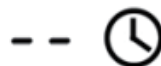

 Other cooking zones will keep operating if they are turned on previously.



Setting The Timer To Turn More Than One Cooking Zone Off

1. If more than one heating zones use this function, the timer indicator will show the lowest time. (e.g. zone 2# setting time of 3 minutes, zone 3# setting time of 6 minutes, the timer indicator shows "3".)

Note: The red dot next to power level indicator will flash.

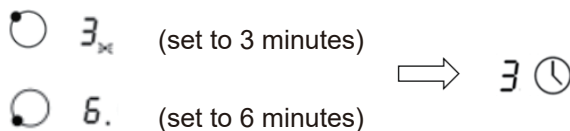

2. When cooking timer expires, the corresponding cooking zone will be switch off automatically.



Cooking Guidelines



Take care when frying as the oil and fat heat up very quickly, especially if you're using power boost. Oil and fat at extremely high temperatures will ignite spontaneously and this presents a serious fire risk.

Cooking Tips

- When food comes to the boil, reduce the temperature setting.
- Using a lid will reduce cooking times and save energy by retaining the heat.
- Minimize the amount of liquid or fat to reduce cooking times.
- Start cooking on a high setting and reduce the setting when the food has heated through.



Simmering, cooking rice

- Simmering occurs below boiling point, at around 85°C(185°F), when bubbles are just rising occasionally to the surface of the cooking liquid. It is the key to delicious soups and tender stews because the flavor develop without overcook ing the food. You should also cook egg-based and flour-thickened sauces below boiling point.
- Some tasks, including cooking rice by the absorption method, may require a setting higher than the lowest setting to ensure the food is cooked properly in the time recommended.

Searing steak

To cook juicy flavorsome steaks:

1. Stand the meat at room temperature for about 20 minutes before cooking.
2. Heat up a heavy-based frying pan.
3. Brush both sides of the steak with oil. Drizzle a small amount of oil into the hot pan and then lower the meat onto the hot pan.
4. Turn the steak only once during cooking. The exact cooking time will depend on the thickness of the steak and your taste. Time may vary from 2 – 8 minutes per side. Press the steak to gauge how cooked it is the firmer it feels the more “well done” it will be.
5. Leave the steak to rest on a warm plate for a few minutes to allow it to relax and become tender before serving.

For stir-frying

1. Choose a ceramic compatible flat-based wok or a large frying pan.
2. Have all the ingredients and equipment ready. Stir-frying should be quick. If cooking large quantities, cook the food in several smaller batches.
3. Preheat the pan briefly and add two tablespoons of oil.
4. Cook any meat first, put it aside and keep warm.
5. Stir-fry the vegetables. When they are hot but still crisp, turn the cooking zone to a lower setting, return the meat to the pan and add your sauce.
6. Stir the ingredients gently to make sure they are heated through.
7. Serve immediately.



Heat Settings

The settings below are guidelines only. The exact setting will depend on several factors including your cookware and the amount you are cooking. Experiment with the ceramic cooktop to find the settings that best suit you.

Heat setting	Suitability
1 - 2	<ul style="list-style-type: none"> • Delicate warming for small amounts of food • Melting chocolate, butter, and foods that burn quickly • Gentle simmering • Slow warming
3-4	<ul style="list-style-type: none"> • Reheating • Rapid simmering • Cooking rice
5-6	<ul style="list-style-type: none"> • Pancakes
7-8	<ul style="list-style-type: none"> • Sauteing • Cooking pasta
9	<ul style="list-style-type: none"> • Stir-frying • Searing • Bringing soup to the boil • Boiling water

Care And Cleaning

What?	How?	Important!
Spillovers on the touch controls	<ol style="list-style-type: none"> 1. Switch the power to the cooktop off. 2. Soak up the spill. 3. Wipe the touch control area with a clean damp sponge or cloth. 4. Wipe the area completely dry with a paper towel. 5. Switch the power to the cooktop back on. 	<ul style="list-style-type: none"> • The cooktop may beep and turn itself off, and the touch controls may not function while there is liquid on them. Make sure you wipe the touch control area dry before turning the cooktop back on.



<p>Everyday soiling on glass(fingerprints, marks, stains left by food or non-sugary spillovers on the glass)</p>	<ol style="list-style-type: none"> 1. Switch off the power to the cooktop. 2. Apply a cooktop cleaner while the glass is still warm but not hot. 3. Rinse and wipe dry with a clean cloth or paper towel. 4. Switch on the power to the cooktop. 	<ul style="list-style-type: none"> • When the power to the cooktop is switched off, there will be no ‘hot surface’ indication but the cooking zone may still be hot! Take extreme care. • Heavy-duty scourers, some nylon scourers and harsh/abrasive cleaning agents may scratch the glass. Always read the label to check if your cleaner or scourer is suitable. • Never leave cleaning residue on the cooktop: the glass may become stained.
<p>Boilovers, melts, and hot sugary spills on the glass</p>	<p>Remove these immediately with a fish slice, palette knife or razor blade scraper suitable for ceramic glass cooktops, but beware of hot cooking zone surfaces:</p> <ol style="list-style-type: none"> 1. Switch off the power to the cooktop. 2. Hold the blade or utensil at a 30° angle and scrape the soiling or spill to a cool area of the cooktop. 3. Clean the soiling or spill up with a dish cloth or paper towel. 4. Follow steps 2 to 4 for “Everyday soiling on glass” above. 	<ul style="list-style-type: none"> • Remove stains left by melts and sugary food or spillovers as soon as possible. If left to cool down on the glass, they may be difficult to remove or even permanently damage the glass surface. • Cut hazard: when the safety cover is retracted, the blade in a scraper is razor-sharp. Use with extreme care and always store safely and out of reach of children.



Hints And Tips

Problem	Possible causes	What to do
The cooktop cannot be turned on.	No power.	Make sure the cooktop is connected to the power supply and that it is switched on. Check whether there is a power outage in your home or area. If you've checked everything and the problem persists, call a qualified technician.
The glass is being scratched.	Rough-edged cookware.	Use cookware with flat and smooth bases. See "Choosing The Right Cookware".
	Unsuitable, abrasive scourer or cleaning products being used.	See "Care And Cleaning".
The touch controls are unresponsive.	The controls are locked.	Unlock the controls. See section "Using Your Ceramic Cooktop" for instructions.
Some pans make crackling or clicking noises.	This may be caused by the construction of your cookware (layers of different metals vibrating differently).	This is normal for cookware and does not indicate a fault.

Please do not disassemble the unit by yourself to avoid any dangers and damages to the ceramic cooktop.

Technical Specification

Model	CH30BF	CH77BF
Cooking Zones	2 Zones	4 Zones
Supply Voltage	220-240V~	220-240V~
Frequency	50-60Hz	50-60Hz
Rating Power	2745-3267W	6039-7186W
Product Size L×W×H	11.5" x 20.5" x 2.0"	30.4" x 20.5" x 2.0"
Built-in Dimension A×B	10.6" x 19.8"	22.2" x 19.4"

Weight and dimensions are approximate. As we continually strive to improve our products we may change specifications and designs without prior notice.



Installation

Cutting Out Work Surface

Cut out the work surface according to the sizes shown in the drawing. For the purpose of installation and use, a minimum of 2.0" space shall be preserved around the hole.

Be sure the thickness of the work surface is at least 1.2". Please select heat-resistant work surface material to avoid larger deformation caused by the heat radiation from the hotplate. As shown below:

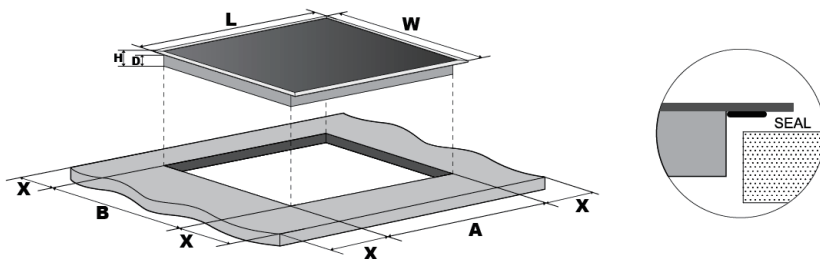

Model	L	W	H	D	A	B	X
CH30BF	11.5"	20.5"	2.0"	1.9"	10.6"	19.8"	minimum 2.0"
CH77BF	30.4"	20.5"	2.0"	1.9"	22.2"	19.5"	minimum 2.0"

Under any circumstances, make sure the ceramic cooktop is well ventilated and the air inlet and outlet are not blocked. Ensure the ceramic cooktop is in good work state. As shown on the next page.

 **Note:** The safety distance between the cooktop and the cupboard above the cooktop should be at least 30.0".



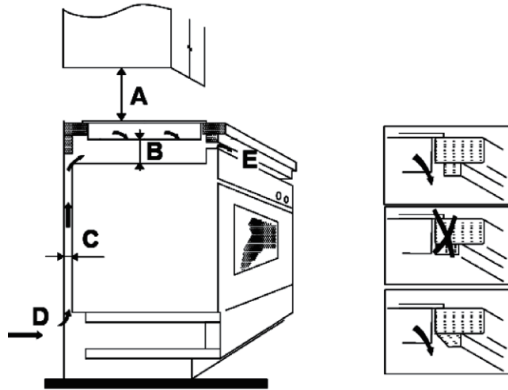

A	B	C	D	E
30.0"	2.0" mini	0.8" mini	Air intake	Air exit 0.2"

Before Locating The Fixing Brackets

1. The cooktop should be placed on a stable, smooth surface (use the packaging). Do not apply force onto the controls protruding from the cooktop.
2. Fix the cooktop on the work surface by screw two brackets on the left side and two brackets on the right side of cooktop (see below picture) after installation.

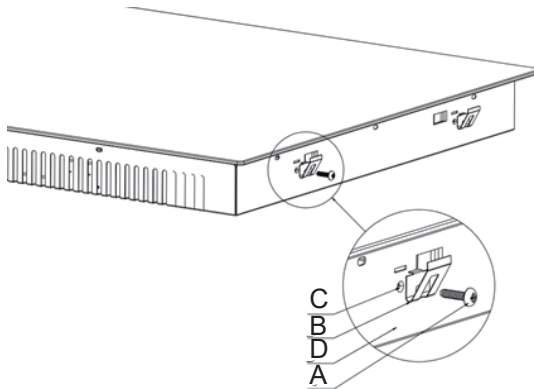

A	B	C	D
screw	bracket	screw hole	base



3. Insert the appliance into the installation opening.

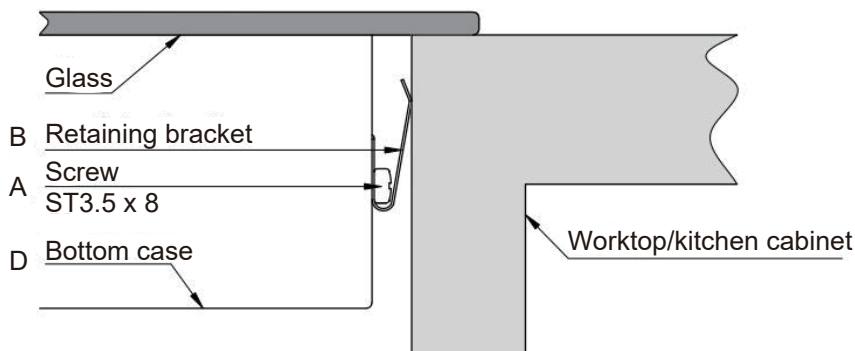

Cautions

1. The ceramic cooktop must be installed by qualified personnel or technicians. We have professionals at your service. Please never conduct the operation by yourself.
2. The ceramic cooktop shall not be mounted to cooling equipment, dishwashers and rotary dryers.
3. The ceramic cooktop shall be installed as the manual required so better heat radiation can be ensured to enhance its reliability.
4. The wall and induced heating zone above the work surface shall withstand heat.
5. To avoid any damage, the sandwich layer and adhesive must be resistant to heat.
6. A steam cleaner should not be used.
7. This ceramic cooktop can only be connected to a supply with system impedance no more than 0.427 ohm. If necessary, please consult your supply authority for system impedance information.



Connecting The Cooktop To The Main Power Supply

The power supply should be connected in compliance with the relevant standard, or connected to a single-pole circuit breaker. The method of connection is shown below.

CH30BF

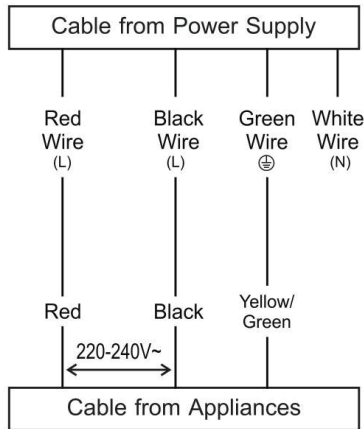

CH77BF

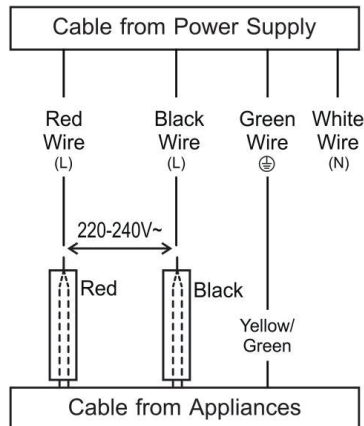

1. If the cable is damaged or needs replacing, this should be done by an after-sales technician using the proper tools to avoid any accidents.
2. If the appliance is directly connected to the main supply, an omnipolar circuit breaker must be installed with a minimum gap of 0.11" between the contacts.
3. The installer must ensure that the correct electrical connection has been made and that it complies with safety regulations.
4. The cable must not be bent or compressed.
5. The cable must be checked regularly and only replaced by a properly qualified person.



DISPOSAL: Do not dispose this product as unsorted municipal waste. Collecting such waste separately for special treatment is necessary.

This appliance is labeled in compliance with European directive 2002/96/EC for Waste Electrical and Electronic Equipment(WEEE). By ensuring that this appliance is disposed of correctly, you will help prevent any possible damage to the environment and to human health, which might otherwise be caused if it were disposed of in the wrong way.

The symbol on the product indicates that it may not be treated as normal household waste. It should be taken to a collection point for the recycling of electrical and electronic goods.

This appliance requires specialist waste disposal.

For more detailed information about treatment, recovery and recycling of this product, please contact your local city office, your household waste disposal service or the shop where you purchased the product.



Error code	Causes	Measurement
E1	Short circuit of heating element sensor.	Shut down and restart the cooktop or contact the seller.
E2	Heating element sensor damaged.	Please contact the seller.
E3	The temperature of cooktop surface is too high.	Turn off the cooktop to let it cool down. Then restart the cooktop.
E4	Open circuit of heating element sensor.	Shut down and restart the cooktop, or contact the seller.





GASLAND chef

1 (844)538-7890

www.gaslandchef.com

