



IH SERIES

# ELECTRIC INDUCTION COOKTOP

USER MANUAL

## Safety Warning

Your safety is important to us. Please read this information before using your cooktop.

## Installation

### Electrical Shock Hazard

- Disconnect the appliance from the main electricity supply before carrying out any work or maintenance on it.
- Connection to a good earth wiring system is essential and mandatory.
- Alterations to the domestic wiring system must only be made by a qualified electrician.
- Failure to follow this advice may result in electrical shock or death.

### Cut Hazard

- Take care – panel edges are sharp.
- Failure to use cautiously could result in injury or cuts.

## Important Safety Instructions

- Read these instructions carefully before installing or using this appliance.
- No combustible material or products should be placed on this appliance at any time.
- Please make this information available to the person who responsible for installing the appliance as it could reduce your installation costs.
- In order to avoid a hazard, this appliance must be installed according to these instructions for installation.
- This appliance is to be properly installed and earthed only by a suitable qualified technician.
- This appliance should be connected to a circuit which incorporates an isolating

switch providing full disconnection from the power supply.

- Failure to install the appliance correctly could invalidate any warranty or liability claims.

## **Operation And Maintenance**

### **Electrical Shock Hazard**

- Do not cook on a broken or cracked cooktop. If the cooktop surface should break or crack, switch the appliance off immediately at the main power supply and contact a qualified technician.
- Switch the cooktop off at the wall before cleaning or maintenance.
- Failure to follow this advice may result in electrical shock or death.

### **Health Hazard**

- This appliance complies with electromagnetic safety standards.
- However, persons with cardiac pacemakers or other electrical implants (such as insulin pumps) must consult with their doctor or implant manufacturer before using this appliance to make sure that their implants will not be affected by the electromagnetic field.
- Failure to follow this advice may result in death.

### **Scald Hazard**

- During use, accessible parts of this appliance will become hot enough to cause burns.
- Do not let your body, clothing or any item other than suitable cookware contact the ceramic glass until the surface is cool.
- Metallic objects such as knives, forks, spoons and lids should not be placed on the cooktop surface since they can get hot.
- Keep children away.
- Handles of saucepans may be hot to touch. Make sure saucepan handles do not overhang other cooking zones that are on. Also, keep the handles out of reach of children.
- Failure to follow this advice could result in burns and scalds.

## Cut Hazard

- Take care – panel edges are sharp.
- Failure to use caution could result in injury or cuts

## Important Safety Instructions

- Never leave the appliance unattended when in use. Boil over causes smoking and greasy spillovers that may ignite.
- Never use your appliance as a work or storage surface.
- Never leave any objects or utensils on the appliance.
- Do not place or leave any magnetisable objects (e.g. credit cards, memory cards) or electronic devices (e.g. computers, MP3 players) near the appliance, as they may be affected by its electromagnetic field.
- Never use your appliance for warming or heating the room.
- After use, always turn off the cooking zones and the cooktop as described in this manual (i.e. by using the touch controls). Do not rely on the pan detection feature to turn off the cooking zones when you remove the pans.
- Do not allow children to play with the appliance or sit, stand, or climb on it.
- Do not store items of interest to children in cabinets above the appliance. Children climbing on the cooktop could be seriously injured.
- Do not leave children alone or unattended in the area where the appliance is in use.
- Children or persons with a disability which limits their ability to use the appliance should have a responsible and competent person to instruct them in its use. The instructor should be satisfied that they can use the appliance without danger to themselves or their surroundings.
- Do not repair or replace any part of the appliance unless specifically recommended in the manual. All other servicing should be done by a qualified technician.
- Do not use a steam cleaner to clean your cooktop.
- Do not place or drop heavy objects on your cooktop.
- Do not stand on your cooktop.
- Do not use pans with jagged edges or drag pans across the Induction glass surface as this can scratch the glass.

- Do not use scourers or any other harsh abrasive cleaning agents to clean your cooktop, as these can scratch the Induction glass.
- If the supply cord is damaged, it must be replaced by the manufacturer, its service agent or similarly qualified persons in order to avoid a hazard.
- This appliance is intended to be used in household and similar applications such as: staff kitchen areas in shops, offices and other working environments; farm houses; by clients in hotels, motels and other residential type environments; bed and breakfast type environments.
- **WARNING:** The appliance and its accessible parts become hot during use. Care should be taken to avoid touching heating elements. Children less than 8 years of age shall be kept away unless continuously supervised.
- This appliance can be used by children aged from 8 years and above and persons with reduced physical, sensory or mental capabilities or lack of experience and knowledge if they have been given supervision or instruction concerning use of the appliance in a safe way and understand the hazards involved.
- Children shall not play with the appliance. Cleaning and user maintenance shall not be made by children without supervision.
- **WARNING:** Unattended cooking on the cooktop with fat or oil can be dangerous and may result in fire. Never try to extinguish a fire with water, but switch off the appliance and then cover flame with a lid or a fire blanket.
- **WARNING:** Danger of fire: do not store items on the cooking surfaces.
- **WARNING:** If the surface is cracked, switch off the appliance to avoid the possibility of electric shock.
- A steam cleaner is not to be used.
- The appliance is not intended to be operated by means of an external timer or separate remote-control system.

**CAUTION:** The cooking process has to be supervised. A short term cooking process has to be supervised continuously.

**WARNING:** In order to prevent tipping of the appliance, this stabilizing means must be installed. Refer to the instructions for installation. Use only cooktop guards designed by the manufacturer of the cooking appliance or indicated by the manufacturer of the appliance in the instruction for use as suitable or cooktop guards incorporated in the appliance. The use of inappropriate guards can cause accidents. This appliance incorporates an earth connection for functional purposes only.

## Congratulations

On the purchase of your new Induction cooktop. We recommend that you spend some time to read this Instruction/Installation Manual in order to fully understand how to install correctly and operate it. For installation, please read the installation section. Read all the safety instructions carefully before use and keep this Instruction/Installation Manual for future reference.

## Product Overview

Top view (IH30BF)

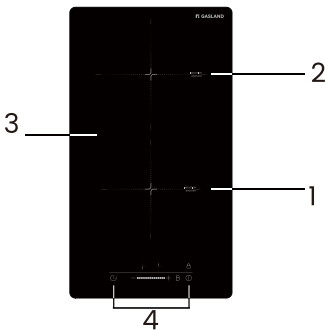

Control panel (IH30BF)

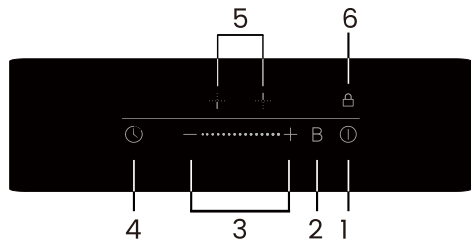

1. Max. 1200W boost 1500W zone
2. Max. 2000W boost 2300W zone
3. Glass plate
4. Control panel

1. ON/OFF control
2. Boost function control
3. Power/Timer regulating control
4. Timer control
5. Heating zone selection controls
6. Keylock control

Top view (IH60BF)

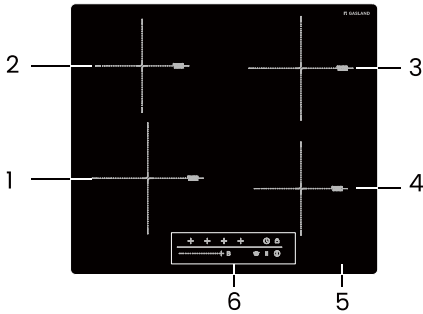

Control panel (IH60BF)

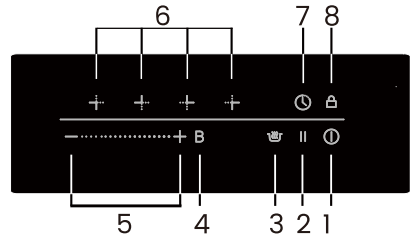

1. Max. 2300W boost 2600W zone
2. Max. 1200W boost 1500W zone
3. Max. 2000W boost 2300W zone
4. Max. 1200W boost 1500W zone
5. Glass plate
6. Control panel

1. ON/OFF control
2. Stop&go
3. Warming functions control
4. Boost function control
5. Power/Timer regulating control
6. Heating zone selection controls
7. Timer control
8. Key lock control

Top view (IH90BFN1)

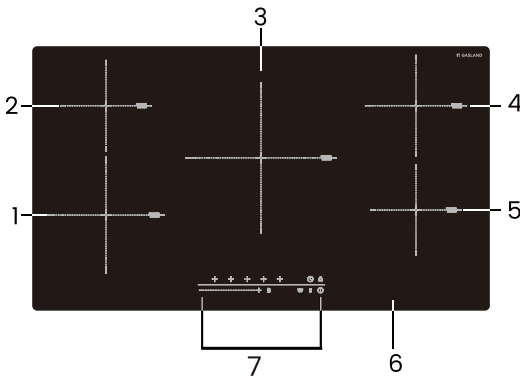

1. Max. 2300W boost 2600W zone
2. Max. 1200W boost 1500W zone
3. Max. 2300W boost 3000W zone
4. Max. 2000W boost 2300W zone
5. Max. 1200W boost 1500W zone
6. Glass plate
7. Control panel

Control panel (IH90BFN1)

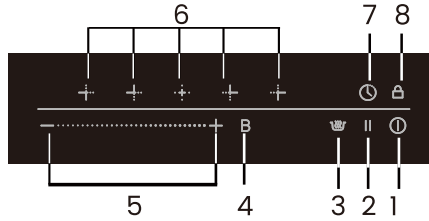

1. ON/OFF control
2. Stop&go
3. Warming functions control
4. Boost function control
5. Power/Timer regulating control
6. Heating zone selection controls
7. Timer control
8. Key lock control

## A Word On Induction Cooking

Induction cooking is a safe, advanced, efficient, and economical cooking technology. It works by electromagnetic vibrations generating heat directly in the pan, rather than indirectly through heating the glass surface. The glass becomes hot only because the pan eventually warms it up.

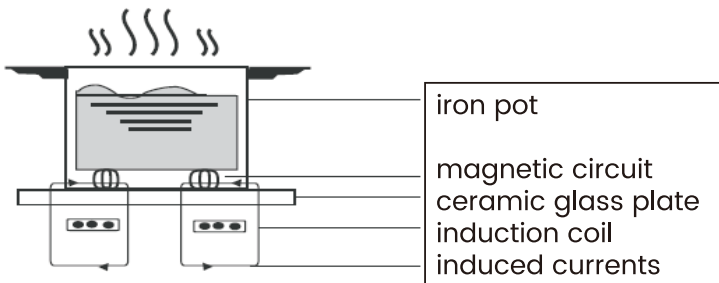



## Before Using Your New Induction Cooktop

- Read this guide, taking special note of the 'Safety Warnings' section.
- Remove any protective film that may still be on your induction cooktop.

## Using The Touch Controls

- The controls respond to touch, so you don't need to apply any pressure.
- Use the ball of your finger, not its tip.
- You will hear a beep each time a touch is registered.
- Make sure the controls are always clean, dry, and that there is no object (e.g. a utensil or a cloth) covering them. Even a thin film of water may make the controls difficult to operate.

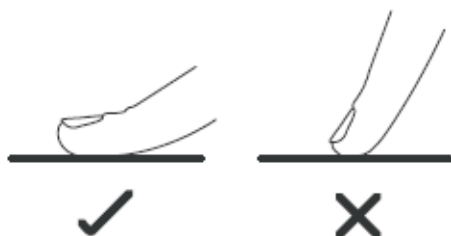

## Choosing The Right Cookware

- ⚠ Only use cookware with a base suitable for induction cooking. Look for the induction symbol on the packaging or on the bottom of the pan.
- You can check whether your cookware is suitable by carrying out a magnet test. Move a magnet towards the base of the pan. If it is attracted, the pan is suitable for induction cooking.
- If you do not have a magnet:
  1. Put some water in the pan you want to check.
  2. If  does not flash in the display and the water is heating, the pan is suitable.



- Cookware made from the following materials is not suitable: pure stainless steel, aluminium or copper without a magnetic base, glass, wood, porcelain, ceramic, and earthenware.

Do not use cookware with jagged edges or a curved base.



Make sure that the base of your pan is smooth, sits flat against the glass, and is the same size as the cooking zone. Use pans whose diameter is as large as the graphic of the zone selected. Using a pot a slightly wider energy will be used at its maximum efficiency. If you use smaller pot efficiency could be less than expected. Pot less than 5<sup>1</sup>/<sub>2</sub>in could be undetected by the cooktop. Always centre your pan on the cooking zone.

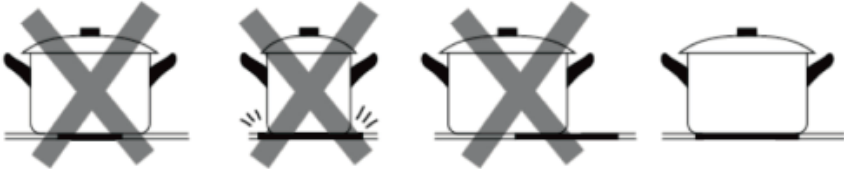

Always lift pans off the induction cooktop – do not slide, or they may scratch the glass.

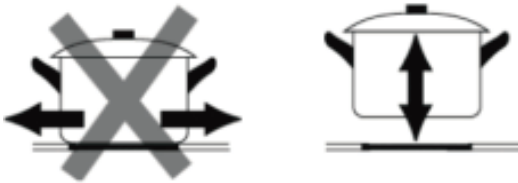

# Using Your Induction Cooktop

To start cooking

1. Touch the ON/OFF control.

After power on, the buzzer beeps once, all displays show “-” or “--”, indicating that the induction cooktop has entered the state of standby mode.

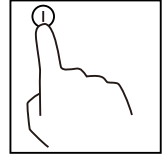

2. Place a suitable pan on the cooking zone that you wish to use.

- Make sure the bottom of the pan and the surface of the cooking zone are clean and dry.

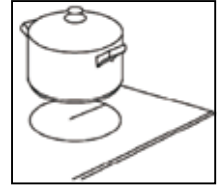

3. Touching the power regulating control and an indicator next to the key will flash.

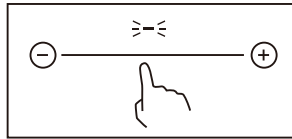

4. Set a power level by slide along the “-” control

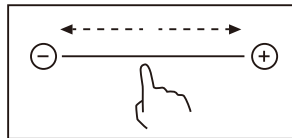

- If you don't set the power within 1 minute, the cooktop will automatically switch off. You will need to start again at step 1.
- You can modify the heat setting at any time during cooking.
- If slide along the “-”, power will vary from stage to stage .  
 Press “-”, power will decrease by one stage each time till stage 0.  
 Press “+”, power will increase by one stage each time till stage 9.

## If The Display Flashes $\geq \underline{\quad} \leq$ Alternately With The Heat Setting

This means that:

- You have not placed a pan on the correct cooking zone or,
- The pan you're using is not suitable for induction cooking or,
- The pan is too small or not properly centred on the cooking zone.

No heating takes place unless there is a suitable pan on the cooking zone. display will automatically turn off after 1 minutes if no suitable pan is placed on it.

## When You Have Finished Cooking

1. Touching the heating zone selection control that you wish to switch off.

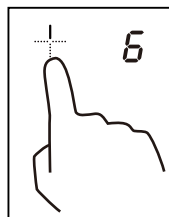

2. Turn the cooking zone off by touching the “-” and scrolling down to “0”.

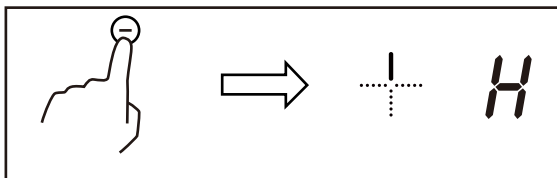

Or slide along the “-” to the left point, and then touch the “-”

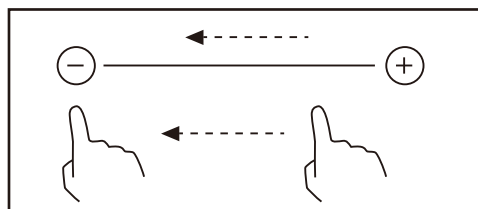

Make sure the power display shows “0”, then shows “H”.



3. Turn the whole cooktop off by touching the ON/OFF control.

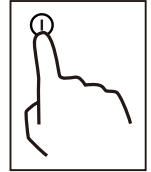

4. Beware of hot surfaces

“H” will show which cooking zone is hot to touch. It will disappear when the surface has cooled down to a safe temperature. It can also be used as an energy saving function if you want to heat further pans, use the hotplate that is still hot.



## Using The Boost Function

Boost function is the function that one zone rising to a larger power in one second and lasting for 5 minutes. Then you can get a more powerful and faster cooking.

## Using The Boost To Get Larger Power

1. Touch the power regulating control, an indicator above the key will flash.

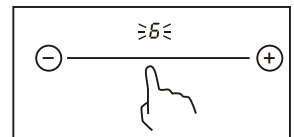

2. Touch the “B” button, the heating zone will begin to work at boost mode. The power display will show “P” to indicate that the zone is boosting.

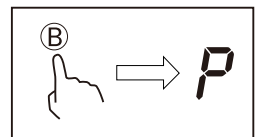

2. Touch the “B” button, the heating zone will begin to work at boost mode. The power display will show “P” to indicate that the zone is boosting.



4. If you want to cancel the Booster during these 5 minutes. The heating zone will go back to the power stage.

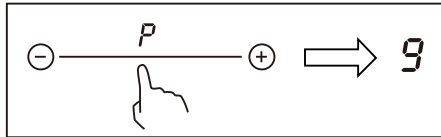

## Locking The Controls

- You can lock the controls to prevent unintended use (for example children accidentally turning the cooking zones on).
- When the controls are locked, all the controls except the ON/OFF control are disabled.

To lock the controls

Touch and hold the keylock control for 3 seconds. The timer indicator will show “Lo”.

To unlock the controls





1. Make sure the cooktop is turned on.
2. Touch and hold the keylock control for 3 seconds.
3. You can now start using your cooktop.



When the cooktop is in the lock mode, all the controls are disabled except the ON/OFF, you can always turn the cooktop off with the ON/OFF control in an emergency, but you shall unlock the cooktop first in the next operation.



## Using The pause function: Stop & Go (For IH60BF / IH90BFN1)

The pause function can be used at any time during cooking. Allows Stop the hob and restore cooking without losing any adjustments.

- Make Sure the cooking zone is running.
- Press the Stop & Go  button. The Cooking zone indicators will show “//”. The hob Will Be deactivated, except for the Stop & Go , ON/OFF and Safe .
- To Cancel the pause, press the Stop & Go  button. The Cooking Zones will return to the power level you previously set.

## Using Cooking Functions (For IH60BF / IH90BFN1)

You can choose 3 handy cooking functions by pressing the cooking functions  key each time moves from one function to the other.

-  - Melt or defrost (about 50 °C)
-  - Heating or keeping warm (about 70 °C)
-  - Simmering, temperature close to boiling, useful for slow cooking

## Over-Temperature Protection

A temperature sensor equipped can monitor the temperature inside the induction cooktop. When an excessive temperature is monitored, the induction cooktop will stop operation automatically.

## Residual Heat Warning

When the cooktop has been operating for some time, there will be some residual heat. The letter “H” appears to warn you to keep away from it.

## Detection Of Small Articles For Induction Cooktop

When an unsuitable size or non-magnetic pan (e.g. aluminium), or some other small item (e.g. knife, fork, key) has been left on the cooktop, the cooktop automatically go to standby in 1 minute. The fan will keep cooking down the induction cooktop for a further 1 minute.

## Auto Shutdown

Another safety feature of the cooktop is auto shutdown. This occurs whenever you forget to switch off a cooking zone. The default shutdown times are shown in the table below:

IH30BF:

Power level	1	2	3	4	5	6	7	8	9
Default working timer(hour)	4	4	4	3	3	3	2	2	1.5

IH60BF / IH90BFN1:

Power level	1	2	3	4	5	6	7	8	9
Default working timer(hour)	6	6	6	3	3	3	2	2	1.5



People with a heart pace maker should consult with their doctor before using this unit.

## Using The Timer

You can use the timer in two different ways:

- You can use it as a minute minder. In this case, the timer will not turn any cooking zone off when the set time is up.
- You can set it to turn one cooking zone off after the set time is up.
- You can set the timer up to 99 minutes.



## Using The Timer As A Minute Minder

If you are not selecting any cooking zone

1. Make sure the cooktop is turned on.

NOTE: you can use the minute minder even if you're not selecting any cooking zone.

2. Touch timer control, the minder indicator will start flashing and "30" will show in the timer display.



3. Adjust the timer setting by touch the "-" or "+" controls.

The minute minder indicator will start flashing and will show in the timer display.

Hint: Touch the "-" or "+" control of the timer once to decrease or increase by 1 minute. Touch and hold the "-" or "+" control of the timer to decrease or increase by 10 minutes. If the setting time exceeds 99 minutes, the timer will automatically return to 0 minute.

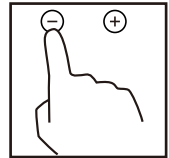

4. To cancel the timer, touch the timer control, and the "--" will show in the minute display.

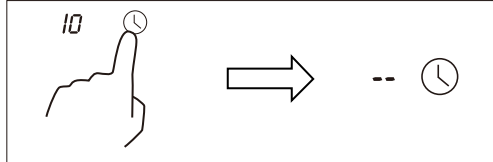

5. When the time is set, it will begin to count down immediately. The display will show the remaining time and the timer indicator will flash for 5 seconds.



6. Buzzer will beep for 30 seconds and the timer indicator shows "--" when the setting time finished.

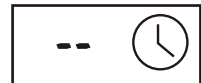

NOTE: The cooktop will continue to cook, this timer function is a minute minder only, it does not turn the cooktop off.

## Setting The Timer To Turn One Cooking Zone Off

1. Touching the heating zone selection control that you want to set the timer for.

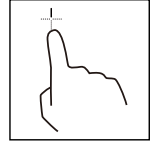

2. Touch timer control, the minder indicator will start flashing and "30" will show in the timer display.



3. Set the time by touching the or control of the tim .  
 Hint: Touch the "-" or "+" control of the timer once will decrease or increase by 1 minute. Touch and hold the "-" or "+" control of the timer will decrease or increase by 10 minutes. If the setting time exceeds 99 minutes, the timer will automatically return to 0 minute.

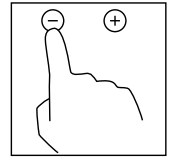

4. To cancel the timer, touch the heating zone selection control, and then touch the timer control. The minute display will show "--".

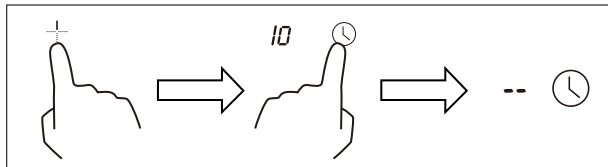

5. When the time is set, it will begin to count down immediate. The display will show the remaining time and the timer indicator flash for 5 seconds.



NOTE: The red dot next to power level indicator will illuminate indicating that zone is selected.



6. When cooking timer expires, the corresponding cooki zone will be switch off automatically.

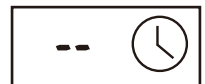



⚠ Other cooking zone will keep operating if they are turned on previously.

## Setting The Timer To Turn More Than One Cooking Zone Off

1. If more than one heating zone use this function, the timer indicator will show the lowest time. (e.g. zone 2# setting time of 3 minutes, zone 3# setting time of 6 minutes, the timer indicator shows “3”.)

NOTE: The red dot next to power level indicator will flash.

6.  (set to 6 minutes)

 3  (set to 3 minutes)



2. When cooking timer expires, the corresponding cooking zone will be switch off automatically.



NOTE: If you want to change the time after the timer is set, you have to start from step 1.

## Cooking Guidelines



Take care when frying as the oil and fat heat up very quickly, particularly if you're using Power Boost. At extremely high temperature oil and fat will ignite spontaneously and this presents a serious fire risk.

## Cooking Guidelines

- When food comes to the boil, reduce the temperature setting.
- Using a lid will reduce cooking times and save energy by retaining the heat.
- Minimize the amount of liquid or fat to reduce cooking times.
- Start cooking on a high setting and reduce the setting when the food has heated through.

## Simmering, Cooking Rice

- Simmering occurs below boiling point, at around 85 °C (185 °F), when bubbles are just rising occasionally to the surface of the cooking liquid. It is the key to delicious soups and tender stews because the flavor develops without overcooking the food. You should also cook egg-based and flour-thickened sauces below boiling point.
- Some tasks, including cooking rice by the absorption method, may require a setting higher than the lowest setting to ensure the food is cooked properly in the time recommended.

## Searing steak

To cook juicy flavor some steaks:

1. Stand the meat at room temperature for about 20 minutes before cooking.
2. Heat up a heavy-based frying pan.
3. Brush both sides of the steak with oil. Drizzle a small amount of oil into the hot pan and then lower the meat onto the hot pan.
4. Turn the steak only once during cooking. The exact cooking time will depend on the thickness of the steak and your taste. Time may vary from 2 – 8 minutes per side. Press the steak to gauge how cooked it is the firmer it feels the more “well done” it will be.
5. Leave the steak to rest on a warm plate for a few minutes to allow it to relax and become tender before serving.

## For stir-frying

1. Choose a ceramic compatible flat-based wok or a large frying pan.
2. Have all the ingredients and equipment ready. Stir-frying should be quick. If cooking large quantities, cook the food in several smaller batches.
3. Preheat the pan briefly and add two tablespoons of oil.
4. Cook any meat first, put it aside and keep warm.
5. Stir-fry the vegetables. When they are hot but still crisp, turn the cooking zone to a lower setting, return the meat to the pan and add your sauce.

6. Stir the ingredients gently to make sure they are heated through.
7. Serve immediately.

## Heat Settings

The settings below are guidelines only. The exact setting will depend on several factors, including your cookware and the amount you are cooking. Experiment with the induction cooktop to find the settings that best suit you.

Heat setting	Suitability
1 - 2	<ul style="list-style-type: none"> <li>• Delicate warming for small amounts of food</li> <li>• Melting chocolate, butter, and foods that burn quickly</li> <li>• Gentle simmering</li> <li>• Slow warming</li> </ul>
3-4	<ul style="list-style-type: none"> <li>• Reheating</li> <li>• Rapid simmering</li> <li>• Cooking rice</li> </ul>
5-6	<ul style="list-style-type: none"> <li>• Pancakes</li> </ul>
7-8	<ul style="list-style-type: none"> <li>• Sauteing</li> <li>• Cooking pasta</li> </ul>
9	<ul style="list-style-type: none"> <li>• Stir-frying</li> <li>• Searing</li> <li>• Bringing soup to the boil</li> <li>• Boiling water</li> </ul>

## Care And Cleaning

What?	How?	Important!
<p>Everyday soiling on glass (fingerprints, marks, stains left by food or non-sugary spillovers on the glass)</p>	<ol style="list-style-type: none"> <li>1. Switch the power to the cooktop off.</li> <li>2. Apply a cooktop cleaner while the glass is still warm (but not hot!)</li> <li>3. Rinse and wipe dry with a clean cloth or paper towel.</li> <li>4. Switch the power to the cooktop back on.</li> </ol>	<ul style="list-style-type: none"> <li>• When the power of the cooktop is switched off, there will be no 'hot surface' indication but the cooking zone may still be hot! Take extreme care.</li> <li>• Heavy-duty scourers, some nylon scourers and harsh/abrasive cleaning agents may scratch the glass. Always read the label to check if your cleaner or scourer is suitable.</li> <li>• Never leave cleaning residue on the cooktop: the glass may become stained.</li> </ul>
<p>Boilovers, melts, and hot sugary spills on the glass</p>	<p>Remove these immediately with a fish slice, palette knife or razor blade scraper suitable for induction glass cooktops, but beware of hot cooking zone surfaces:</p> <ol style="list-style-type: none"> <li>1. Switch the power to the cooktop off at the wall.</li> <li>2. Hold the blade or utensil at a 30° angle and scrape the soiling or spill to a cool area of the cooktop.</li> <li>3. Clean the soiling or spill up with a dish cloth or paper towel.</li> <li>4. Follow steps 2 to 4 for "Everyday soiling on glass" above.</li> </ol>	<ul style="list-style-type: none"> <li>• Remove stains left by melts and sugary food or spillovers as soon as possible. If left to cool on the glass, they may be difficult to remove or even permanently damage the glass surface.</li> <li>• Cut hazard: when the safety cover is retracted, the blade in a scraper is razor-sharp. Use with extreme care and always store safely and out of reach of children.</li> </ul>
<p>Spillovers on the touch controls</p>	<ol style="list-style-type: none"> <li>1. Switch the power to the cooktop off.</li> <li>2. Soak up the spill</li> <li>3. Wipe the touch control area with a clean damp sponge or cloth.</li> <li>4. Wipe the area completely dry with a paper towel.</li> <li>5. Switch the power to the cooktop back on.</li> </ol>	<ul style="list-style-type: none"> <li>• The cooktop may beep and turn itself off, and the touch controls may not function while there is liquid on them. Make sure you wipe the touch control area dry before turning the cooktop back on.</li> </ul>

## Hints And Tips

Problem	Possible causes	What to do
The induction cooktop cannot be turned on.	No power.	Make sure the induction cooktop is connected to the power supply and that it is switched on. Check whether there is a power outage in your home or area. If you've checked everything and the problem persists, call a qualified technician.
The touch controls are unresponsive.	The controls are locked.	Unlock the controls. See section 'Using your induction cooktop' for instructions
The touch controls are difficult to operate.	There may be a slight film of water over the controls or you may be using the tip of your finger when touching the controls.	Make sure the touch control area is dry and use the ball of your finger when touching the controls.
The glass is being scratched.	Rough-edged cookware.	Use cookware with flat and smooth bases. See 'Choosing the right cookware'.
	Unsuitable, abrasive scourer or cleaning products being used.	See 'Care and cleaning'.
Some pans make crackling or clicking noises.	This may be caused by the construction of your cookware (layers of different metals vibrating differently).	This is normal for cookware and does not indicate a fault.
The induction cooktop makes a low humming noise when used on a high heat setting.	This is caused by the technology of induction cooking.	This is normal, but the noise should quieten down or disappear completely when you decrease the heat setting
Fan noise coming from the induction cooktop.	A cooling fan built into your induction cooktop has come on to prevent the electronics from overheating. It may continue to run even after you've turned the induction cooktop off.	This is normal and needs no action. Do not switch the power to the induction cooktop off at the wall while the fan is running

Problem	Possible causes	What to do
Pans do not become hot and appears in the display	The induction cooktop cannot detect the pan because it is not suitable for induction cooking	Use cookware suitable for induction cooking. See section 'Choosing the right cookware'.
	The induction cooktop cannot detect the pan because it is too small for the cooking zone or not properly centred on it.	Centre the pan and make sure that its base matches the size of the cooking zone.
The induction cooktop or a cooking zone has turned itself off unexpectedly, a tone sounds and an error code is displayed (typically alternating with one or two digits in the cooking timer display)	Technical fault.	Please note down the error letters and numbers, switch the power to the induction cooktop off at the wall, and contact a qualified technician



## Failure Display And Inspection

If an abnormality comes up, the induction cooktop will enter the protective state automatically and display corresponding protective codes:

Problem	Possible causes	What to do
	No pot or pot not suitable	Replace the pot.
ER03	Water or pot on the glass over the control	Clean the user interface.
F1 E	The connection between the display board and the mainboard is fail (the cooking zone which indicator showing "E")	Please contact the supplier.
F3 E	Coil temperature sensor failure. (the cooking zone which indicator showing "E")	
F4 E	Mainboard temperature sensor failure. (the cooking zone which indicator showing "E")	
E1 E	Temperature sensor of the ceramic glass plate is high	Please restart after the induction hob cools down.
E2 E	Temperature sensor of the IGBT is high	
E3 E	Abnormal supply voltage (too high)	Check whether the power/voltage output is stable.
E4 E	Abnormal supply voltage (too low)	
E5 E	Temperature sensor failure (the cooking zone which indicator showing "E")	Connection cable not correctly plugged or assemble defective.

The above are the judgment and inspection of common failures. Please do not disassemble the unit by yourself to avoid any dangers and damages to the induction cooktop.

Model	IH30BF	IH60BF	IH90BFN1
Cooking Zones	2 Zones	4 Zones	5 Zones
Supply Voltage	220~240V~	220~240V~	220~240V~
Frequency	50/60HZ	50/60Hz	50/60Hz
Total Power	3500W	7200W	9500W
Product Size	11 1/2"x20 1/2"x 2 2/5"	23 1/5"x20 1/2"x 2 2/5"	35 2/5"x20 1/2"x 2 2/5"
Built-in Dimension	10 2/5"x19 2/5"	22 1/4"x19 1/2"	34 2/5"x19 1/2"

Weight and Dimensions are approximate. Because we continually strive to improve our products we may change specifications and designs without prior notice.

## Installation Selection Of Installation Equipment

Cut out the work surface according to the sizes shown in the drawing. For the purpose of installation and use, a minimum of 2 inch space shall be preserved around the hole.

Be sure the thickness of the work surface is at least 1 1/8 inch . Please select heat-resistant work surface material to avoid larger deformation caused by the heat radiation from the hotplate. As shown below :

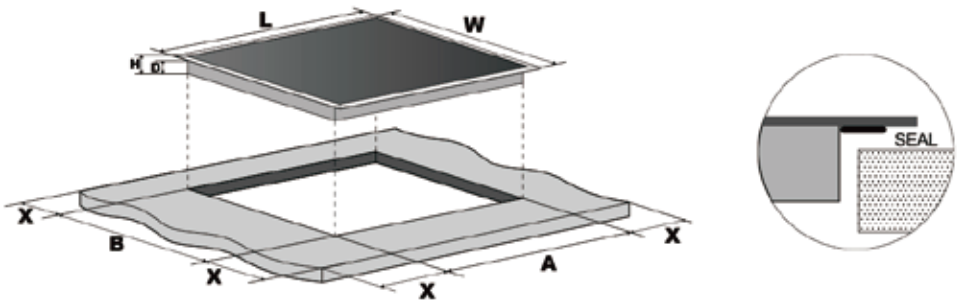

Model	L	W	H	D	A	B	X
IH30BF	11 1/2"	20 1/2"	2 2/5"	2 1/5"	10 2/5"	19 2/5"	2" mini
IH60BF	23 1/5"	20 1/2"	2 2/5"	2 1/5"	22 1/4"	19 1/2"	2" mini
IH90BFN1	35 2/5"	20 1/2"	2 2/5"	2 1/5"	34 1/4"	19 1/2"	2" mini

Under any circumstances, make sure the Induction cooktop is well ventilated and the air inlet and outlet are not blocked. Ensure the Induction cooktop is in good work state. As shown below.

 NOTE: The safety distance between the hotplate and the cupboard above the hotplate should be at least 30 inch.

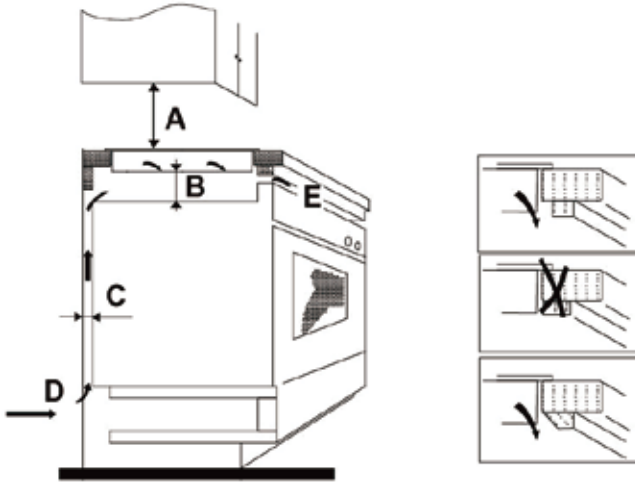

A	B	C	D	E
30"	2" mini	4/5" mini	Air intake	Air exit 1/5"

## Before You Install The Cooktop, Make Sure That

- The work surface is square and level, and no structural members interfere with space requirements.
- The work surface is made of a heat-resistant material.
- If the cooktop is installed above an oven, the oven has a built-in cooling fan
- The installation will comply with all clearance requirements and applicable standards and regulations.
- A suitable isolating switch providing full disconnection from the mains power supply is incorporated in the permanent wiring, mounted and positioned to comply with the local wiring rules and regulations. The isolating switch must be of an approved type and provide a 3 mm air gap contact separation in all poles (or in all active phase

conductors if the local wiring rules allow for this variation of the requirements).

- The isolating switch will be easily accessible to the customer with the cooktop installed.
- You consult local building authorities and by-laws if in doubt regarding installation.
- You use heat-resistant and easy-to-clean finishes (such as ceramic tiles) for the wall surfaces surrounding the cooktop.

## **When You Have Installed The Cooktop, Make Sure That**

- The power supply cable is not accessible through cupboard doors or drawers.
- There is adequate flow of fresh air from outside the cabinetry to the base of the cooktop.
- If the cooktop is installed above a drawer or cupboard space, a thermal protection barrier is installed below the base of the cooktop.
- The isolating switch is easily accessible by the customer

## **Before Locating The Fixing Brackets**

The unit should be placed on a stable, smooth surface (use the packaging). Do not apply force onto the controls protruding from the cooktop.

## **Adjusting The Bracket Position**

Fix the cooktop on the work surface by screw 4 brackets on the bottom of cooktop (see picture) after installation.

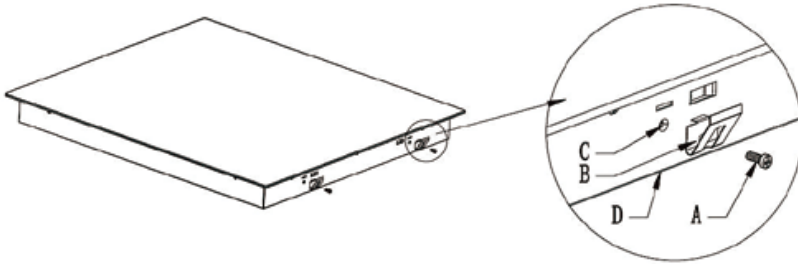

<b>A</b>	<b>B</b>	<b>C</b>	<b>D</b>
Screw	Bracket	Screw Hole	Bottom Base

Worktop/Kitchen cabinet

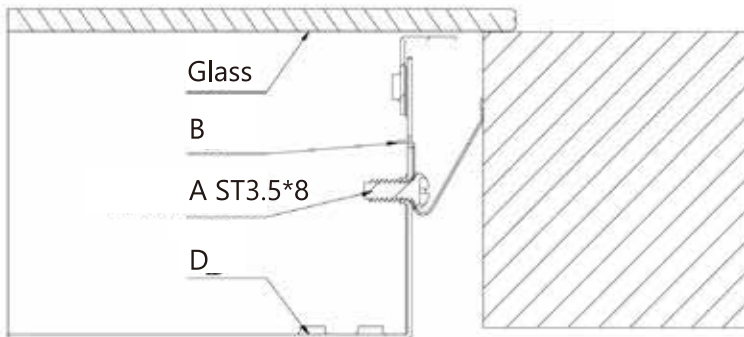

## Cautions

1. The induction cooktop must be installed by qualified personnel or technicians. We have professionals at your service. Please never conduct the operation by yourself.
2. The cooktop will not be installed directly above a dishwasher, fridge, freezer, washing machine or clothes dryer, as the humidity may damage the cooktop electronics.
3. The induction cooktop shall be installed such that better heat radiation can be ensured to enhance its reliability.

4. The wall and induced heating zone above the table surface shall withstand heat.
5. To avoid any damage, the sandwich layer and adhesive must be resistant to heat.

## Locating the fixing brackets

The unit should be placed on a stable, smooth surface (use the packaging). Do not apply force onto the controls protruding from the hob.

Fig 1

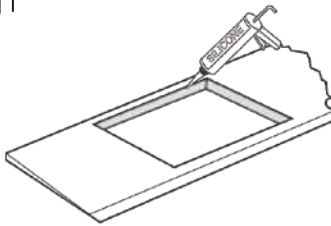

01



Cut out worktop to supplied dimensions shown (fig. 1) with suitable equipment. Seal the cut edge of the worktop using silicone or PTFE and allow to dry prior to fitting the hob.

Fig 2



02



Stretch out the supplied seal along the underside edge of the hob ensuring the ends overlap.

03

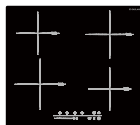

Fig 3

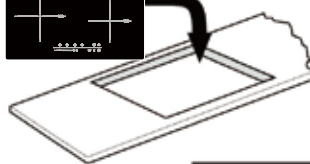

Fig 4

Do not use adhesive to fix the hob into the worktop. Once the seal is fitted position the hob into the cutout in the worktop. Apply gentle downwards pressure onto the hob to push it into the worktop ensuring a good seal around the outer edge (fig.4)

## Connecting The Cooktop To The Mains Power Supply

The power supply should be connected in compliance with the relevant standard, or a single-pole circuit breaker. The method of connection is shown below.

1. If the cable is damaged or needs replacing, this should be done by an after-sales technician using the proper tools, so as to avoid any accidents.
2. If the appliance is being connected directly to the mains supply, an omnipolar circuit breaker must be installed with a minimum gap of 0.118 in between the contacts.
3. The installer must ensure that the correct electrical connection has been made and that it complies with safety regulations.
4. The cable must not be bent or compressed.
5. The cable must be checked regularly and only replaced by a properly qualified person.

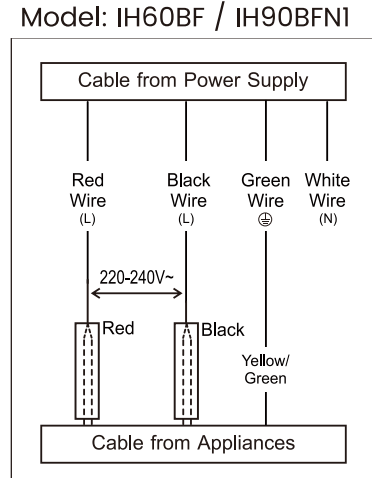
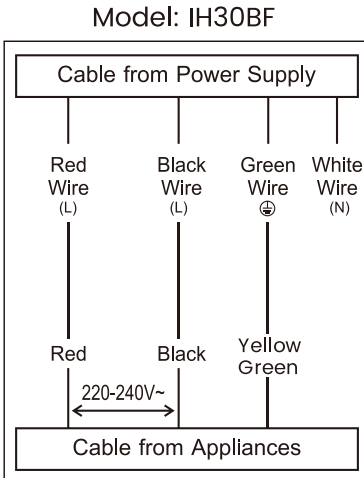



1 (844) 538-7890



[www.gaslandchef.com](http://www.gaslandchef.com)



[support@gaslandchef.com](mailto:support@gaslandchef.com)



8350 Patriot Blvd STE B,  
N. Charleston, SC 29418

