

# Ethnicraft

## ASSEMBLY INSTRUCTIONS FOR BED INSTALLATION

---

### SPINDLE BED - KING SIZE - WITH SLATS

CODE	DESCRIPTION
51248	OAK SPINDLE BED - US KING SIZE - WITH SLATS 193/203/97
45188	WALNUT SPINDLE BED - US KING SIZE - WITH SLATS 193/203/97

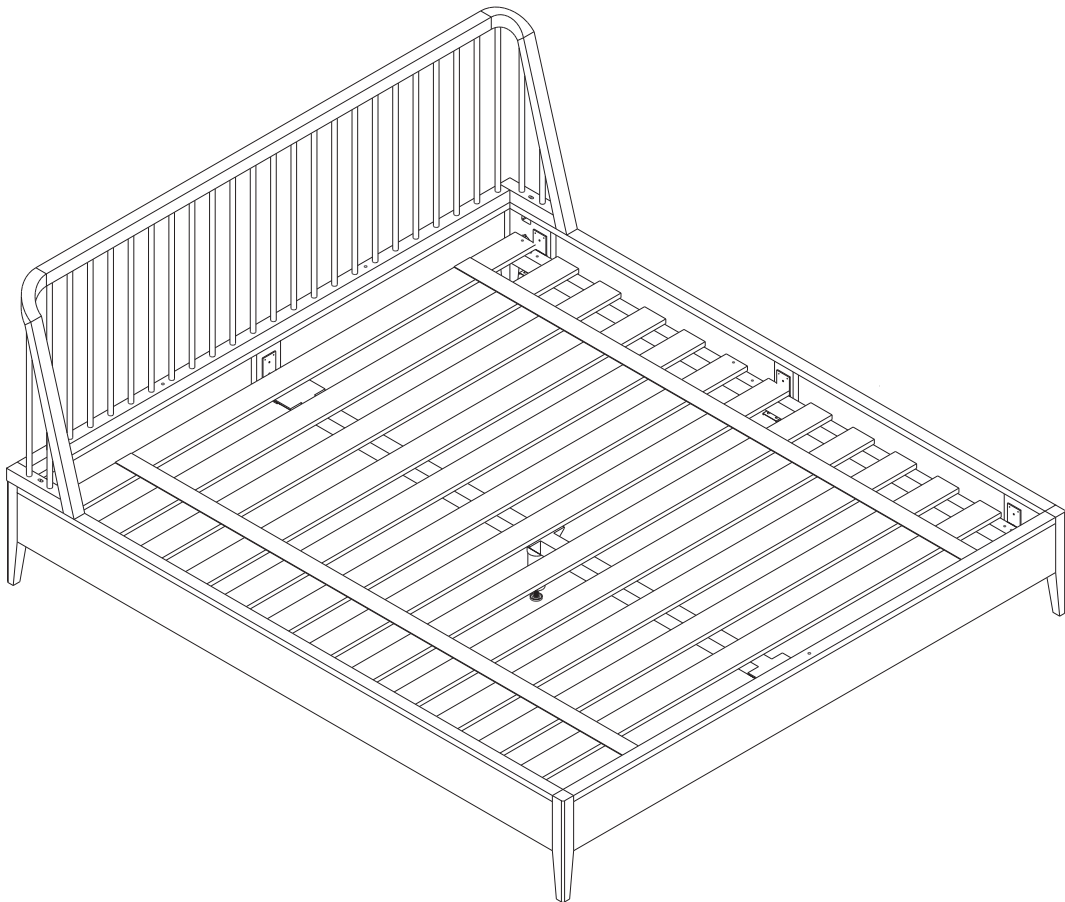

## SPINDLE BED - KING SIZE - WITH SLATS ASSEMBLY INSTRUCTIONS FOR BED INSTALLATION

### NOTE

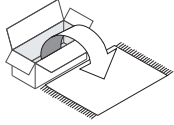

CAREFULLY OPEN THE CARTON, REMOVE CONTENTS AND LAY OUT ON CARPET OR THE PACKAGING CARTON BOX OR OTHER PROTECTIVE SURFACE TO AVOID DAMAGE.

CHECK PACKAGE CONTENTS TO ASSURE ALL THE NECESSARY HARDWARE AND PARTS ARE RECEIVED UNDAMAGE. DO NOT USE DAMAGED OR DEFECTIVE PARTS/ HARDWARE. CONTACT ETHNICRAFT FOR ANY MISSING PART AND OR HARDWARE.



READ THE ASSEMBLY INSTRUCTION BEFORE INSTALLATION AND CAREFULLY FOLLOW THE INSTRUCTION GIVEN. SEEK THE ADVICE OF A PROFESSIONAL IF YOU ARE NOT FAMILIAR WITH THESE INSTALLATION OR HAVE ANY DOUBTS ABOUT THE SAFETY OF THIS INSTALLATION.

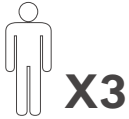

IT IS ADVISABLE TO DO THIS ASSEMBLY WITH MINIMUM OF 3 PERSONS.

### PARTS TO ASSEMBLE

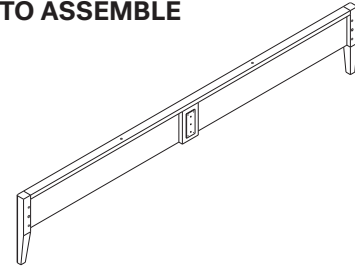

**(A) HEADBOARD 1piece**

CODE	DESCRIPTION
P4542	OAK HEADBOARD FOR US KING BED
P7118	WALNUT HEADBOARD FOR US KING BED

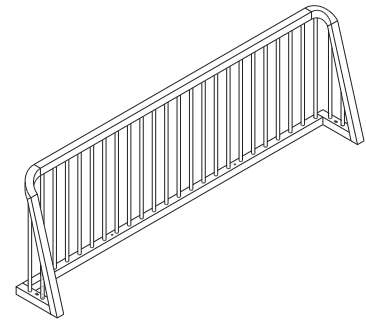

**(B) BED HEAD 1piece**

CODE	DESCRIPTION
P4544	OAK BED HEAD FOR US KING BED
P7120	WALNUT BED HEAD FOR US KING BED



**(F) CENTER LEG 1piece**

CODE	DESCRIPTION
H1261	CENTER LEG FOR US BED

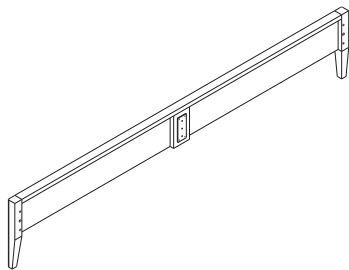

**(C) FOOTBOARD 1piece**

CODE	DESCRIPTION
P4537	OAK FOOTBOARD FOR US KING BED
P7119	WALNUT FOOTBOARD FOR US KING BED

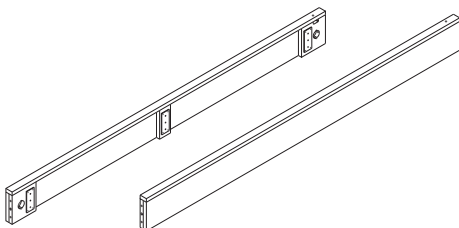

**(D) SIDERAIL 1set (left & right)**

CODE	DESCRIPTION
P4539	OAK SIDERAIL FOR US KING BED
P7114	WALNUT SIDERAIL FOR US KING BED

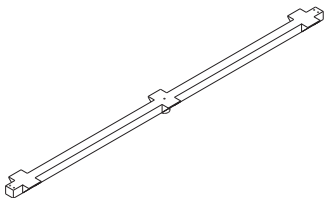

**(E) CENTER SUPPORT 1piece**

CODE	DESCRIPTION
H1166	CENTER LEG FOR US KING BED

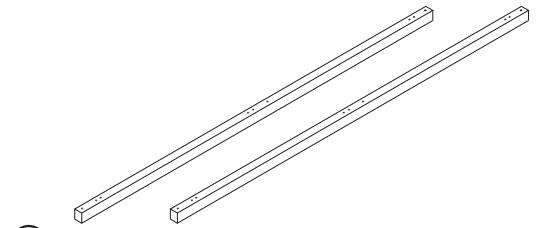

**(G) SLATS SUPPORTS 1set (left & right)**

CODE	DESCRIPTION
P4584	SLATS SUPPORT FOR US KING BED

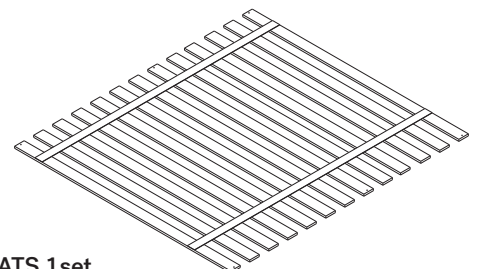







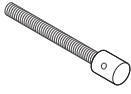
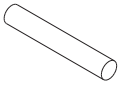
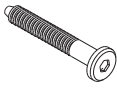

**(H) SLATS 1set**

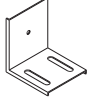
CODE	DESCRIPTION
P0853	TEAK FJ SLATS FOR US KING BED

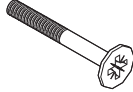
**SPINDLE BED - KING SIZE - WITH SLATS**  
**ASSEMBLY INSTRUCTIONS FOR BED INSTALLATION**

**HARDWARE ENCLOSED**

 <b>H0667</b> <b>HALFMOON WASHER</b> (4pcs)	 <b>H0666</b> <b>HALFMOON BOLT</b> <b>M8x100</b> (4pcs)	 <b>H0308</b> <b>DOWEL</b> <b>Ø12x50 mm</b> (8pcs)	 <b>H0742</b> <b>JCBC SCREW</b> <b>M6x70</b> (4pcs)	 <b>H0228</b> <b>LONG NUT</b> <b>M6</b> (2pcs)
 <b>H0951</b> <b>L BRACKET</b> (8pcs)	 <b>H0949</b> <b>JCBC SCREW</b> <b>M6x6</b> (8pcs)	 <b>H0757</b> <b>JF SCREW</b> <b>M6x50</b> (5pcs)	 <b>H0747</b> <b>JF SCREW</b> <b>M6x80</b> (18pcs)	
 <b>H0987</b> <b>SPRING WASHER</b> <b>M6</b> (2pcs)	 <b>H0307</b> <b>WASHER</b> <b>M6x18</b> (2pcs)	 <b>H0744</b> <b>WASHER</b> <b>M6</b> (22pcs)	 <b>H0746</b> <b>NUT</b> <b>M6</b> (22pcs)	

**TOOLS**

(Included in packaged)

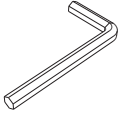
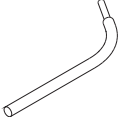
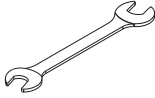
 <b>H0865</b> <b>L KEY</b>	 <b>H0741</b> <b>L KEY</b>	 <b>H0875</b> <b>WRENCH</b>
---	---	--

**TOOLS**

(Not included in packaged)

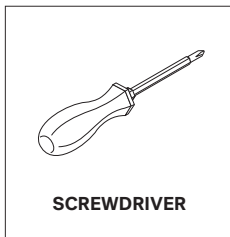

**SYMBOLS**



DIRECTION

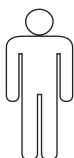

NUMBER OF  
PERSONS NEEDED

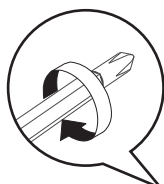

USE SCREWDRIVER  
TO TIGHTEN



USE WRENCH  
TO TIGHTEN



USE L KEY  
TO TIGHTEN



USE HAND



USE BOLT KEY  
TO TIGHTEN

## SPINDLE BED - KING SIZE - WITH SLATS ASSEMBLY INSTRUCTIONS FOR BED INSTALLATION

### A. CONNECTING SIDERAIL AND HEAD / FOOTBOARD

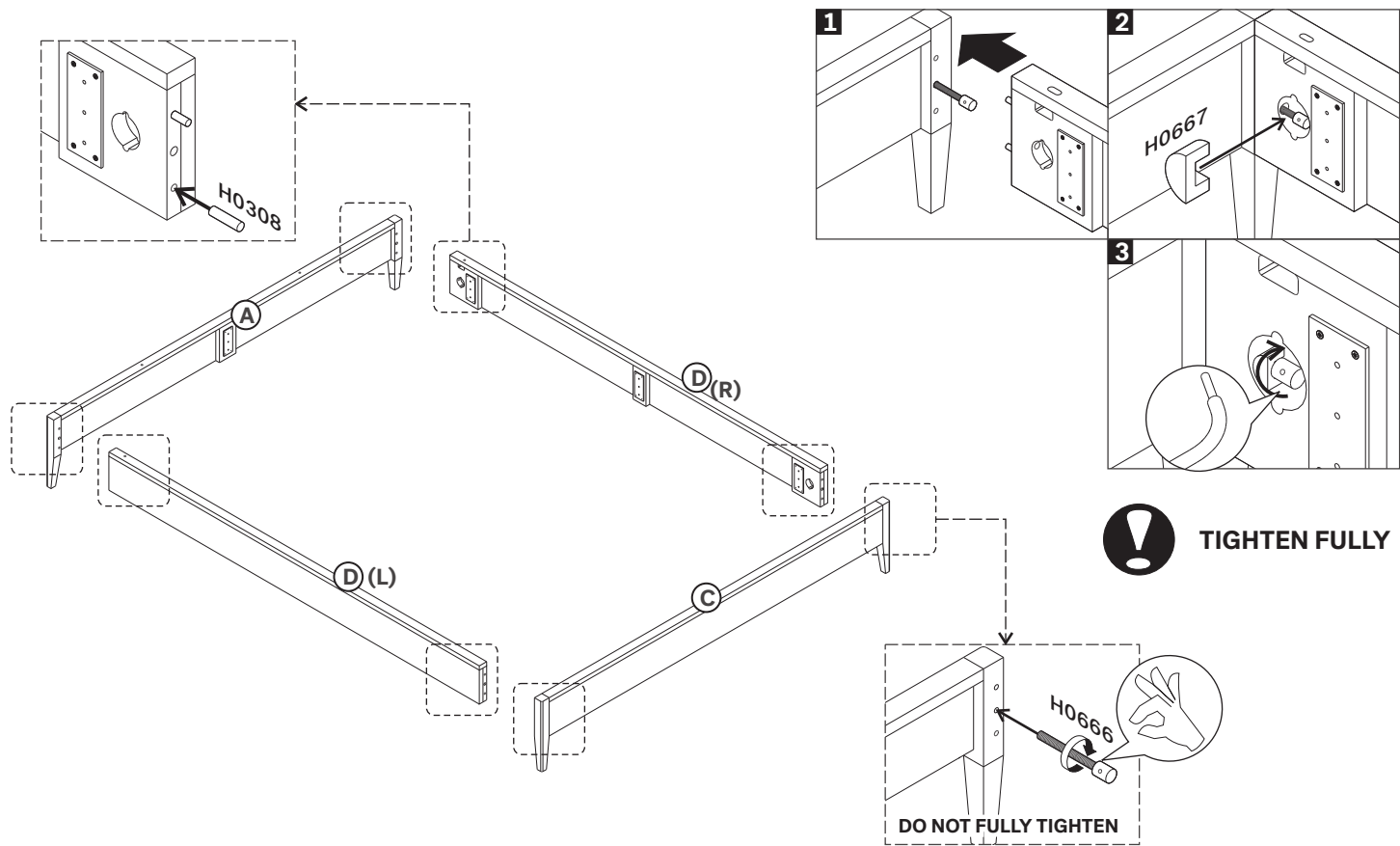

### B. CONNECTING CENTER LEG TO CENTER SUPPORT

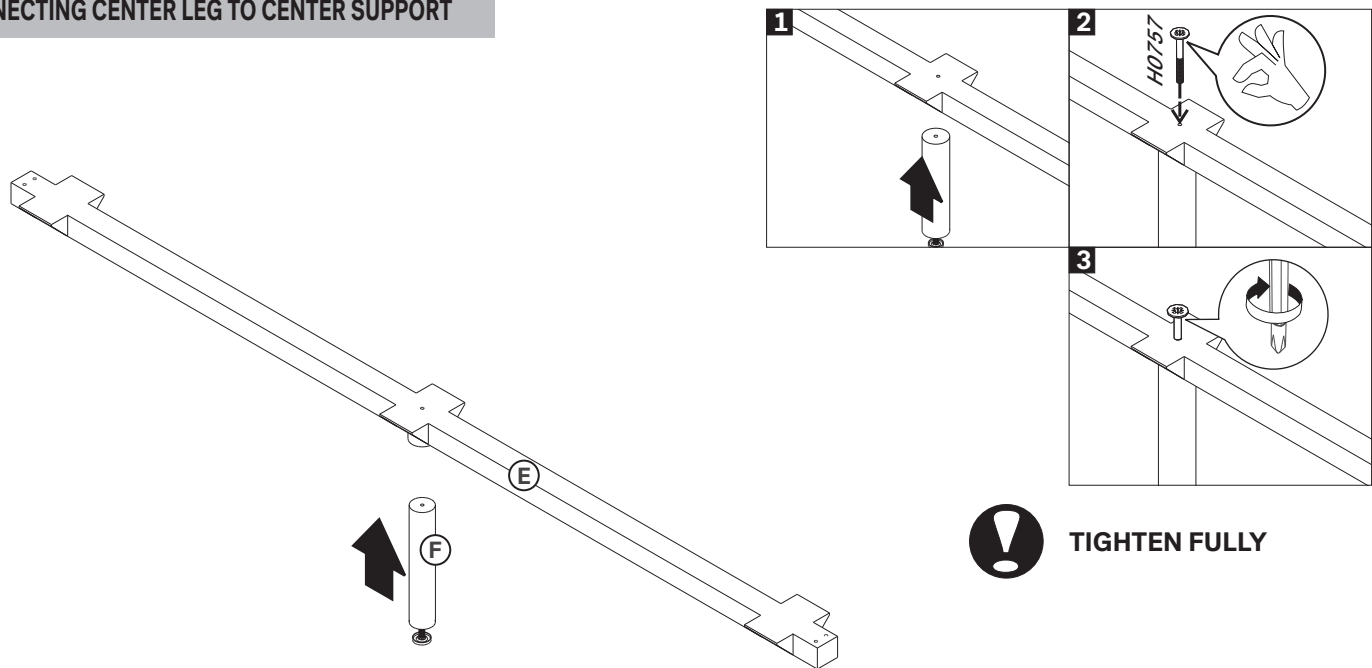

SPINDLE BED - KING SIZE - WITH SLATS  
 ASSEMBLY INSTRUCTIONS FOR BED INSTALLATION

**C. INSTALLING CENTER SUPPORT**

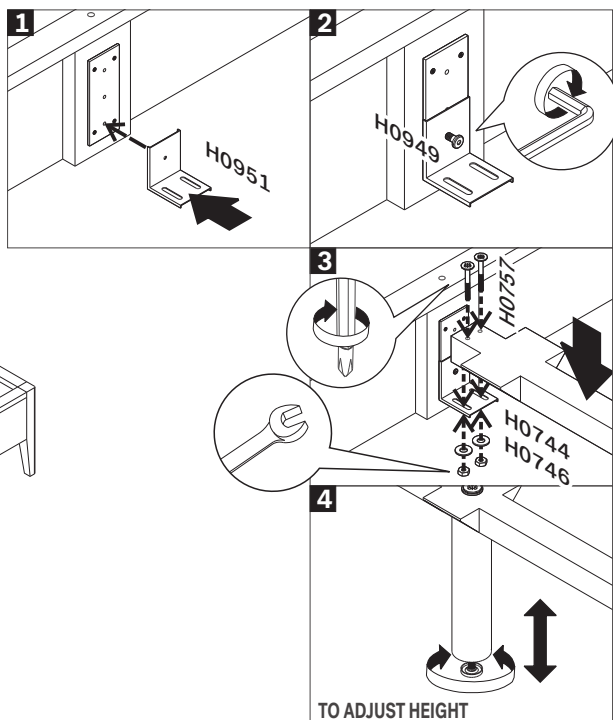
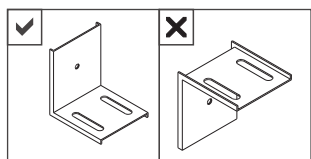
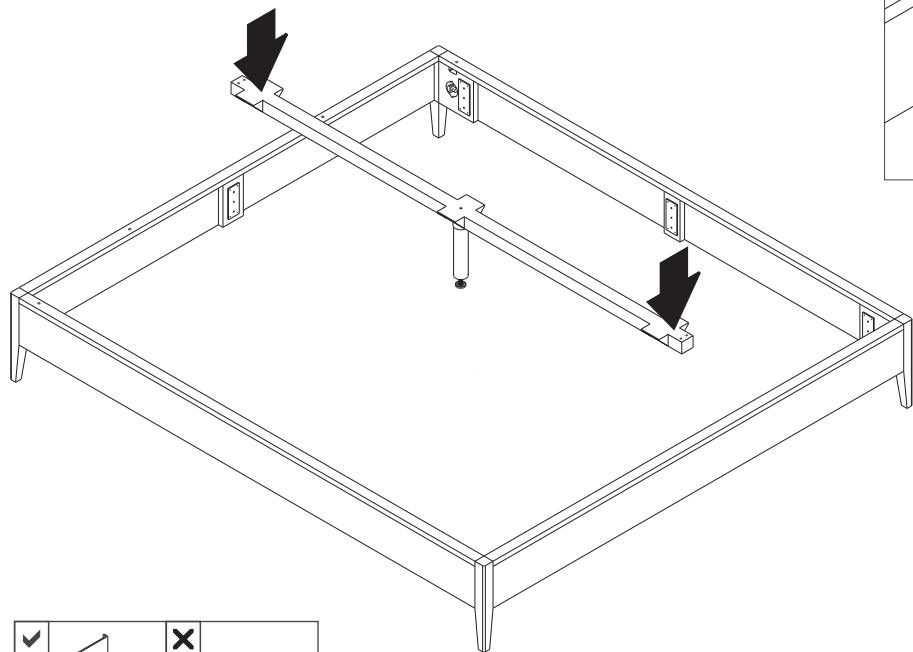

**! TIGHTEN FULLY ALL SCREWS**

**D. INSTALLING SLAT SUPPORTS**

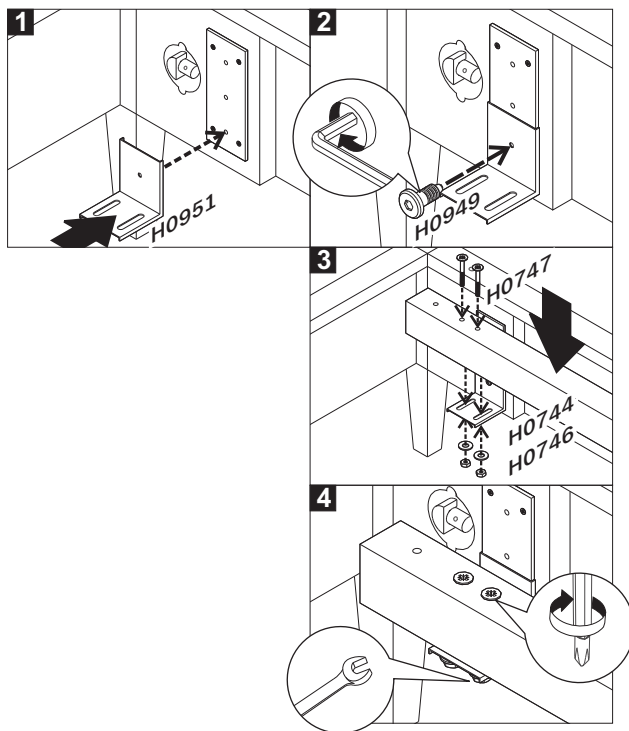
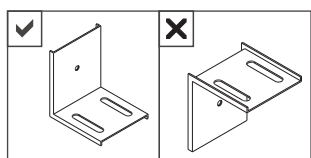
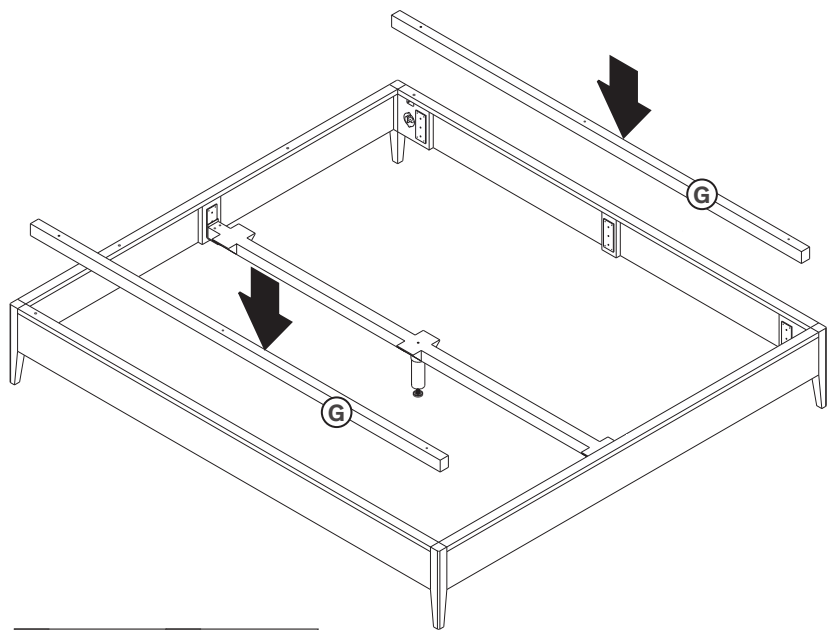

**! - TIGHTEN FULLY ALL SCREWS  
 - INSTALLING SLAT SUPPORTS AT THE SAME  
 LEVEL WITH CENTER SUPPORT**

## SPINDLE BED - KING SIZE - WITH SLATS ASSEMBLY INSTRUCTIONS FOR BED INSTALLATION

### E. INSTALLING HEADBOARD PANEL

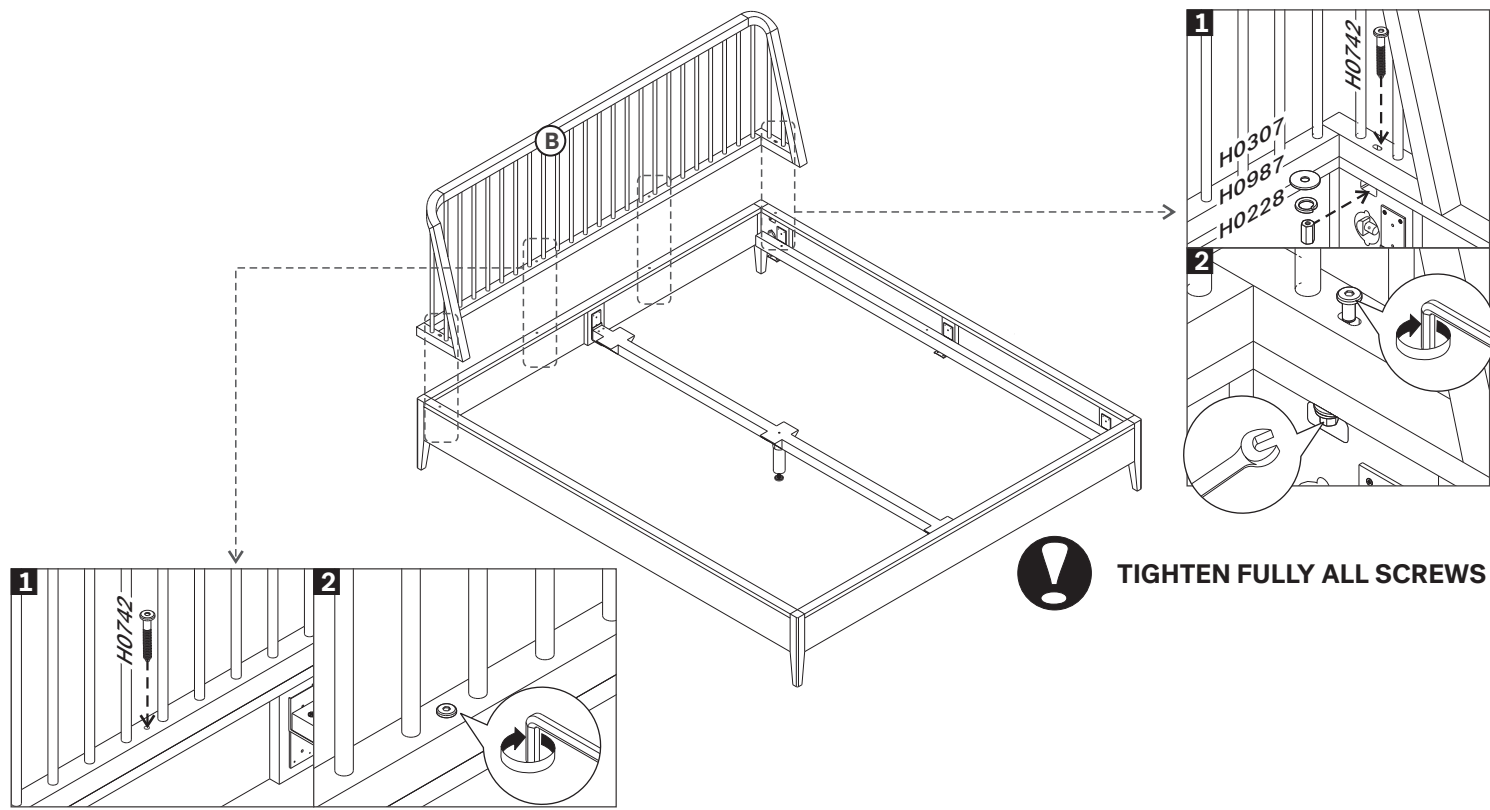

**TIGHTEN FULLY ALL SCREWS**

### F. INSTALLING SLATS

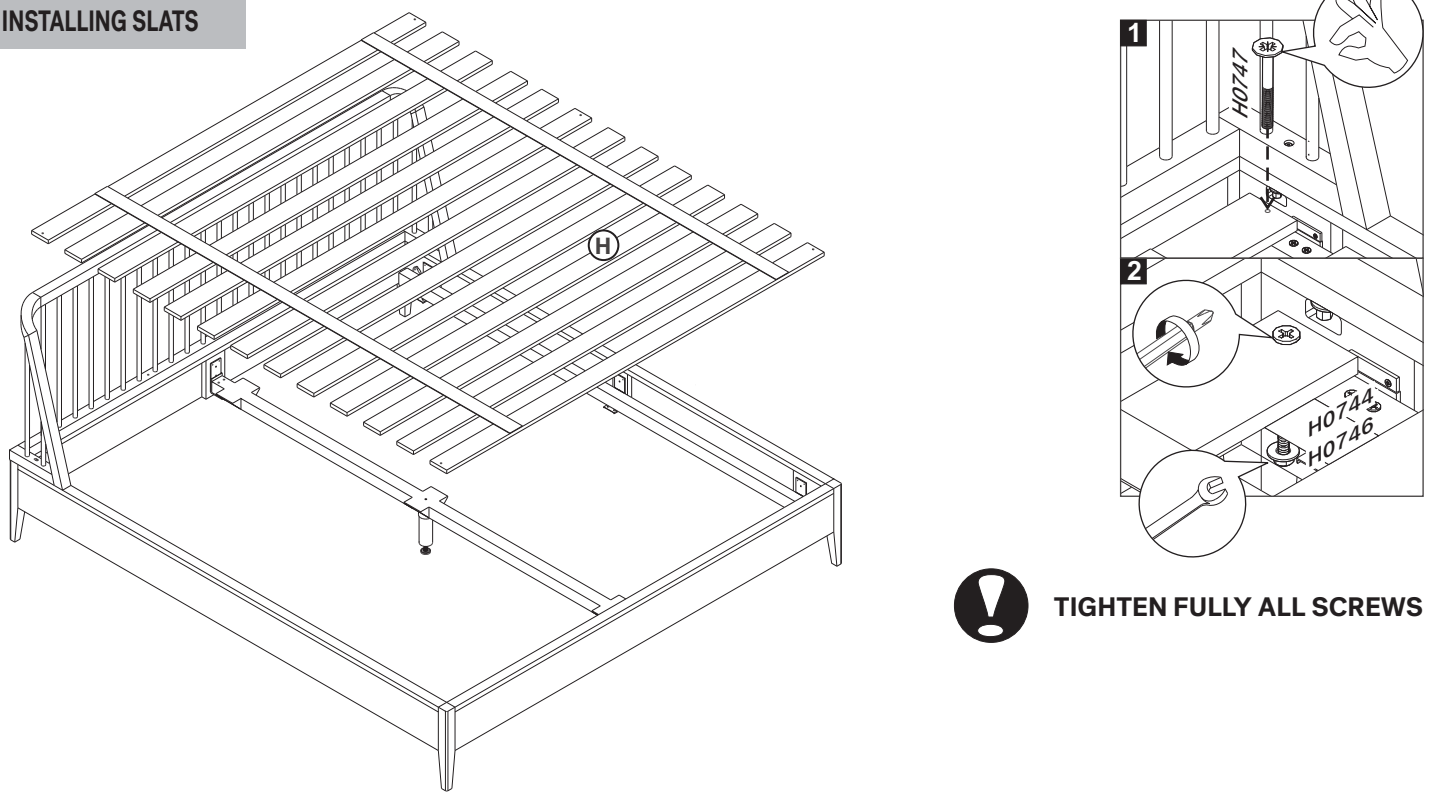

**TIGHTEN FULLY ALL SCREWS**

**SLATS TO BE ASSEMBLED ARE NUMBER 1, 6, AND 13**