

Tiramisu Coffee Table - Small

ASSEMBLY INSTRUCTION:

Thank you for purchasing the Coffee Table Small. This page lists all the contents included in the box. Please take time to identify the hardware as well as the individual components of this product. As you unpack and prepare for assembly, place the contents on a carpeted or padded area to protect them from damage.

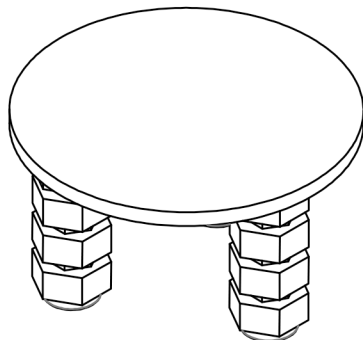

ASSEMBLY REQUIREMENTS:

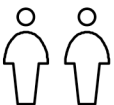

Do Not Use Power Tools

PARTS:

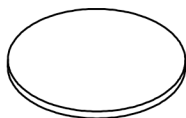

01 TABLE TOP & CONNECTING PLATE =1PC

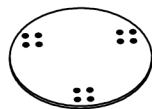

02 CONNECTING PLATE =1PC



03 BASE A =3PCS



04 BASE B =6PCS



05 BASE C =3PCS



06 HARDWARE =9PCS



07 SCREW =3PCS

HARDWARE:



(A) ALLAN WRENCH =1PC



(B) MACHINE SCREW =12PCS
(M6 16mm)



(C) WASHER =12PCS



(D) NUT =6PCS
(M20)



(E) WASHER =6PCS
(M20)



Tiramisu Coffee Table - Small

1

As shown in the figure, place the base A on the foam plate for installation.

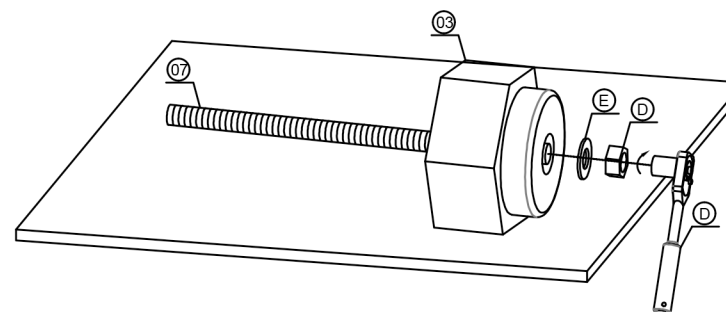

2

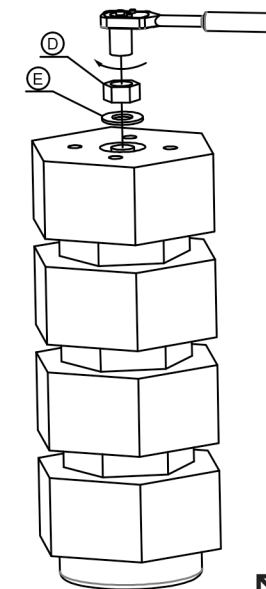
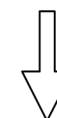
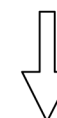
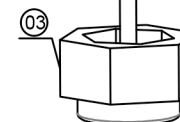
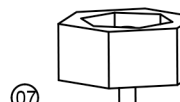
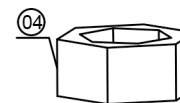
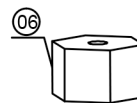

Coffee Table Small

3

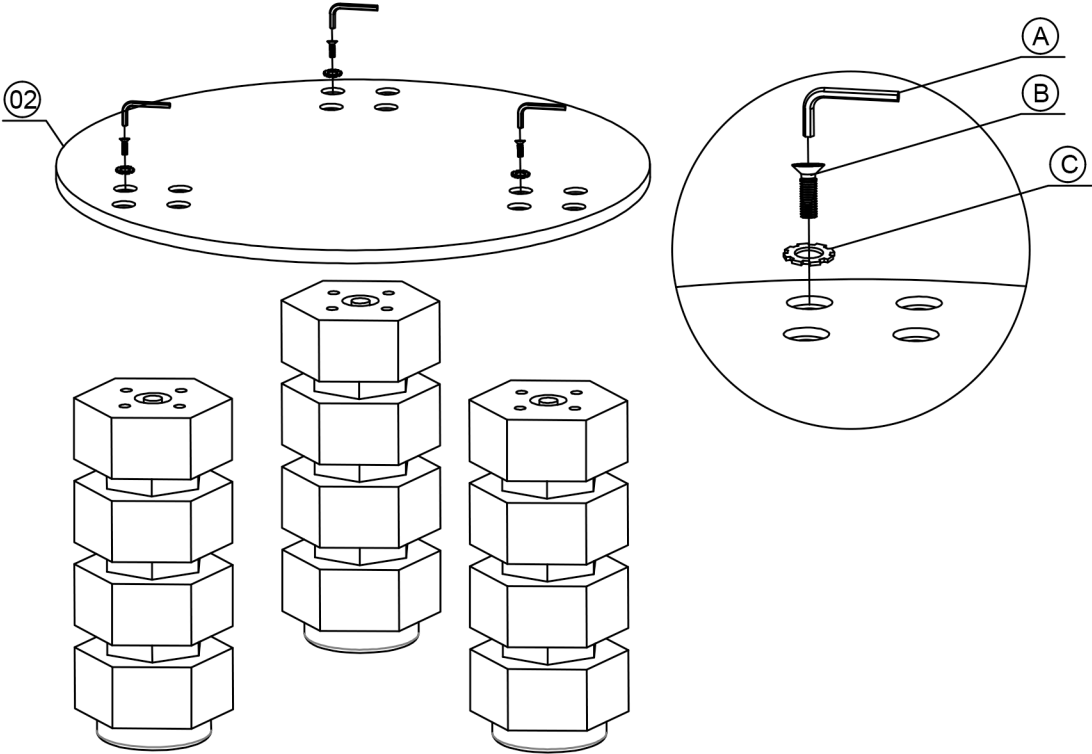

4

