

Sketch

SEQUEL MODULAR SOFA



sequel 43+52 : alpaca neige



sequel 220 : yuna pebbledash

10028-25 : Sequel 190

W1900 D900 H700

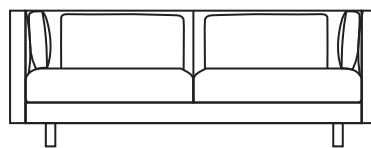

10028-30 : Sequel 220

W2200 D900 H700

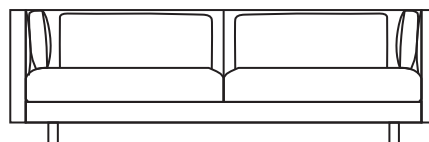

SEQUEL MODULAR SOFA

The intention in creating the Sequel sofa was to offer a program with multiple modular options, on a modest scale suited to smaller living spaces, with an aesthetic that is simple but not bland; timeless, and not hostage to trends. Additionally, fully removable covers were specified for greater utility, which also increases the life-span of the product.

Boxes ticked!

MATERIAL : Solid pine frame, steel Nozag springs, high density foam, feather & ball-fiber filling

DESIGN : Cameron Foggo

10028-41/42

: Sequel 1-arm 130LHF/RHF

W1300 D900 H700

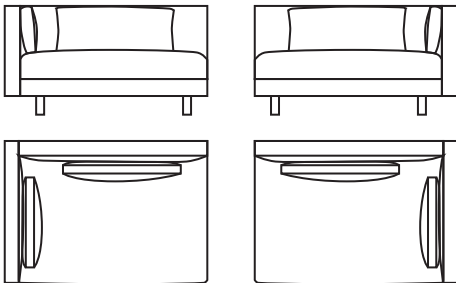

10028-43/44

: Sequel 1-arm 150LHF/RHF

W1500 D900 H700

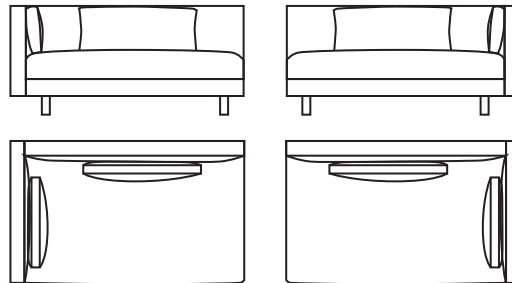

10028-491

: Sequel corner 90

W900 D900 H700

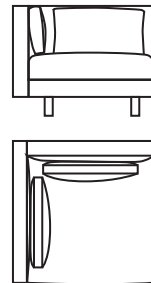

10028-51/52

: Sequel chaise 130LHF/RHF

W1300 D1300 H700

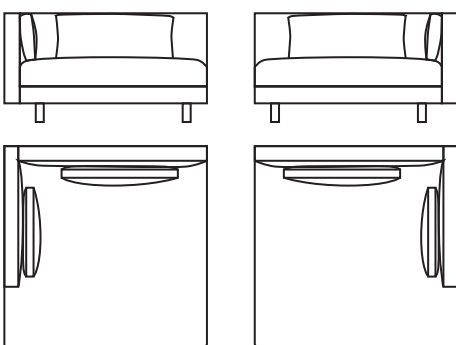

10028-55/56

: Sequel open end 130 LHF/RHF

W1300 D900 H700

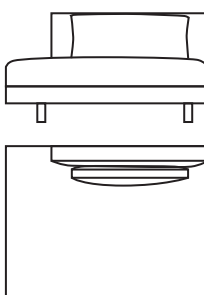

10028-492

: Sequel corner 130

W1300 D1300 H700

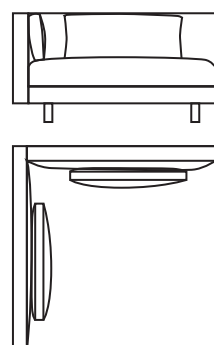



sequel 220 : yuna pebbledash



sequel 42+55 : montana desert



sequel 43+52 : alpaca neige