



Slab Coffee Table

Assembly Instructions

Hardware

1	 M6 x 30	12 pcs
2	 M6 X Ø18	08 pcs
3	 M6 X Ø30	04 pcs
4		01 pc

 x2 people required

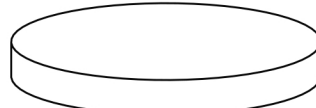

A x 1pc



B x 1pc

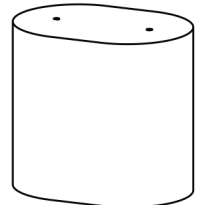

C x 4pcs

Step 1 Disassemble the top

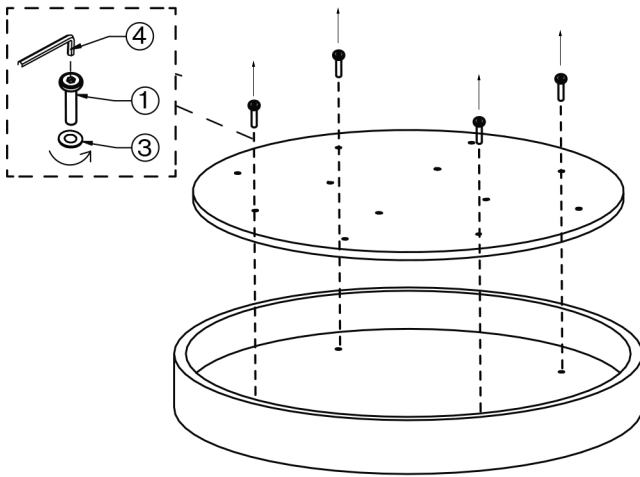

Step 2

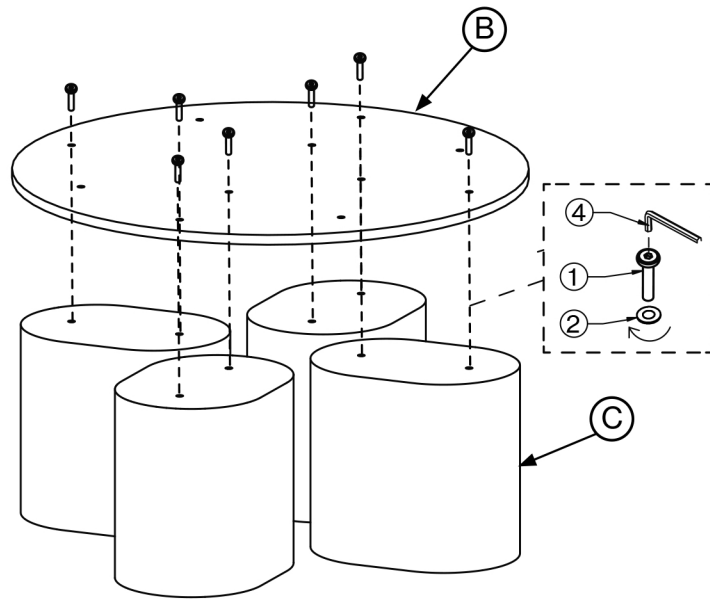

Step 3 Rest table top on base, no screws needed

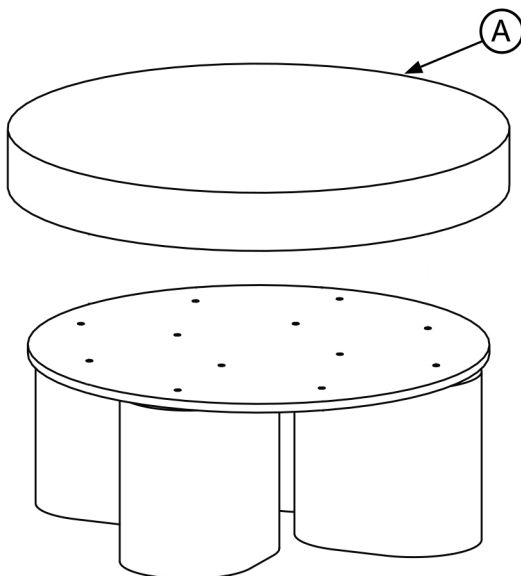

Finish

