

NATADORA

COCO DINING TABLE

by natadora design studio

Coco dining table is about honesty of materials and purity of form. Constructed entirely of solid American White Oak or Walnut and using only the most basic geometric forms, this focuses attention on the natural beauty of the wood. A slit down the center of the top is a clever woodworking device to allow expansion and contraction of the solid planks while also adding visual interest.



AVAILABLE IN THE FOLLOWING CONFIGURATIONS

coco table
2400L x 900D x 735H
2000L x 900D x 735H
1600L x 800D x 735H

made of solid american oak, solid american walnut,
solid american oak stained black

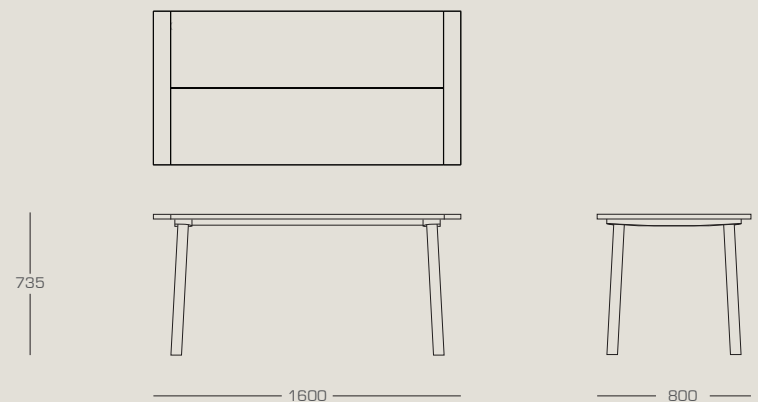
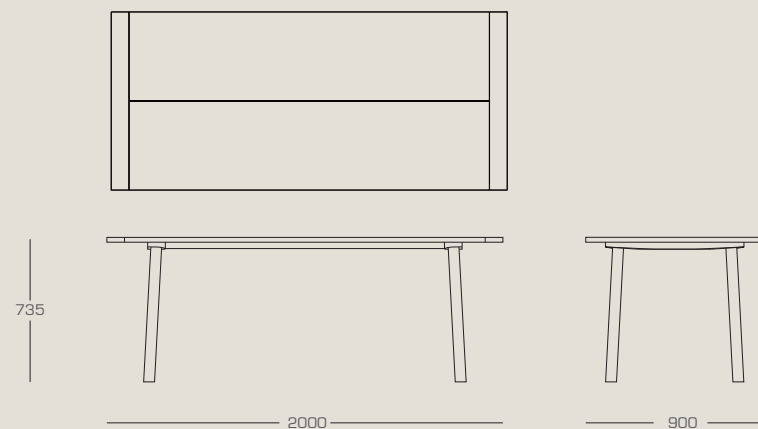
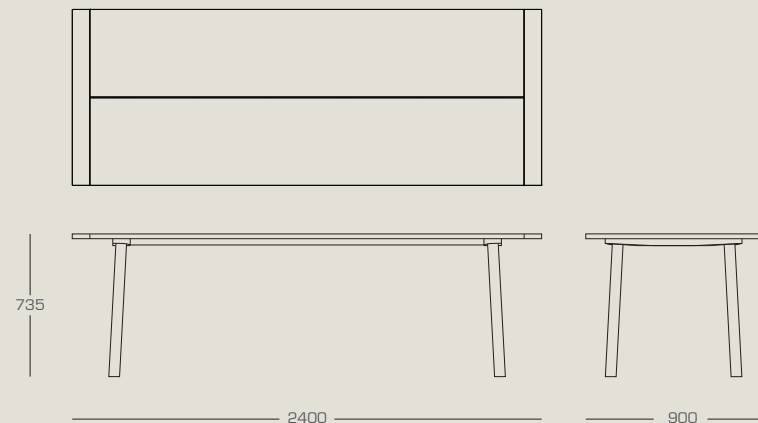

NATADORA

