

Merano Side Table

ITEM NO.:131961

Assembly Instructions:

Thank you for purchasing this SideTable.
This page lists all the contents included in the box.
Please take time to identify the hardware as well as the individual components of this product.
As you unpack and prepare for assembly, place the contents on a carpeted or padded area to protect them from damage.

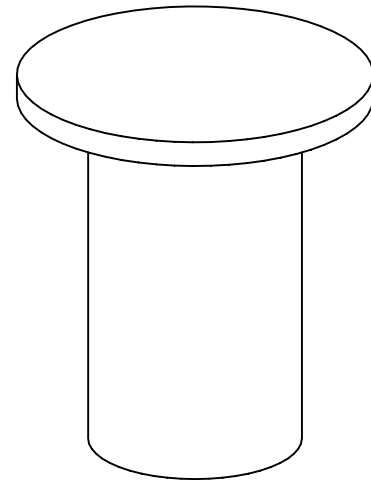

Assembly Requirements:

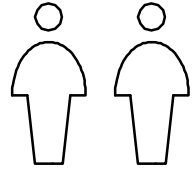

Parts:

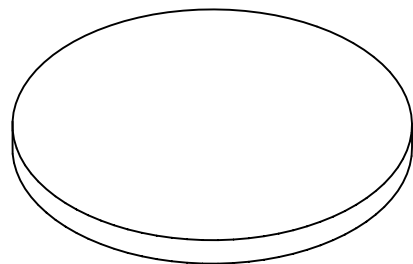

(A) TABLE TOP= 1PC

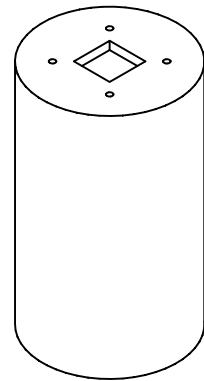

(C) TABLE BASE=1 PC

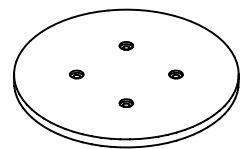

(B) CONNECTING BOARD= 1PC

Fittings:



(D) ALLEN KEY= 1PC

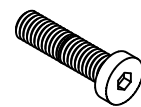

(E) MACHINE SCREW= 4PCS



(F) WASHER= 4PCS



Merano Side Table

Step 1

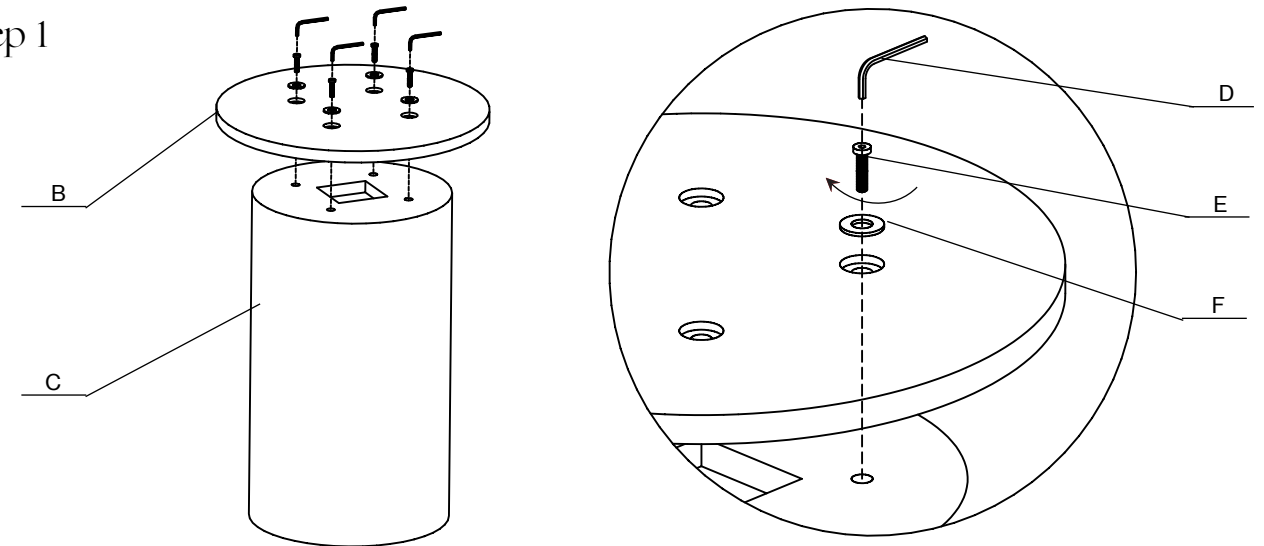

Step 2

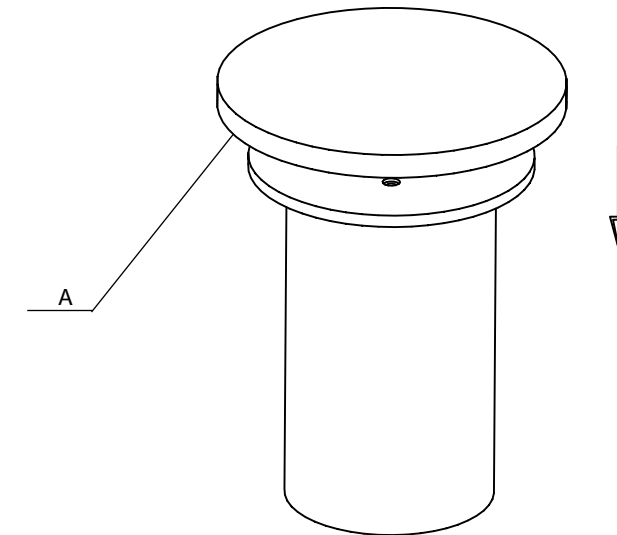

Finish

