

Heather Console Table

ITEM NO.:144438

Assembly Instructions:

Thank you for purchasing this Console Table.
 This page lists all the contents included in the box.
 Please take time to identify the hardware as well as
 the individual components of this product.
 As you unpack and prepare for assembly,
 place the contents on a carpeted or padded area
 to protect them from damage.

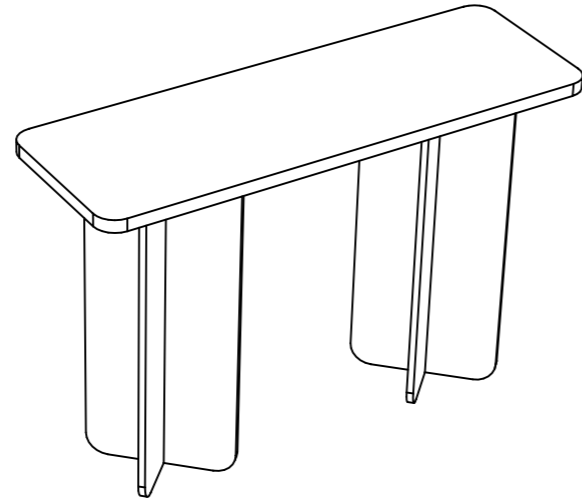

Assembly Requirements:

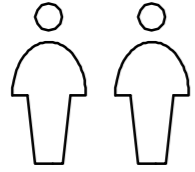

Parts:

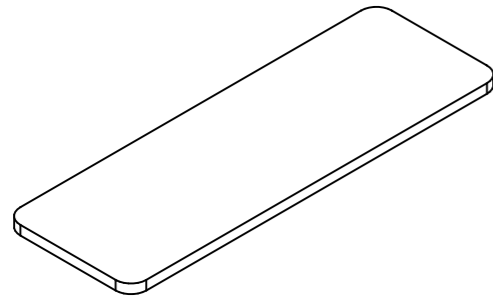

(A) TABLE TOP= 1PC

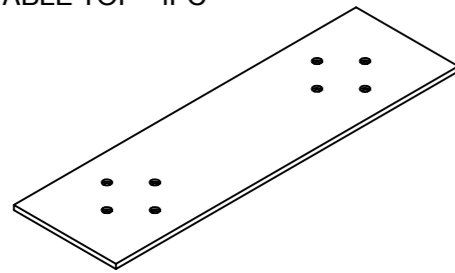

(B) CONNECTING BOARD= 1PC

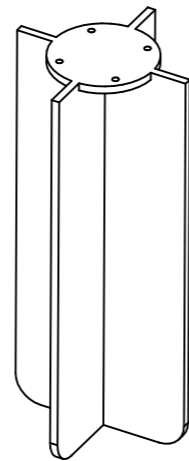

(C) TABLE BASE= 2 PCS

Fittings:



(D) ALLEN KEY= 1PC

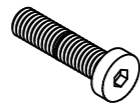

(E) MACHINE SCREW= 8 PCS



(F) WASHER= 8 PCS



Heather Console Table

Step 1

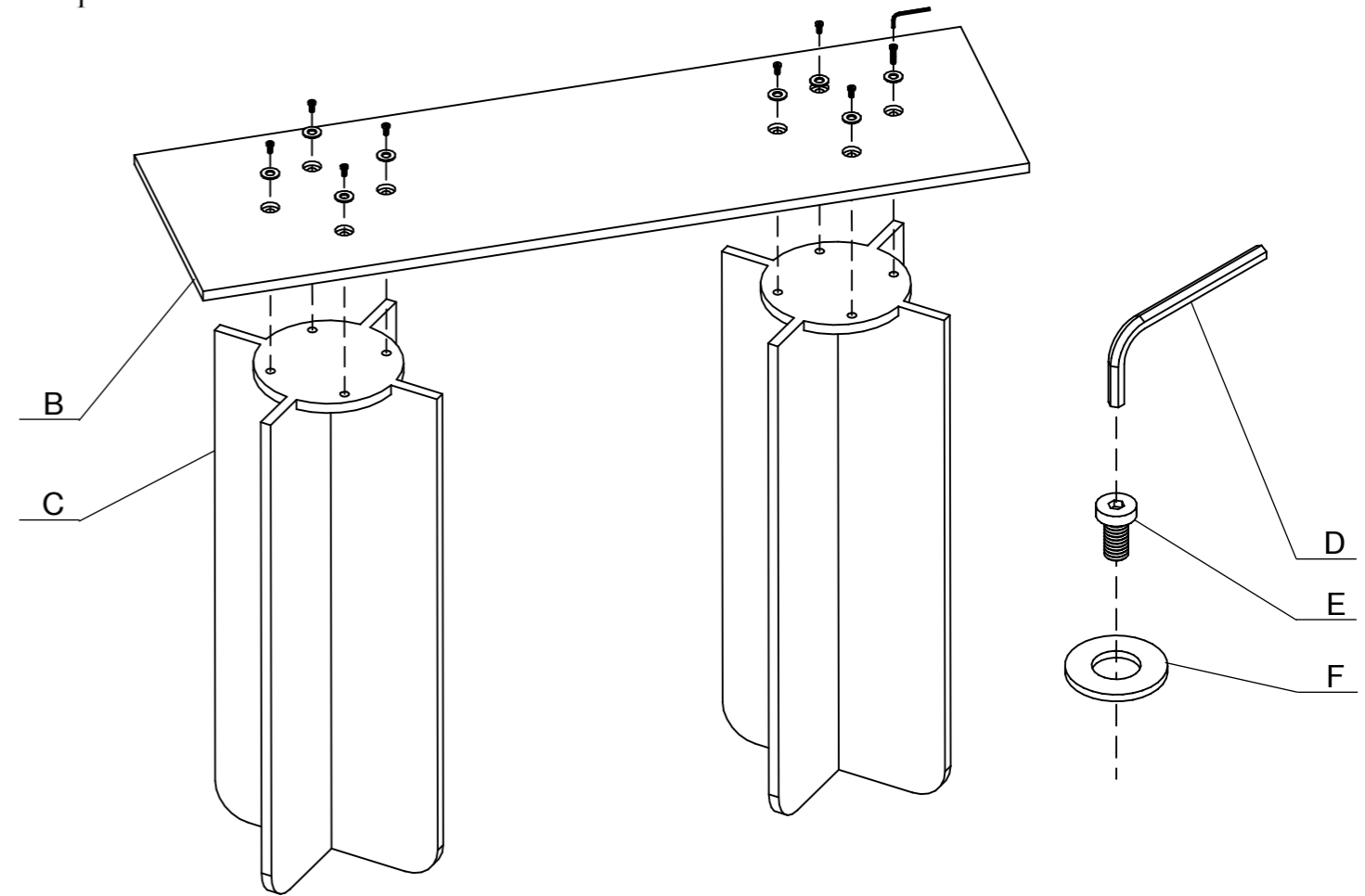

Step 2

