

ASSEMBLING GUIDE

Side Table

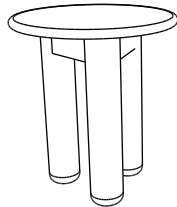

Material used

- Wood : Finishing Not Polish
- Iron : -

Box Content

- a. Table top 1 pc
- b. Legs 3 pcs
- c. Nut and rings M8 : 6 pcs
- d. Tools 1 pc

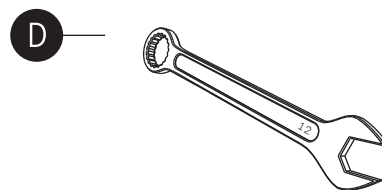
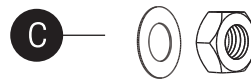
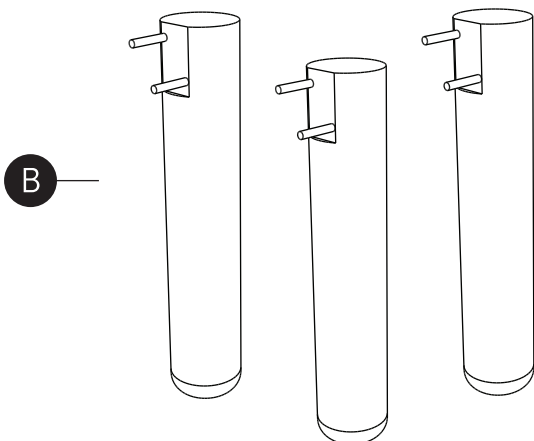
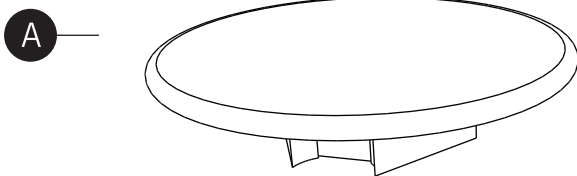

SIDE TABLE

DINO assembling guide

Bodhi[®] dbodhi.com

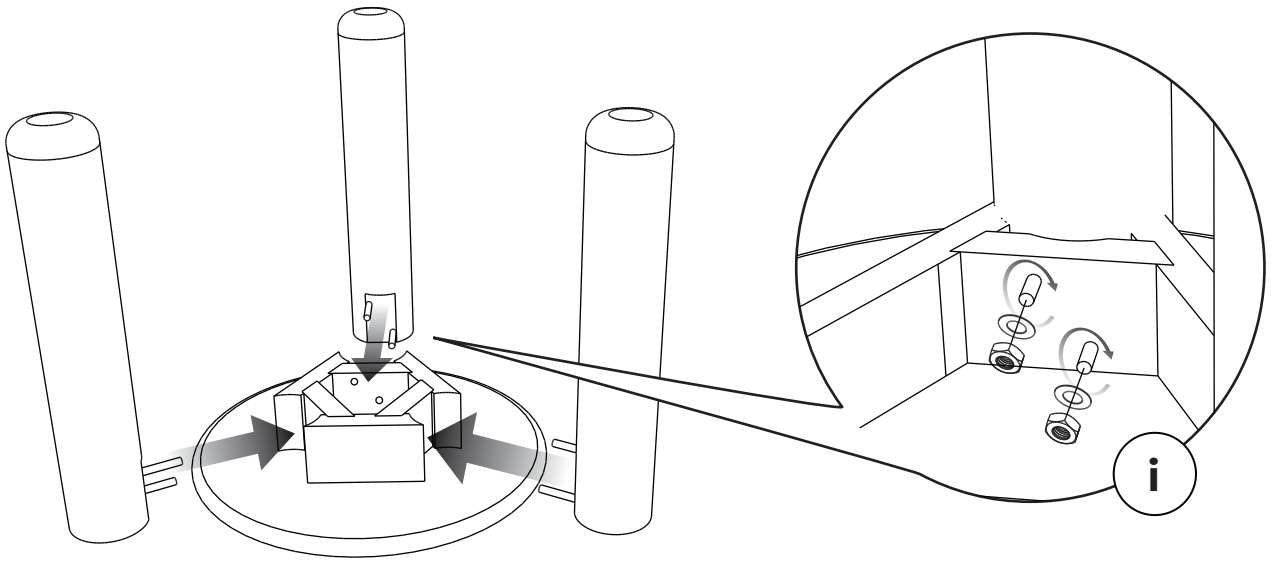

1. Install the legs into the table top as picture above and tighten with nut and rings as in detail (i)

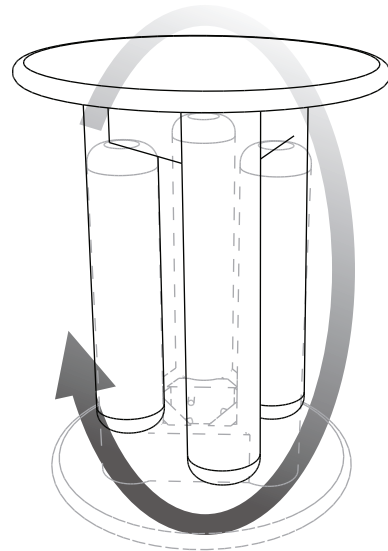

2. Rotate the table into its right position as in picture above.

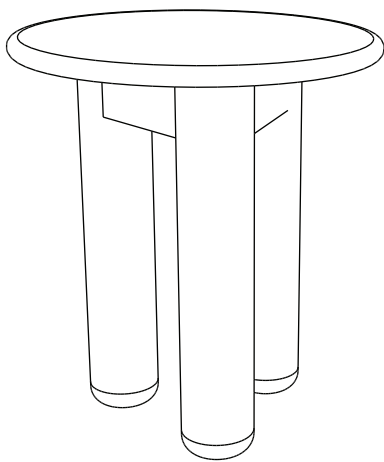

3. Your side table is ready to use!