

ASSEMBLING GUIDE

Dining Table

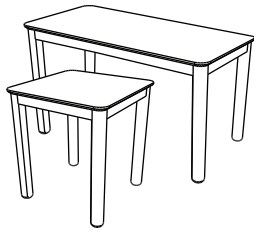

Material used

- Wood : Finishing Not Polish
- Iron : -

Box Content

- a. Table top 1 pc
- b. Legs 4 pcs
- c. Nut and rings M8 : 8 pcs
- d. Tools 1 pc

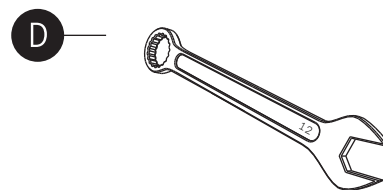
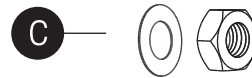
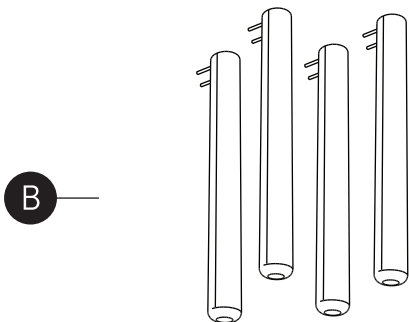
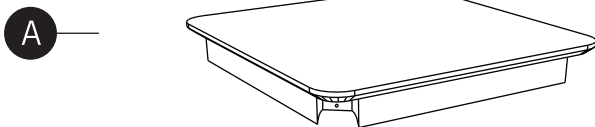

DINING TABLE

DINO assembling guide

dbodhi.com

PERSON NEEDED

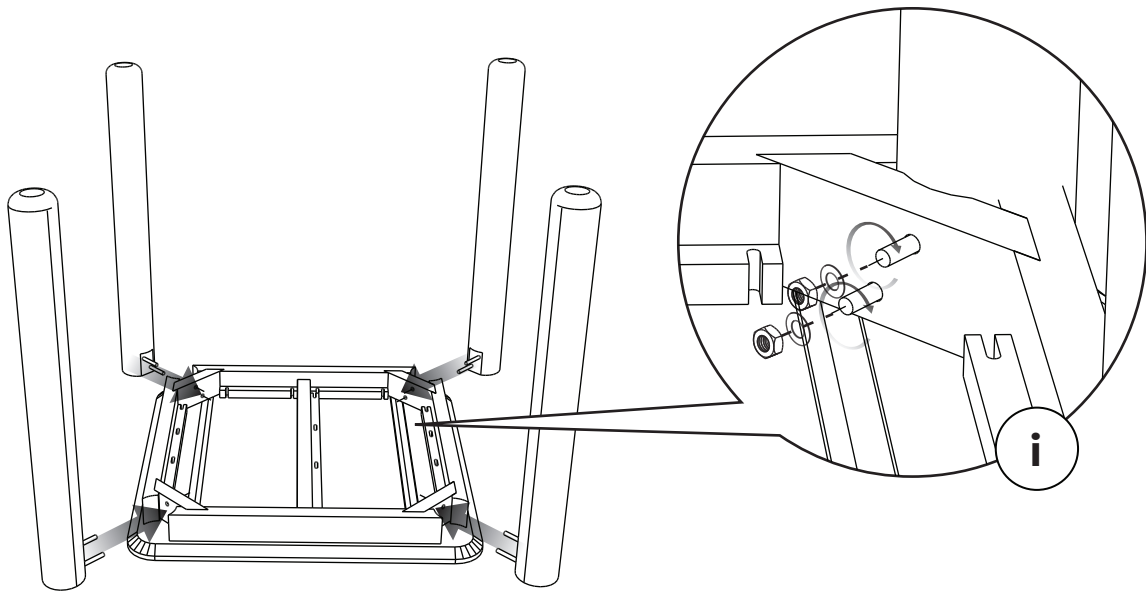

1. Install the legs into the table top as picture above and tighten with nut and rings as in detail (i)

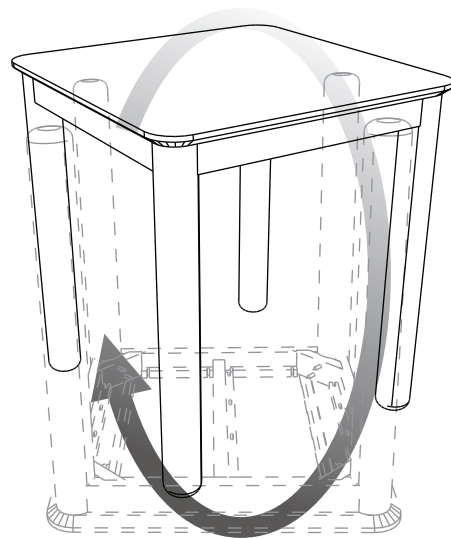

2. Rotate the table into its right position as in picture above.

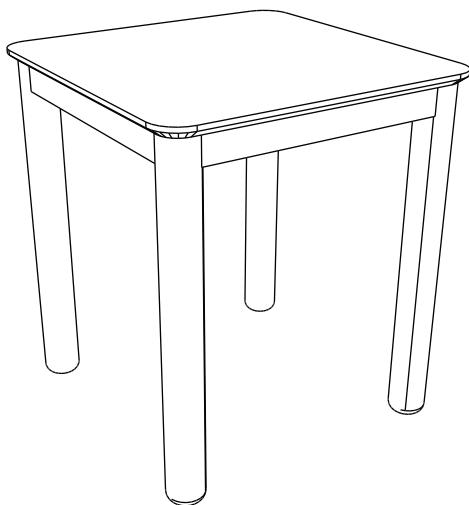

3. Your dining table is ready to use!