

ASSEMBLING GUIDE

Open Boorack 4 Shelves



Material used

Wood : Finishing Not Polish
 Iron : Black

OPEN BOOKRACK 4 SHELVES

COCO

assembling guide

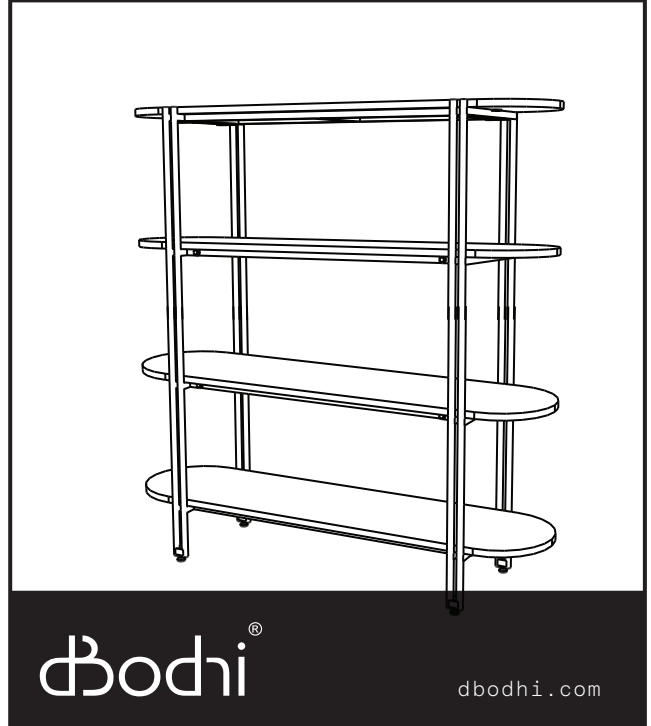

Box Content

- a. Shelves 4 pcs
- b. Frame legs 2 pcs
- c. Bolts M8x20mm and rings 24 pcs
- d. Bolts M6x20mm and rings 8 pcs
- e. Tool 2 pcs



A

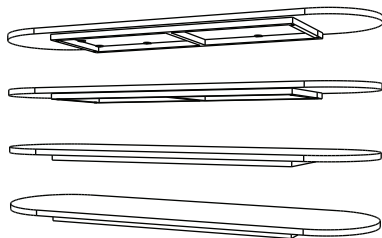

B

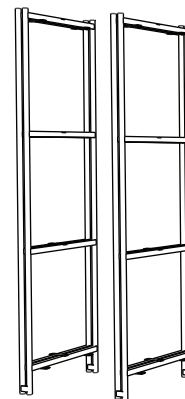

C

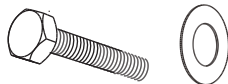

D

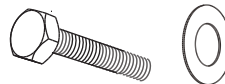

E

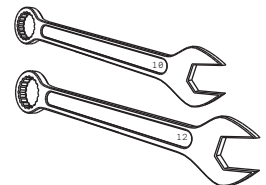

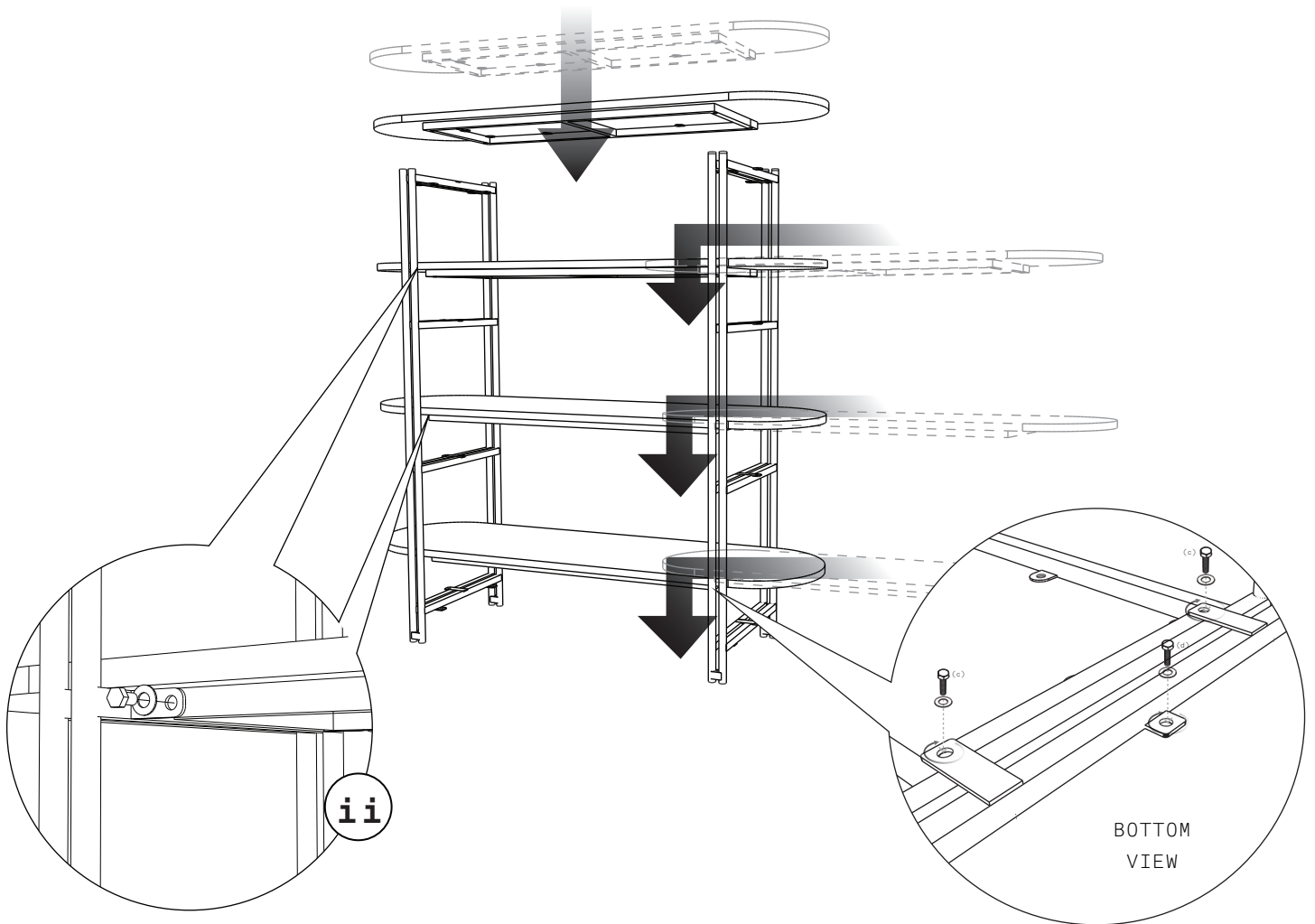

1. Place the shelves as in picture above and tighten with bolts and rings as in detail (i) and (ii).



2. Your open rack is ready.