

UNITED STRANGERS

Instruction Manual
Brownsville Sofa

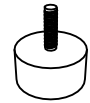
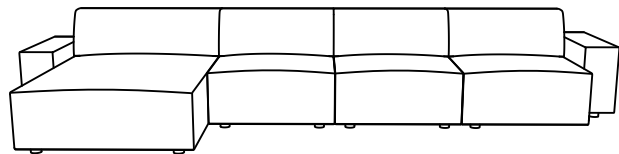

60X80

X16

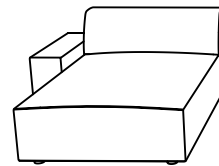

X1

(A)

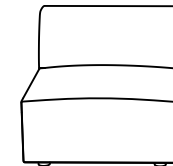

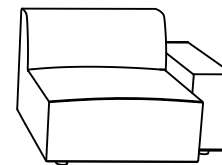

X2

(B)



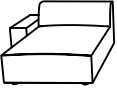

X1

(C)

NO.	PARTS LIST	Q'TY
A		1
L		4

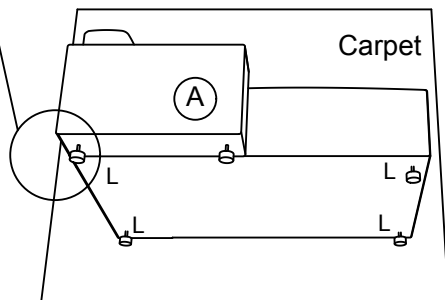
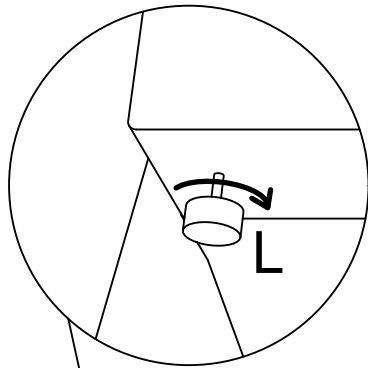
STEP1



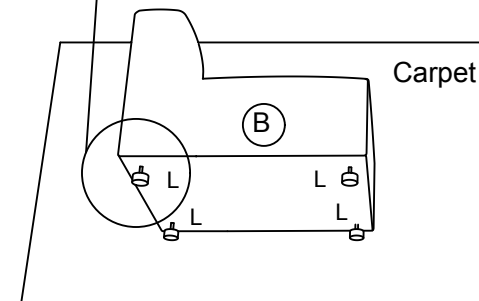
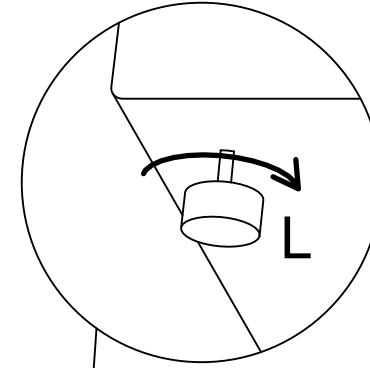

NO.	PARTS LIST	Q'TY
B		2
L		8

STEP2



X2

NO.	PARTS LIST	Q'TY
C		1
L		4

STEP3

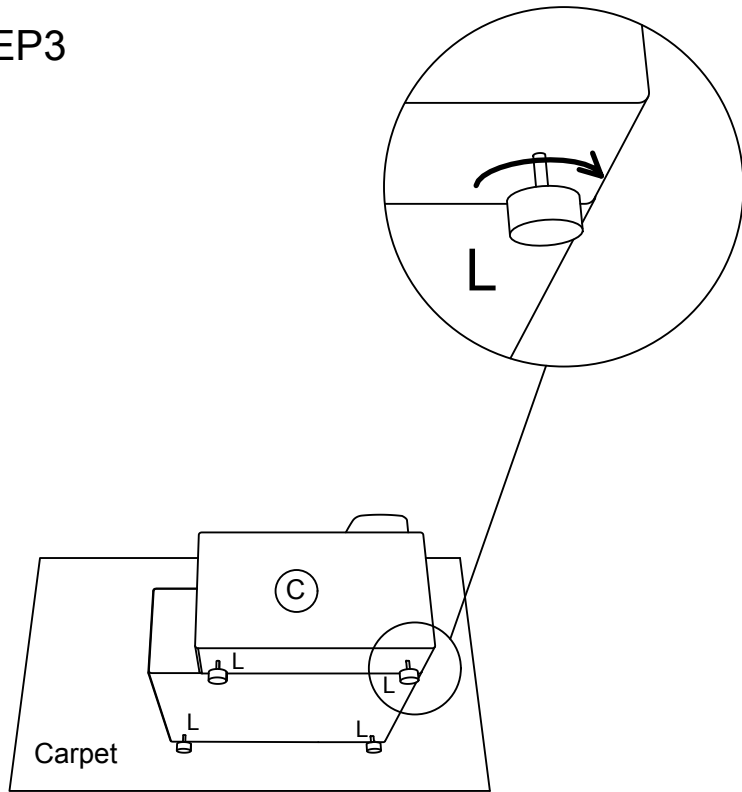

STEP4

