

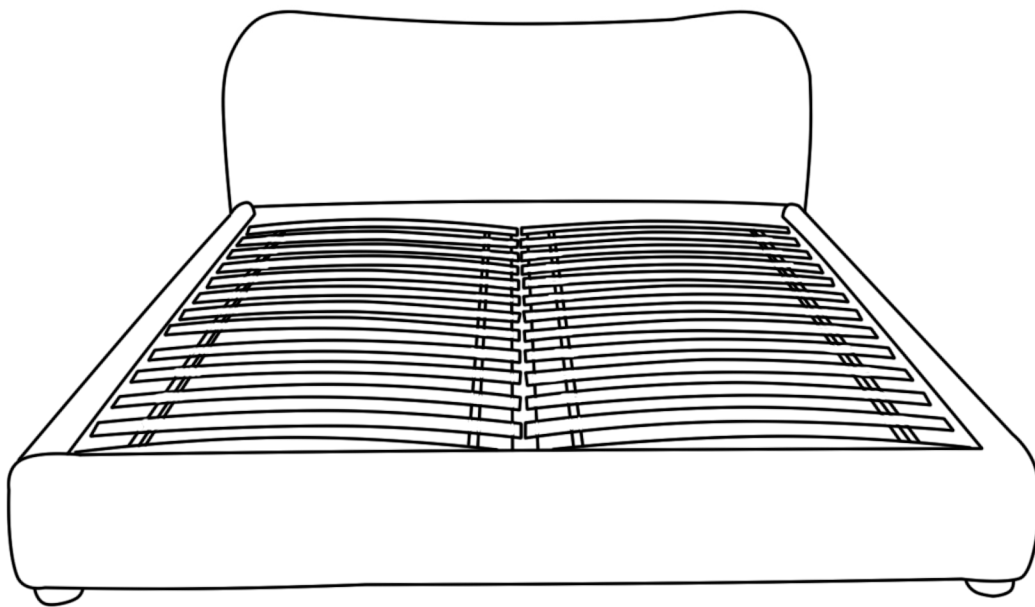







trit

Miranda Queen/King Bed



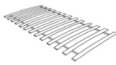

Assembly Instructions



PARTS LIST

LABEL	PICTURE	DESCRIPTION	QTY
A		HEADBOARD	1
B		RAIL	2
C		FOOTBOARD	1
D		SLAT	2
E		Support Bar	1
F		Slat Support Leg	3
G		BED LEG	4

HARDWARE

LABEL	PICTURE	DESCRIPTION	QTY
H		Cross Slat Bolt M8*30MM	12
I		Spring Washer	4
J		Metal Gasket	4
K		Slat Support Leg Bolt M8*45MM	3
L		Wrench	1



BEFORE BEGINNING ASSEMBLY:



Read instructions cover to cover



Have two adults on hand for assembly



Do NOT assemble on flooring or carpet. Assemble on a clean non-marring surface (ex: packing foam)



Save all packaging until assembly is completed

ASSEMBLY STEPS

STEP 1

Attach the bed legs(G) and ensure all legs are securely attached

Attach the side rails to the headboard and footboard using the pre attached hardware. Once the bed is assembled tighten all bolts securely.

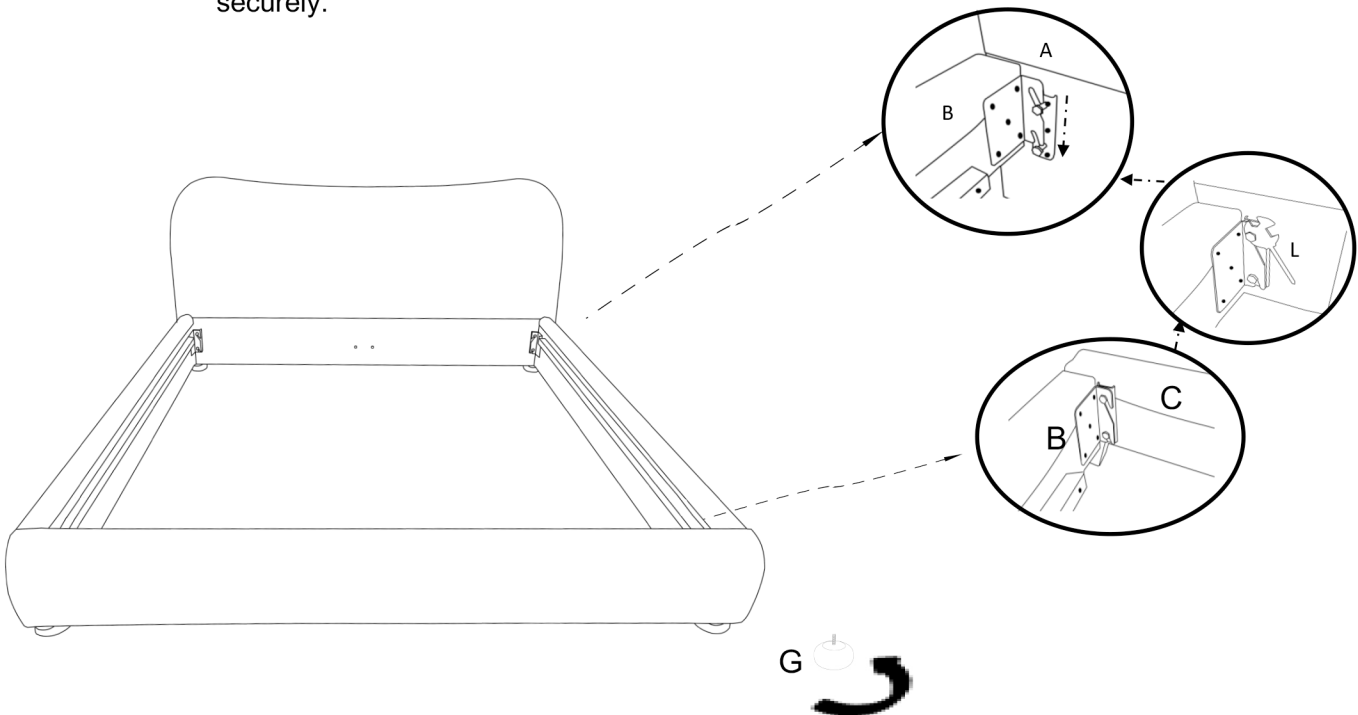

ASSEMBLY STEPS

Attach the 3 support legs to the support bar and ensure all legs are securely attached.

STEP 2 Connect the support bar to the HB and FB, secure them using the Cross Slat Bolt.

Position the slat frames inside the bed and secure them using the slat bolts. Use the included wrench to tighten them.

The slat support legs have adjustable glides and can be adjusted to level the slat frame as needed.

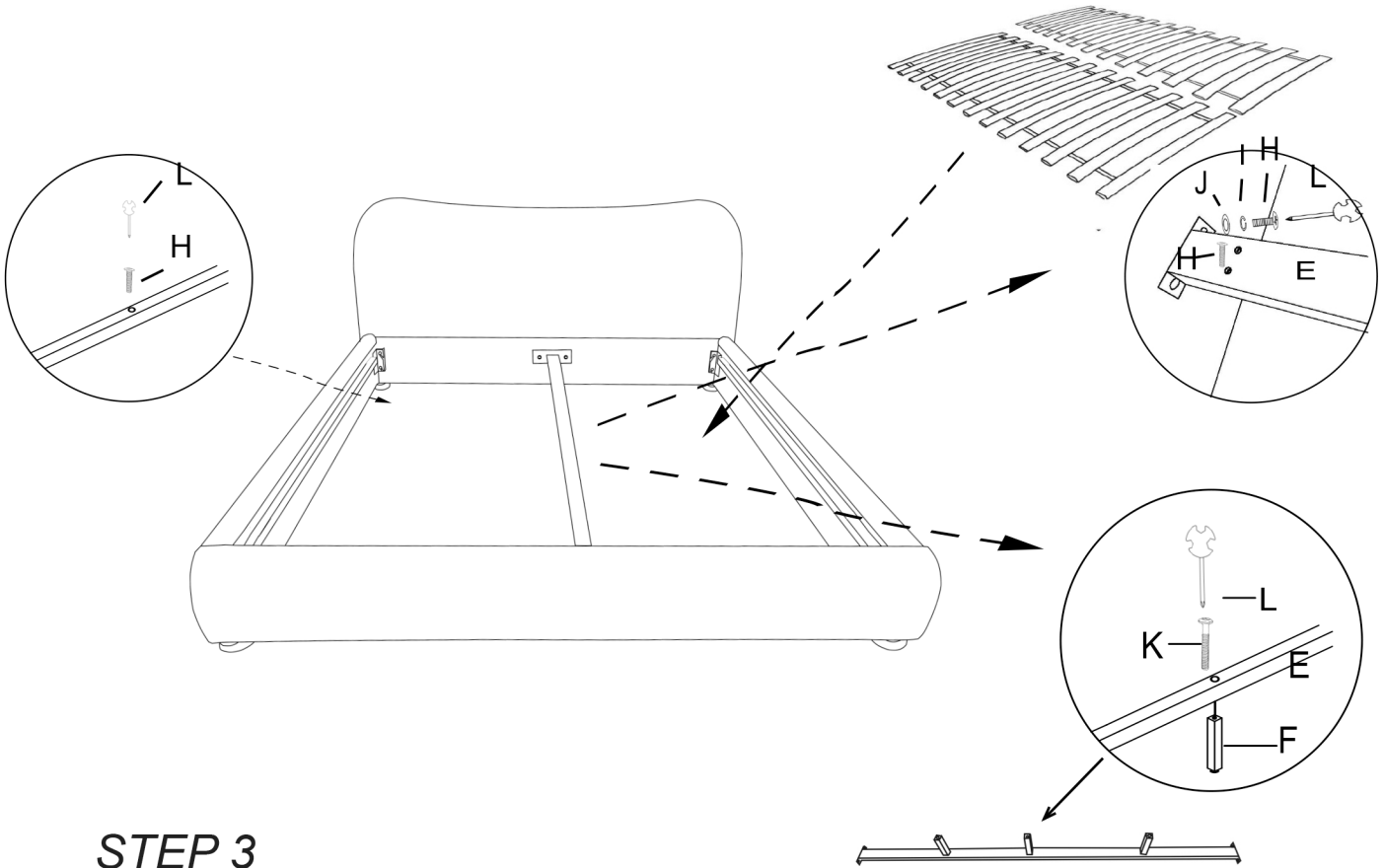

STEP 3

Assembly is complete.

