

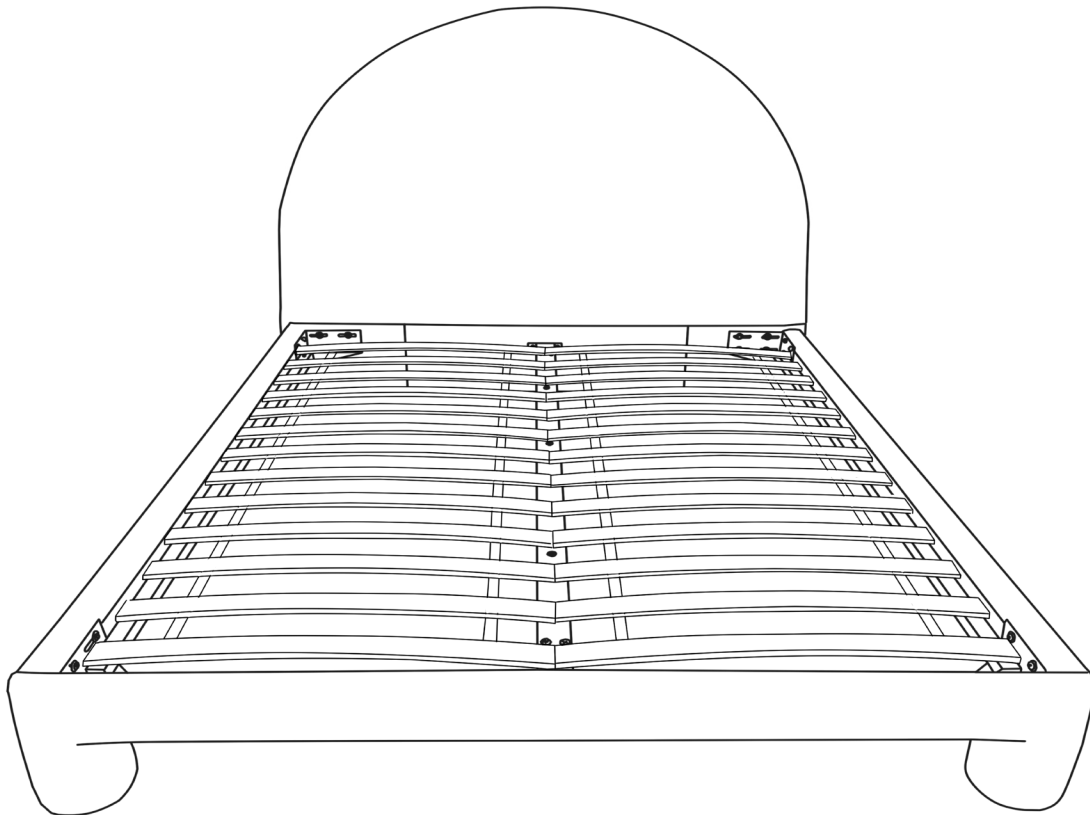





# trit

## Chase King/Queen Bed





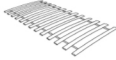

### Assembly Instructions



## PARTS LIST

LABEL	PICTURE	DESCRIPTION	QTY
<b>A</b>		<b>HEADBOARD</b>	<b>1</b>
<b>B</b>		<b>SIDERAIL</b>	<b>2</b>
<b>C</b>		<b>FOOTBOARD</b>	<b>1</b>
<b>D</b>		<b>SLAT</b>	<b>2</b>
<b>E</b>		<b>Support Bar</b>	<b>1</b>
<b>F</b>		<b>Slat Support Leg</b>	<b>3</b>

## HARDWARE

LABEL	PICTURE	DESCRIPTION	QTY
<b>H</b>		<b>Bolt M8*30MM</b>	<b>44</b>
<b>I</b>		<b>Spring Washer</b>	<b>36</b>
<b>J</b>		<b>Metal Gasket</b>	<b>36</b>
<b>K</b>		<b>Slat Support Leg Bolt M8*45MM</b>	<b>3</b>
<b>L</b>		<b>Wrench</b>	<b>1</b>
<b>M</b>		<b>Metal plate</b>	<b>4</b>
<b>N</b>		<b>Allen Key</b>	<b>1</b>



## BEFORE BEGINNING ASSEMBLY:



*Read instructions cover to cover*



*Have two adults on hand for assembly*



*Do NOT assemble on flooring or carpet. Assemble on a clean non-marring surface (ex: packing foam)*



*Save all packaging until assembly is completed*

## ASSEMBLY STEPS

### STEP 1

Attach the siderail(B) to headboard(A) and footboard(C) by using metal plate(M), Bolt(H), spring washer(I), metal gasket(J)

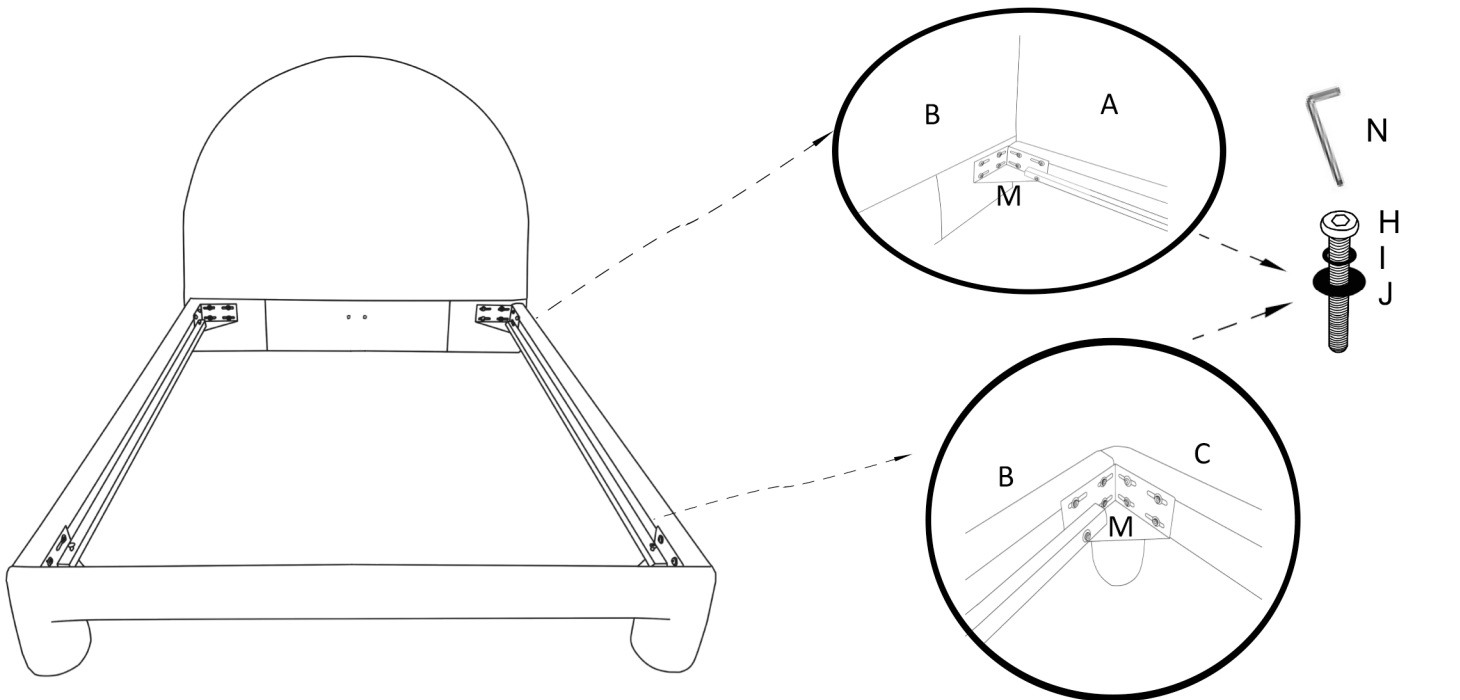

# ASSEMBLY STEPS

Attach the 3 support legs to the support bar and ensure all legs are securely attached.

**STEP 2** Connect the support bar to the HB and FB, secure them using the Cross Slat Bolt.

Position the slat frames inside the bed and secure them using the slat bolts. Use the included wrench to tighten them.

The slat support legs have adjustable glides and can be adjusted to level the slat frame as needed.

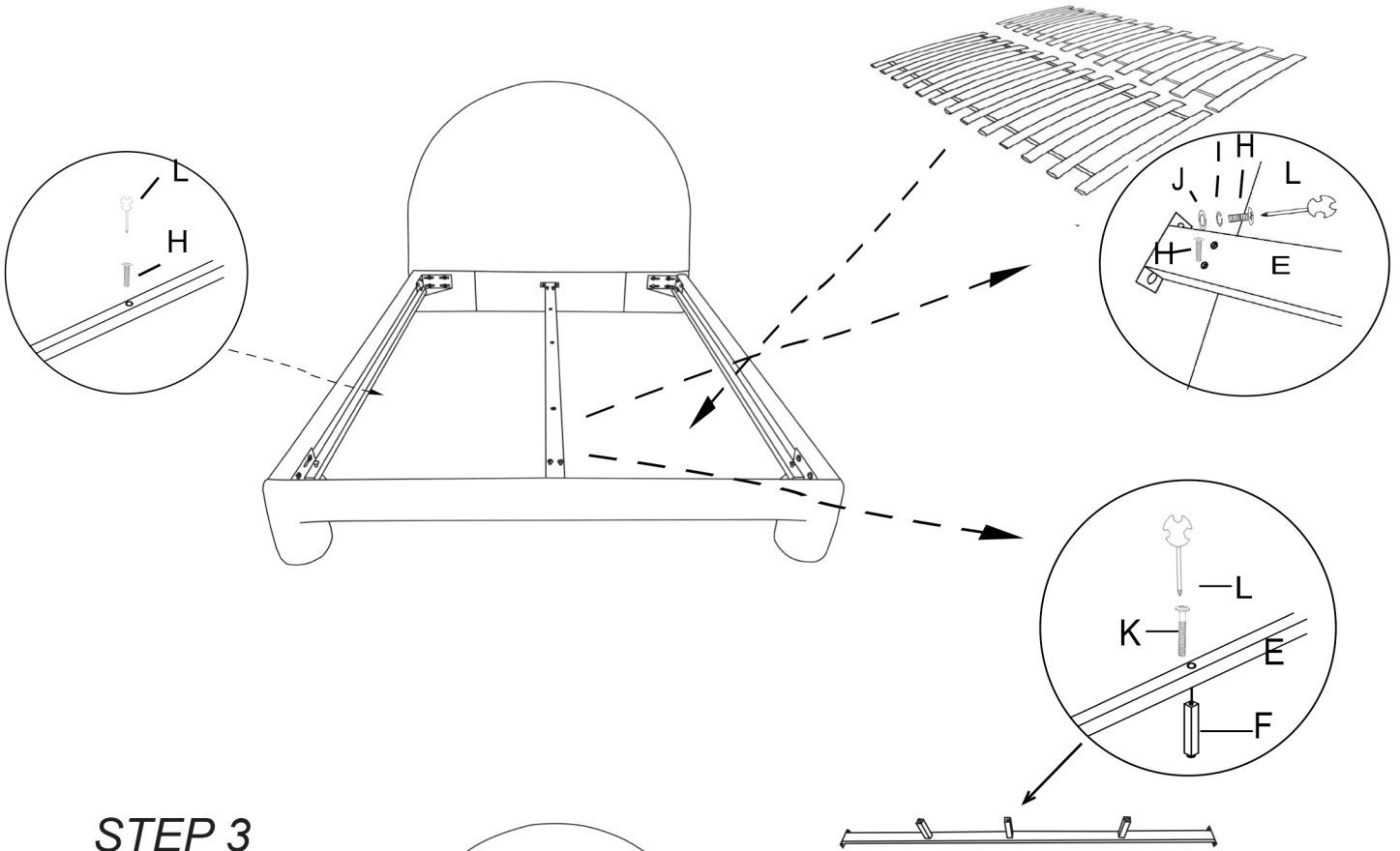

**STEP 3**

Assembly is complete.

