

WALL ART BRICKS - 100 / 100 - 120 / 90

ASSEMBLY INSTRUCTION FOR WALL ART INSTALLATION

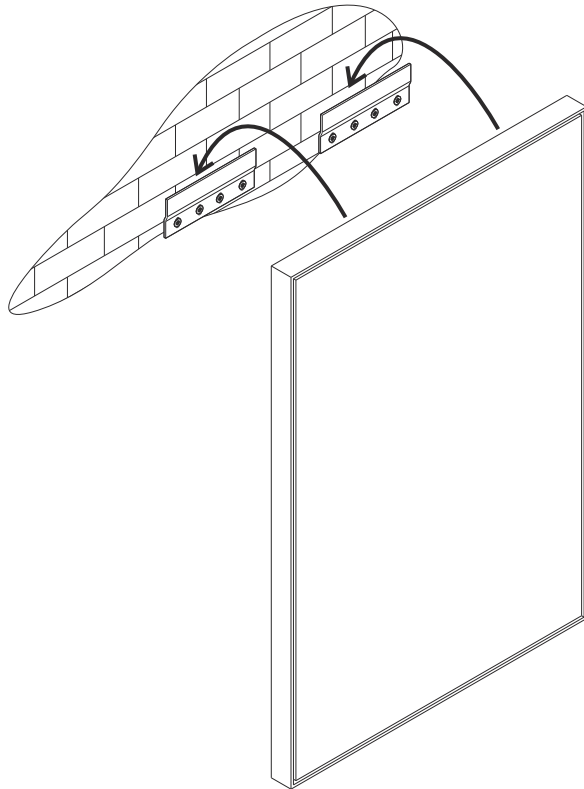

AS WALL MATERIALS VARY, SCREWS FOR FIXING TO WALL ARE NOT INCLUDED. FOR ADVICE ON SUITABLE SCREW SYSTEMS, CONTACT YOUR LOCAL SPECIALISED DEALER.



HARDWARE ENCLOSED

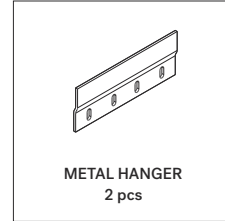

HARDWARE (not included in package)

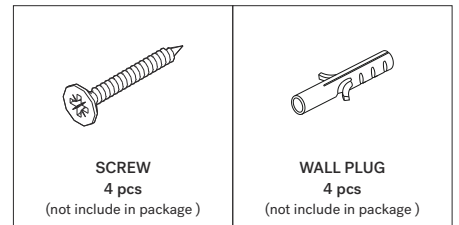

TOOLS

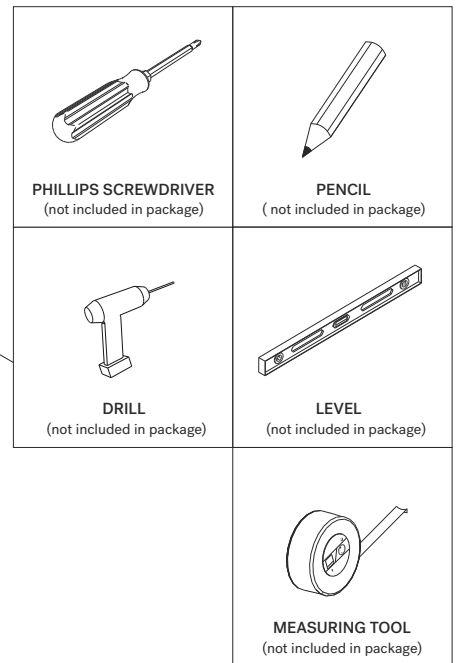

NOTICE

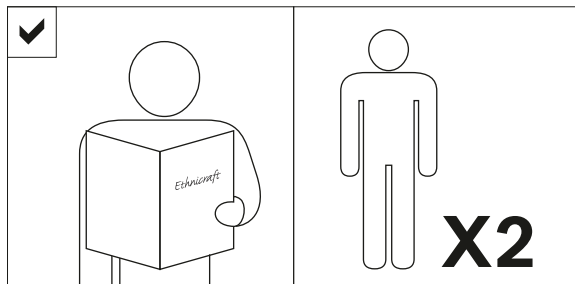

SYMBOLS



DIRECTION

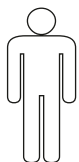

NUMBER OF PERSON NEEDED

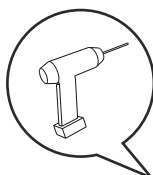

USE DRILL

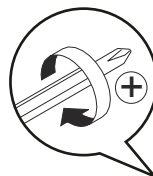

USE PHILLIPS SCREWDRIVER TO TIGHTEN

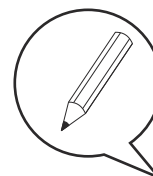

USE PENCIL



USE MEASURING TOOL

WALL ART BRICKS - 100 / 100 - 120 / 90

ASSEMBLY INSTRUCTION FOR WALL ART INSTALLATION

1 INSTALLING METAL HANGER ON THE WALL

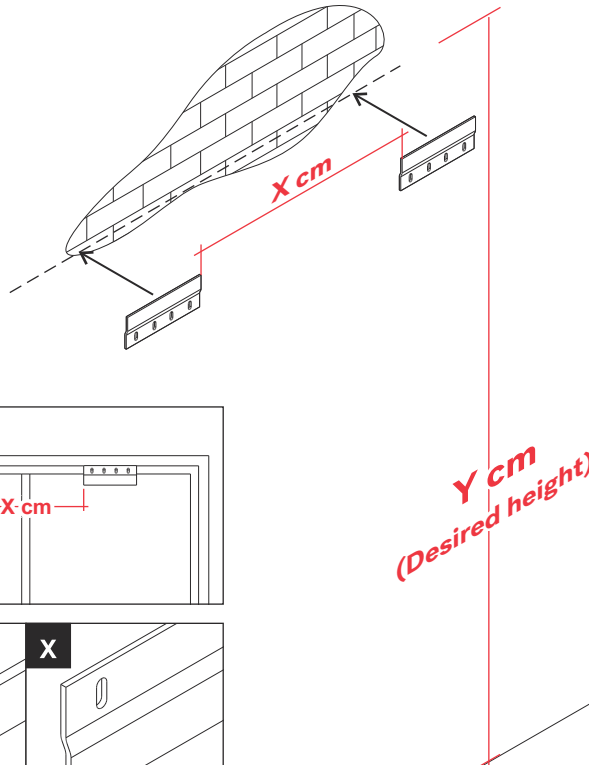

X cm

Y cm (Desired height)

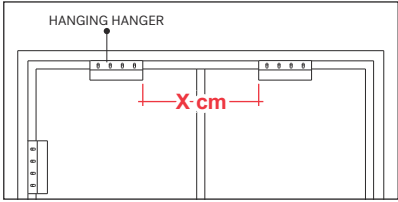

HANGING HANGER

X cm

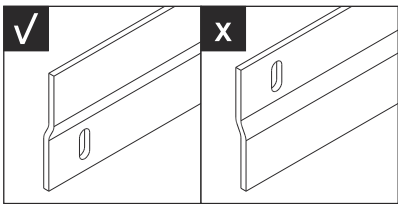

✓ X

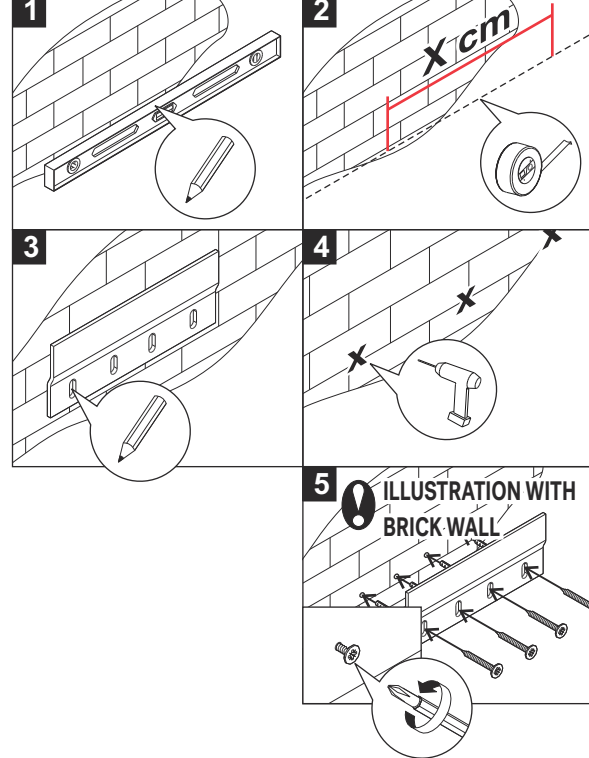

1. Use a level to mark the hanger's position.
2. Measure **X cm** from the top edge of the hanger to the brick surface.
3. Mark the wall with a pencil.
4. Drill holes into the wall.
5. **ILLUSTRATION WITH BRICK WALL**: Insert screws into the holes and tighten them.

! - TIGHTEN FULLY
- REPEAT THOSE STEPS FOR OTHER PART

2 HANGING WALL ART TO THE METAL HANGER

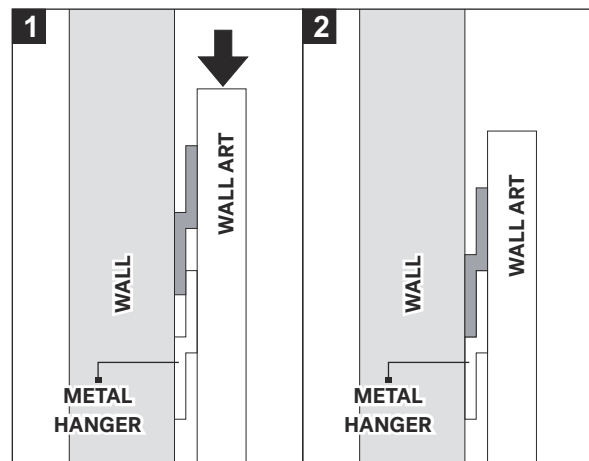
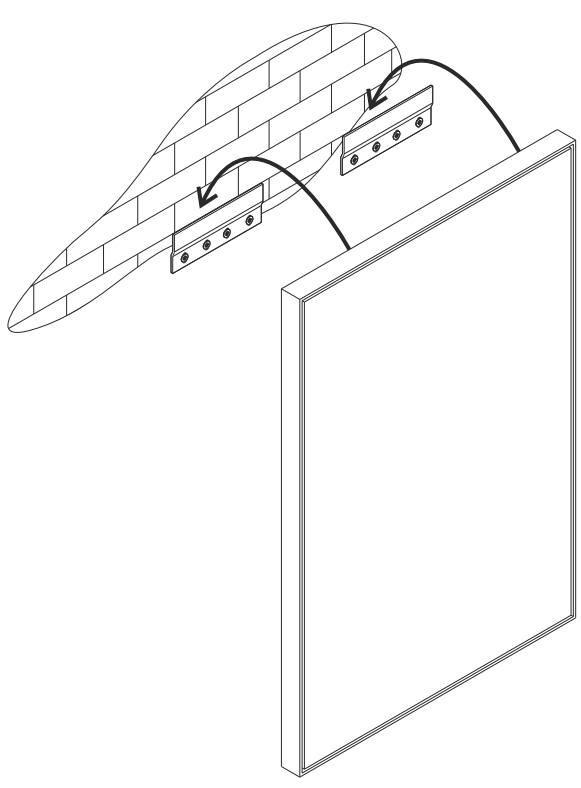

1. Lower the wall art onto the hanger.
2. Push the wall art down until it is fully seated on the hanger.

WALL

WALL ART

METAL HANGER

WALL ART BRICKS - 100 / 100 - 120 / 90

ASSEMBLY INSTRUCTION FOR WALL ART INSTALLATION

VERTICAL POSITION

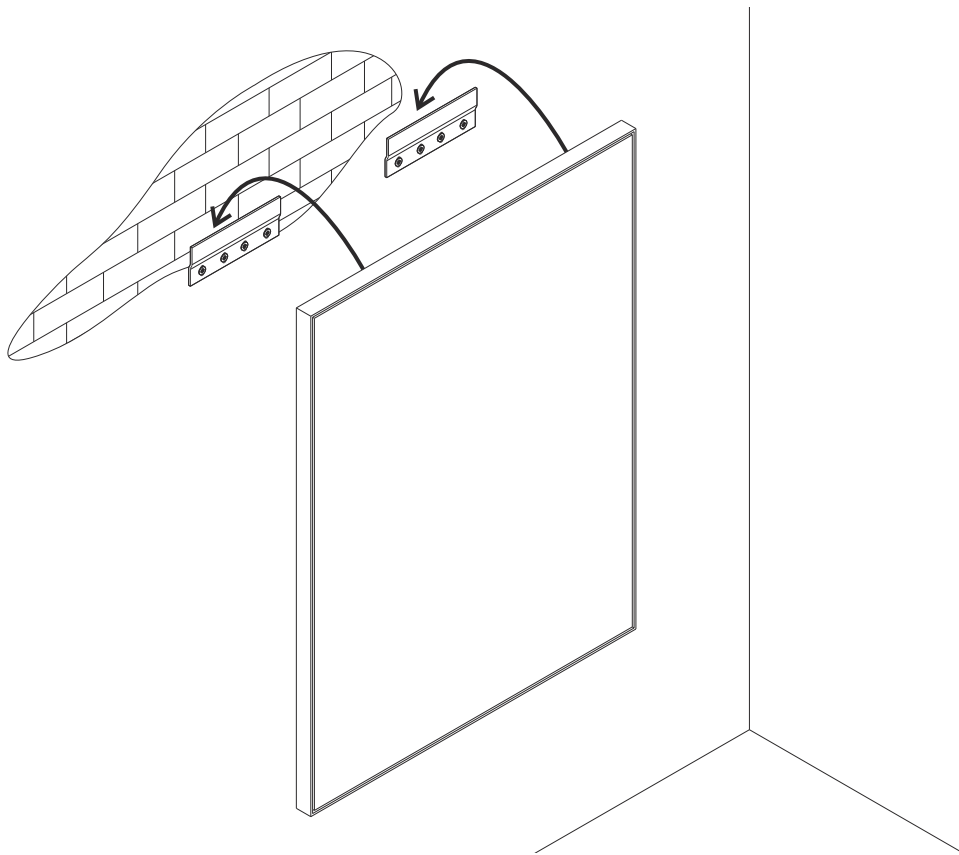

HORIZONTAL POSITION

