

SPECIFICATIONS

MODEL	HUSWSALFC1SS
Dimensions	838mm (H) x 556mm (W) x 545mm (D)
Nett Capacity	104 litres, 33 Bottles
Temperature Range	2 to 18°C
Cooling Zones	1
Shelves	4
Refrigerant	R600a

FEATURES
Stainless Steel Frame
Digital Temperature Display
Anti-Vibration Compressor Feet
Locks as Standard
LED Internal Light
3 Year Warranty

ALFRESCO WINE COOLER

HUSWSALFC1SS

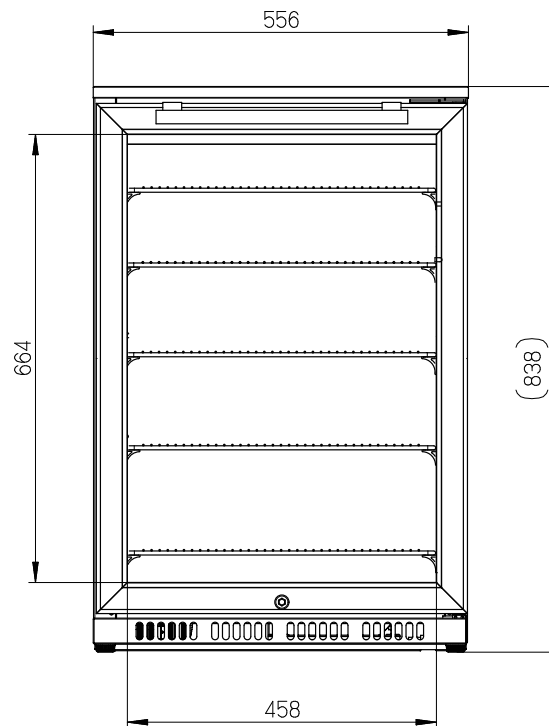

THE KEYS TO PRESERVING THE NATURAL TASTE OF WINE



TEMPERATURE

Although varying temperatures are used for serving, all wines should be stored between 12°C - 14°C. Storing your wine outside of these temperatures can spoil the natural taste.



HUMIDITY

Storing wine at lower than 50% humidity can lead to the cork drying out and shrinking. This can lead to air entering inside of the wine bottle leading to oxidation and odours.



LIGHTING

High amounts of light, particularly damaging UV rays can effect the natural colour and tannins within your wine. This can lead to damaging hydrogen sulphide compounds developing within the wine.



VIBRATIONS

Slight vibrations can accelerate the natural ageing process of wines and lead to a deterioration in flavour and an overall lack of quality.



AIRFLOW

A lack of airflow within a wine cabinet can lead to poor ventilation, stale air and sometimes mould. Active carbon filters help to eliminate odours that can develop within the wine cabinet.