

REVISION RECORD			
Jamming		First Release	RC01 2020/03/31
Jamming	PIXS32-PIN7s use for TELEM2	RC02	2020/04/23

Note:

- 1.if DSM_IN and SBUS_IN share the same Connector PIN, PPM_IN use individual connector tie SPEKTRUM_DSM_IN and SBUS_ININPUT nets together directly
- 2.if PPM_IN and SBUS_IN share the same Connector PIN, DSM_IN use individual connector tie PPM_IN and SBUS_ININPUT nets together directly
- 3.RSSI_IN and SBUS_OUT nets can be tied together directly to share the same connector PIN

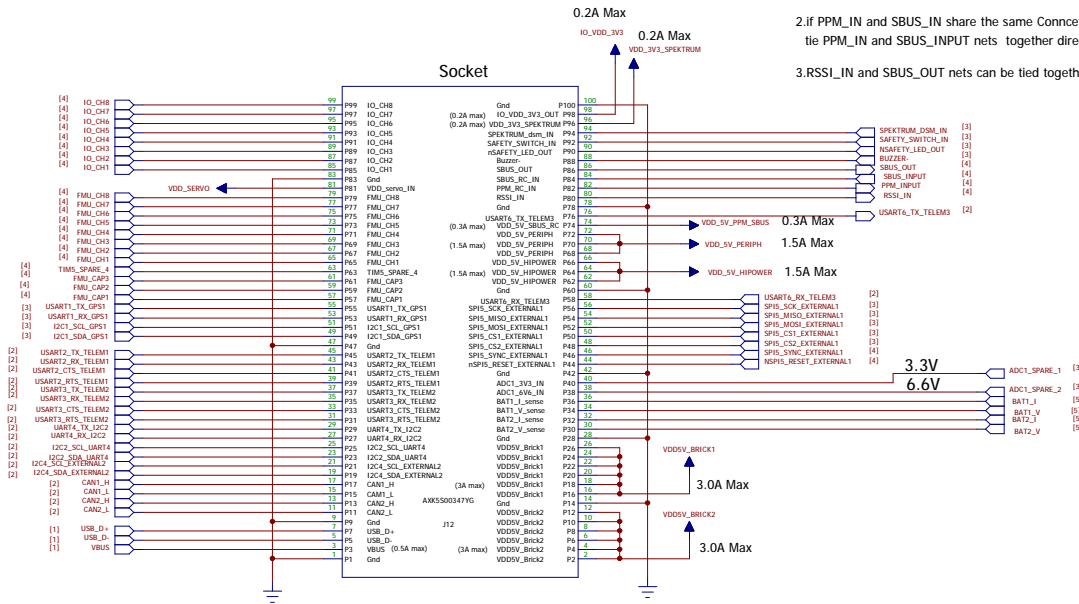

D

D

C

C

B

B

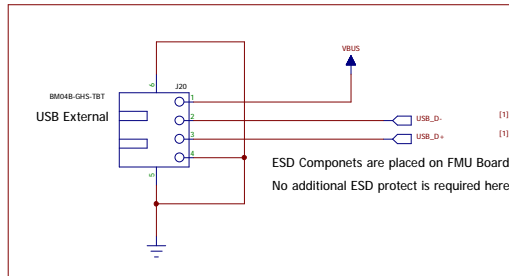

A

A

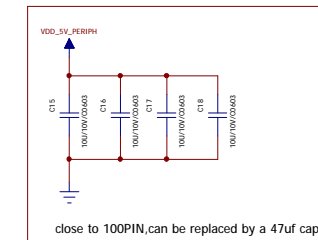
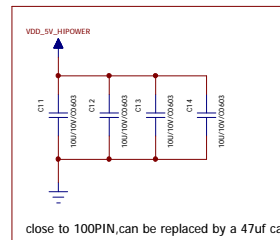
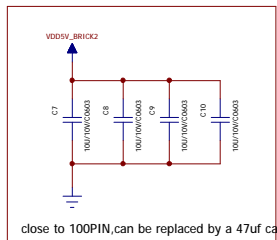
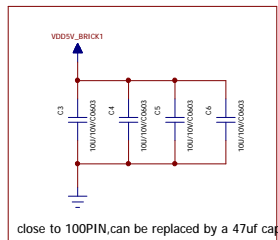

COMPANY:				Holybro			
TITLE:				PIX32-V5-BASE			
DRAWN:	Jamming	DATED:	2020/02/25	CODE:	028	SIZE:	A2
CHECKED:	Jamming	DATED:	2020/02/28	Sheet:	100Pin BreakOut		REV:
QUALITY CONTROL:		DATED:					RC02
RELEASED:	Jamming	DATED:	2020/04/23	SCALE:	1:1		SHEET: 1 of 5

REVISION RECORD			

6

5

4

3

2

1

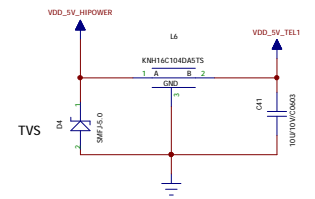
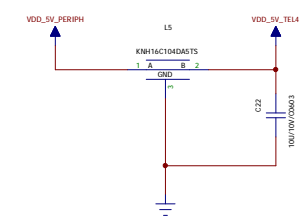
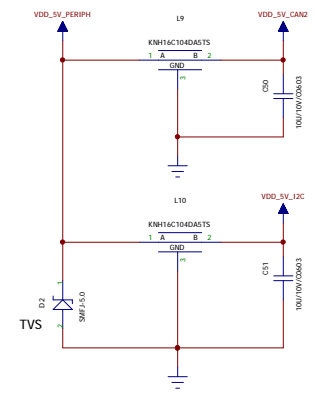
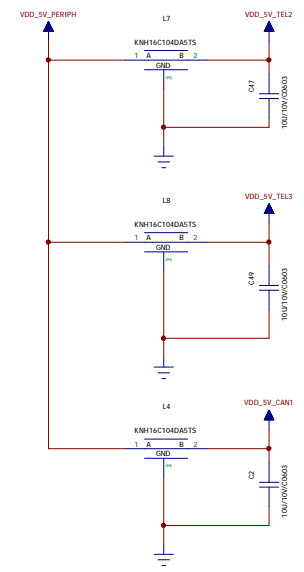
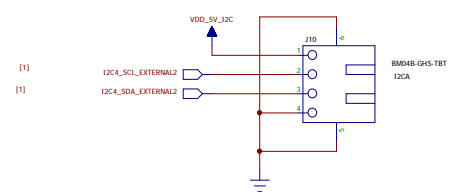
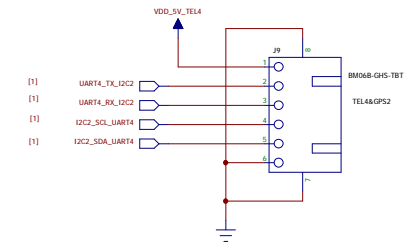
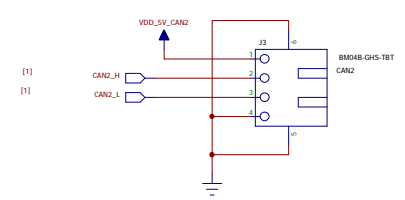
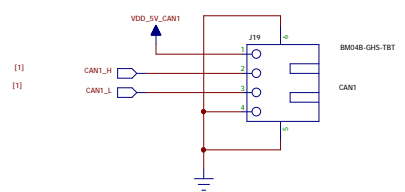
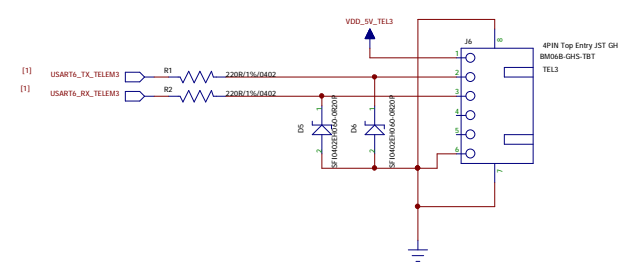
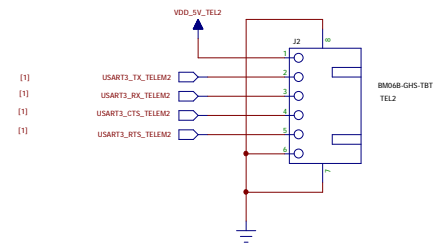
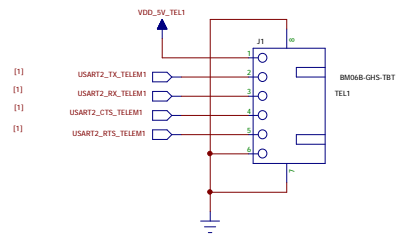

COMPANY: Holybro			
TITLE: PIX32-V5-BASE			
DRAWN: Jamming	DATED: 2020/02/25	CODE: 028	SIZE: A2
CHECKED: Jamming	DATED: 2020/02/28	Sheet: UART-I2C-CAN	REV: RC02
QUALITY CONTROL:	DATED:	SCALE: 1:1	SHEET: 2 of 5
RELEASED: Jamming	DATED: 2020/04/23		

D

C

B

A

D

C

B

A

6

5

4

3

2

1

REVISION RECORD			
LTR	ECO NO.	APPROVED:	DATE:

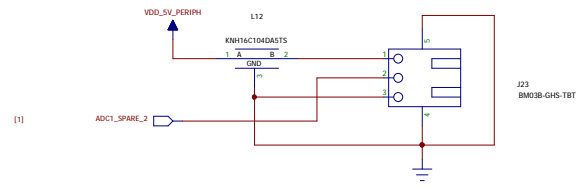
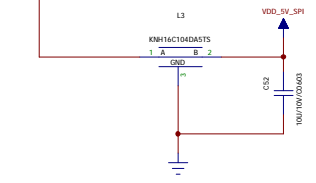
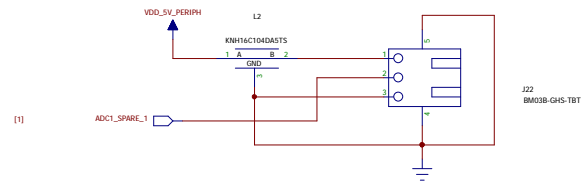
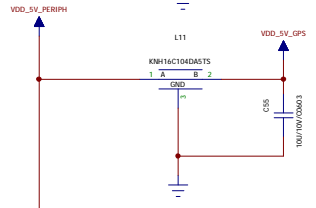
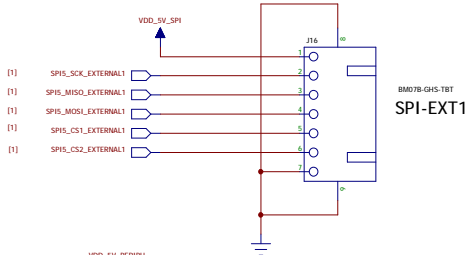
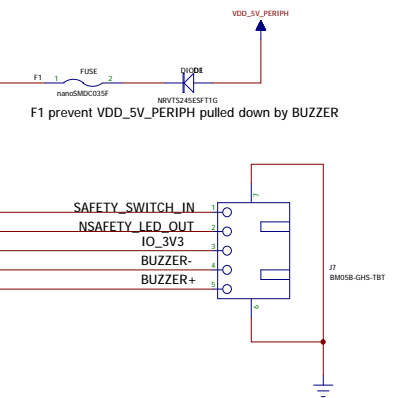
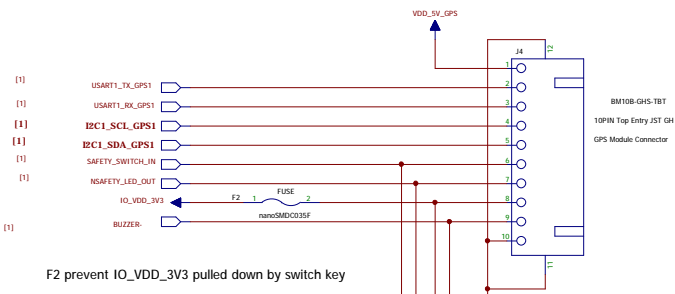
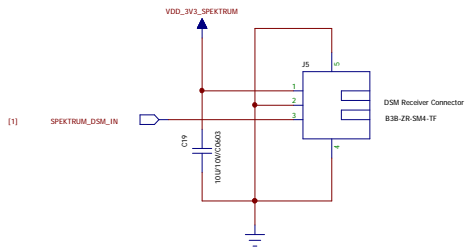

COMPANY: **Holybro**

TITLE: **PIX32-V5-BASE**

DRAWN: Jamming	DATED: 2020/02/25
CHECKED: Jamming	DATED: 2020/02/28
QUALITY CONTROL:	DATED:
RELEASED: Jamming	DATED: 2020/04/23

CODE: 028	SIZE: A2	Sheet: GPS-SPI-RC	REV: RC02
SCALE: 1:1		SHEET: 3 of 5	

6

5

4

3

2

1

REVISION RECORD			
LTR	ECO NO:	APPROVED:	DATE:

ESD Componets are placed on FMU Board
No additional ESD protect is required here

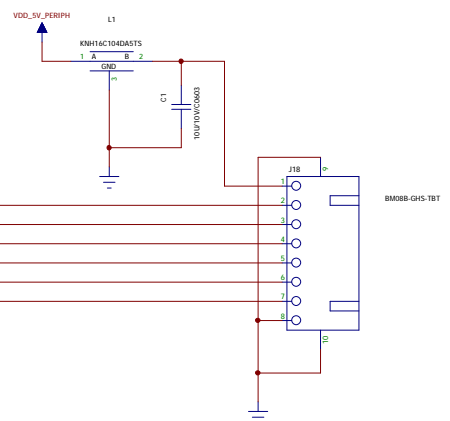
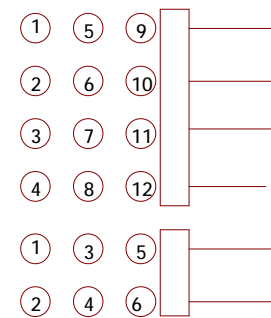
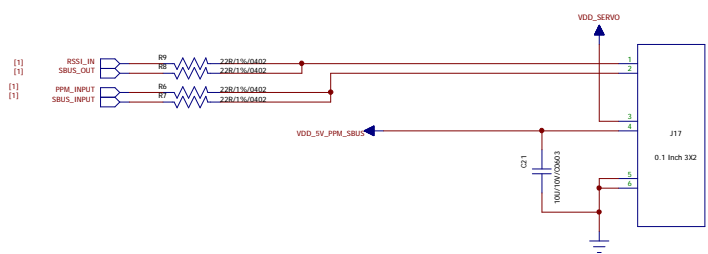
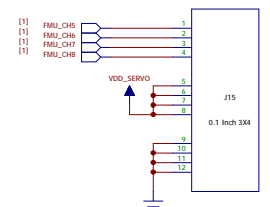
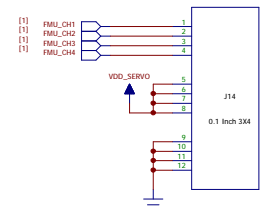
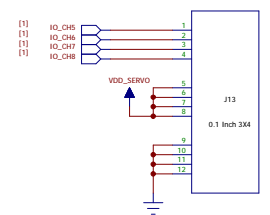
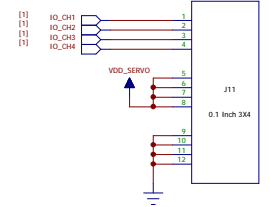

D

C

B

A

D

C

B

A

COMPANY: Holybro			
TITLE: PIX32-V5-BASE			
DRAWN: Jamming	DATED: 2020/02/25	CODE: 028	SIZE: A2
CHECKED: Jamming	DATED: 2020/02/28	DRAWING NO: Servo Out	REV: RC02
QUALITY CONTROL:	DATED:	SCALE: 1:1	
RELEASED: Jamming	DATED: 2020/04/23	SHEET: 4 of 5	

6

5

4

3

2

1

REVISION RECORD			

D

D

C

C

B

B

A

A

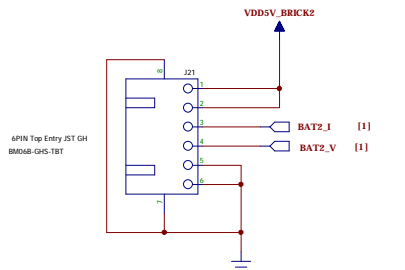
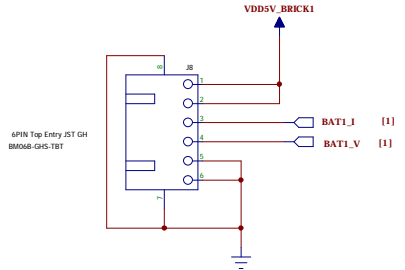

4 hole,M3

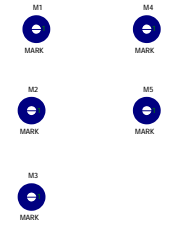
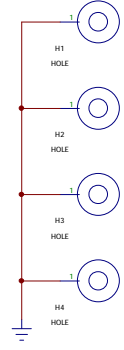

DRAWN: Jamming		DATED: 2020/02/25		COMPANY: Holybro			
CHECKED: Jamming		DATED: 2020/02/28		TITLE: PIX32-V5-BASE			
QUALITY CONTROL:		DATED:		CODE: 028	SIZE: A2	SHEET: BAT-SENSE	REV: RC02
RELEASED: Jamming		DATED: 2020/04/23		SCALE: 1:1		SHEET: 5 OF 5	