

Pipe Inspection Camera System User Manual



Model No: F5100DJKABTX

NOTE: All accessories are under the keyboard!

Please contact us at first time if you got issues with the product

Amazon Orders After-sale: support@sanyipace.com

Website Orders After-sale: service@sanyipace.com



- Scan this QR code to get the electronic version of the instruction in English.
- Scannen Sie diesen QR -Code, um die elektronische Version der Anweisung auf Deutsch abzurufen.
- Scannez ce code QR pour obtenir la version électronique de l'instruction en français.
- Escanee este código QR para obtener la versión electrónica de la instrucción en español.
- Scansiona questo codice QR per ottenere la versione elettronica delle istruzioni in italiano.

Catalog

1. Notice	1
2. Scope of Product Use	1
3. Product Specification	1
4. LCD Monitor Operation	3
5. Counter Function	5
6. Control Panel & Keyboard Input	5
7. Camera with Self-leveling Function & 512Hz Transmitter	6
8. Cable Coil	8
9. Battery & Adapter	8
10. Device Installation	9
11. Structure & Accessories	11
12. Assemble & Disassemble Box	11
13. Trouble & Troubleshooting	13
14. Warranty	20

Attention: The illustrations and screenshots of this manual are to explain the product's operation, which may be a little different from actual products due to the products' version upgrades and different production batches. If the content in this manual does not match your machine, please refer to the machine!

1. Notice

- a. Please read the manual carefully before using the product.
- b. Handle the device with care when operating, do not drop or push hard.
- c. Do not dismantle the machine without permission.
- d. Please turn off the monitor and disconnect the device after use.
- e. Before inserting the TF card into the device, please back up the information on the TF card to avoid loss of information.
- f. Do not cut off the power suddenly during recording and playback, otherwise, the product and video files may be damaged.

2. Scope of Product Use

- a. Household pipeline blockage inspection
- b. Pipe inspection camera, pipeline tools
- c. Underground water pipes, HVAC systems, oil and gas pipelines
- d. Rescue operations in narrow spaces
- e. For underground exploration
- f. Scientific research on underwater riverbeds
- g. Sewer system inspection
- h. Any other hard-to-reach locations/areas

3. Product Specification

---Camera and Cable---

Sensor: 1/3 CMOS

Resolution: AHD 1080P

Camera diameter: 0.9in/23mm (built-in 512Hz transmitter, self-leveling)

Camera light source: 12pcs 1W high white LED (adjustable)

Camera angle: 145 degrees

Camera material: stainless steel, sapphire lens, IP68 waterproof

Camera protective cover size: 1.5in*1.1in/38mm*28mm

Camera pipe pulley: 3.9in*1.8in/99mm*45mm

Cable diameter and material: 164ft/50m and 230ft/70m of 0.2in/5mm harder

high elastic cable; 131ft/40m of 0.28in/7mm hardest high elastic cable (optional)

---Monitor Screen---

Size: 9-inch

Camera/monitor picture: IPS LCD color

Function: Video recording, audio recording, speaker, capture photos, 5X digital zoom, battery level display, depth counter, 512Hz transmitter, self-leveling, keyboard input (support English), etc.

Monitor input voltage: DC 12V

TF card: package includes a 16GB TF card, support max 128GB

Display resolution: 1024*600 IPS

Menu Language: Chinese/English/Russian/French/German optional

Screen port: power input/video

Screen operation: press buttons

Video format: AVI

Photo format: JPG

Working temperature: -4~140°F / -20~60°C

Storage temperature: -22~176°F / -30~80°C

---Control Panel---

Switch on/off

Five-speed LED adjustment

Meter/feet switch function

Meter/feet cleared function

Keyboard input

---Battery---

Charger: 100VAC-240VAC/DC 12.6V 1000MA

Battery: lithium battery 4500mAh

Battery continuous working time: about 6-8 hours

4. LCD Monitor Operation



TF card: including 16GB, maximum support 128GB card
Built-in microphone and speaker

Display Operation :

- Turn On

Connect all the cables of the device, turn on the battery switch button and press the power button on the screen, and the system starts.

- Menu Settings (need to exit REC mode):

Press the "MENU/EXIT" key to enter the menu settings.

Press "<" ">" to select, press "Rec/-" to confirm, and press "EXIT" to return.

Allow operating time setting/playback setting/display setting/recording setting/system setting.

- How to Record Video:

Press "REC/-" to start recording (video with audio), press again to stop recording.

- How to Playback Images/Videos:

Press "PLAY/+" to enter image browsing, press it again to enter video playback, press "<" ">" button to select, press "REC/-" to play, press "REC/-" again to exit.

- How to Take Photos:

Press ">/PHOTO" to capture a photo, press one at a time.

- How to Zoom the Image While Recording:

Press "<" to zoom in 0-5 times, press the 6th time to return to normal (0).

- How to Delete Pictures or Videos:

Press "PLAY/+" to enter photo/video viewing, press ">" to select one of the pictures or videos, press "MENU/EXIT" and ">" to enter delete or all delete options, press "REC/-" to confirm, press "PLAY/+" again to exit.

- How to Modify Video Length:

The recorded video will be divided into fixed-length videos and stored in the memory card, and the default length is 3 minutes. You can adjust it up to 10 minutes. Press "MENU/EXIT" and ">/PHOTO" to select "Video Menu", press "REC/-" to change it to 1mins, 3mins, 5mins, or 10mins, and press "Menu" to exit after setting.

- How to Set Recording without Audio:

Press "MENU/EXIT" and ">" to select "System Settings", press "REC/-" to enter sub-options, press ">" to find "Sound Settings", press "REC/-" to adjust turn on or off, press "MENU/EXIT" to quit.

5. Counter Function

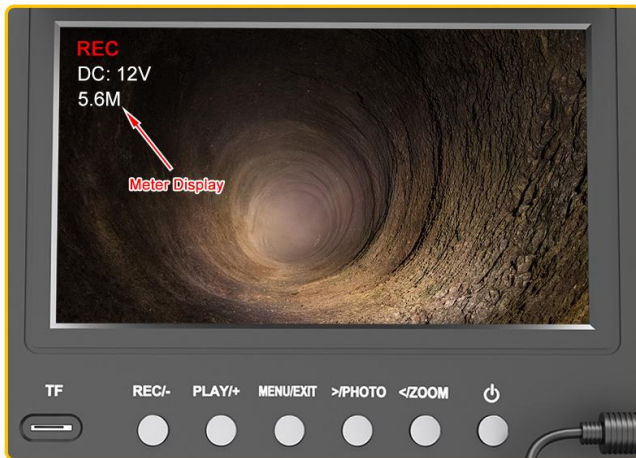

Counter
Reset Button



F7 key:
Counter Cleared



F4 key:
Feet/Meter Switch

Before using this function, please press the CLEAR button or F7 key to clear the counter information. You can toggle the display in feet or meters by pressing the F4 key. It will start counting feet/meters when the coil rotates, and display it on the screen in real time.

6. Control Panel & Keyboard Input



- ① Power charging port
- ② Battery switch (Note: please turn off the switch when not in use)
- ③ Counter reset button

- ④ LED brightness adjustment (0-5 gear)
- ⑤ Power indicator light
- ⑥ Second keyboard USB port (The first USB Port is under the control panel)
- ⑦ Esc: Clear characters
- ⑧ F4 key: Meter/Feet switch
- ⑨ F5 key: OSD switch (on-screen display)
- ⑩ F6 key: LED brightness adjustment (0-5 gear)
- ⑪ F7 key: Clear counter
- ⑫ F9 key: Factory setting (Press F9 then input password "3131" to enter settings, press ⑬ UP/Down to select cable's diameter and meters, Left/Right to select model (5100 is the correct model), then press F9 to save settings and exit)

The function of the keyboard: During working, you can input text/symbols/numbers to mark events.

7. Camera with Self-leveling Function & 512Hz Transmitter

Camera probe size details:



The Camera probe has a built-in 512Hz transmitter, which transmits a 512Hz frequency signal through a built-in chip, compatible with any 512Hz pipe locator.



Transmit Frequency: 512Hz

Output Waveform: sine wave

Transmit Distance: about 16.4ft/5m

Self-leveling can be defined as the ability of any instrument to level itself regardless of the angle of inclination.

Camera probe is equipped with a self-leveling gravity bearing on the camera probe that could automatically adjust direction and level when taking videos/pictures to deliver upright pictures all time, helping users to position.

Our



Self Leveling

The image is always displayed correctly, without flipping

Other



No Self Leveling

The picture will flip as the camera flips



8. Cable Coil

New stable and strong coil structure with steel bearing inside, can easily release or coil the cable with less time and force.

How to release the cable:

Take out the cable from the holder, then pull the coil clockwise to release.

How to coil the cable:

Turn the cable counterclockwise to coil the cable back while using your other hand to hold and rotate the coil, then lock the cable in the holder.



9. Battery & Adapter

The battery is built into the control panel with a capacity of 4500mAh, and the screen displays the battery power status. **When the screen shows that the power is lower than 9V, please charge the battery.**

AC: 100-240V
OUTPUT: 12.6V-1000MA
Indicator Light
Red Color - Charging
Green Color - Fully Charge



The steps of charging are as follows:

- a. Take out the DC adapter from the box.
- b. Connect the DC adapter port to the charging port (on the control panel).
- c. Plug the DC adapter into 100-240V AC, when the indicator light shows red, it means it is charging.
- d. When the indicator light turns green, it means it is fully charged, the fully charging time is about 5-6 hours.

Note: To ensure a longer battery life, please charge it in time; otherwise, the battery may be damaged and cannot be recharged.

10. Device Installation

- a. Connect the side of the video cable to the port on the box and tighten.
- b. Connect another side of the video cable to the cable coil bearing and tighten it.
- c. Press the ON/OFF button on the control panel to turn on the battery, then press the power button on the screen to turn on the screen.

(As below pictures)

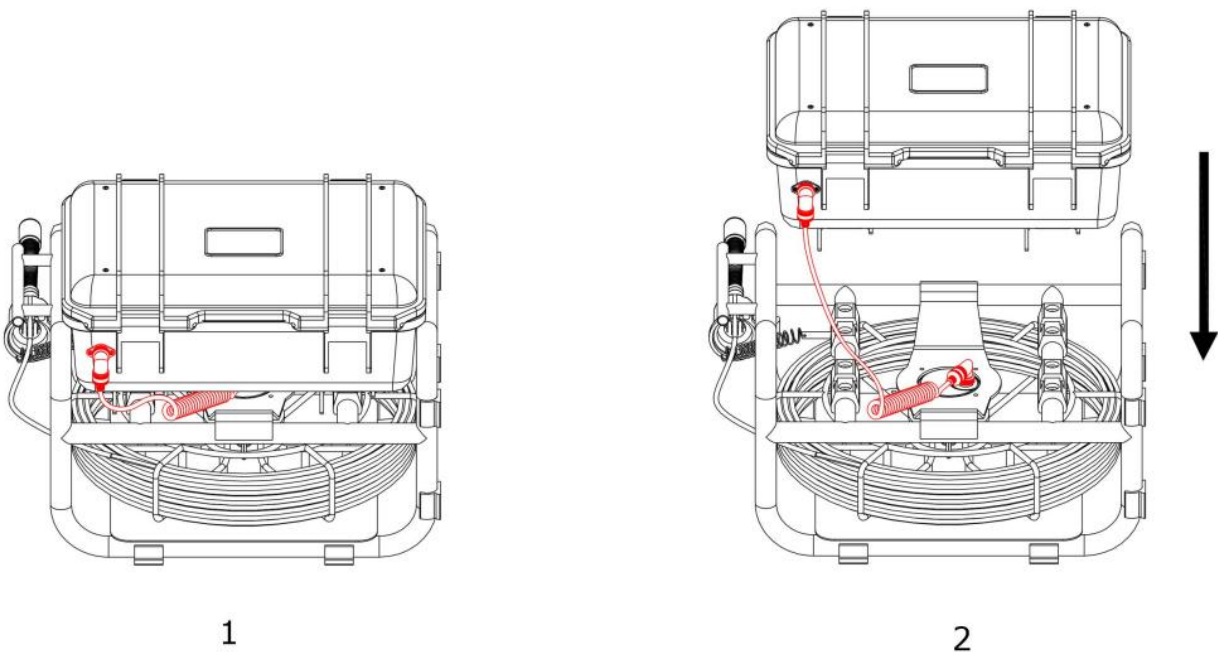



The following are the steps to install the pulley



1. find the mini screwdriver in the package



2. put the camera protective case on the camera head



3. screw the 3 white screw on the protective case, until it was fixed on the camera head



11. Structure & Accessories

- | | | |
|---------------------------------|--------------------|----------------------------|
| ① Plastic Box*1 | ② Metal Sunvisor*1 | ③ 16GB TF Card*1 |
| ④ 9-inch IPS Screen*1 | ⑤ Keyboard*1 | ⑥ Instruction*1 |
| ⑦ Lithium Battery*1 | ⑧ Metal Bracket*1 | ⑨ Fiberglass Cable*1 |
| ⑩ Handle*1 | ⑪ Camera Probe*1 | ⑫ 3.9in/99mm Pipe Pulley*1 |
| ⑬ 1.5in/38mm Protective Cover*1 | ⑭ DC Adapter*1 | ⑮ Screwdriver*1 |



12. Assemble & Disassemble Box

<1> Assemble steps:

- Align the bottom pad of the plastic box with the card slot on the bracket and install;
- Push to the left (backward) to fix the plastic box on the coil holder;

c. Insert the latch pin to prevent it from falling out.

<2> Disassembly steps:

- a. Pull out the latch pin;
- b. Push the box to the right and move out of the slot (as shown in the picture);
- c. Take out the plastic box.



13. Trouble & Troubleshooting

Trouble	Troubleshooting
No power	a. Check whether each interface is connected correctly; b. Check whether the battery is out of power, check the power display.
Can't be charged	a. Is the DC adapter plug-in correctly; b. Check if the indicator light of the DC adapter is on.
Power light stay on	Contact Sanyipace to replace the button plate
Can't record videos	a. Whether the TF card is inserted correctly; b. Insufficient TF card memory; c. Check whether the power is off during the recording process.
Recording videos in black and white color	Adjust the LED light button to the appropriate brightness, observe the screen display, and select a brightness that is clearer and more colorful.
Screen flashes	Please fully charge the device and confirm it again, the device doesn't have enough power to support its work.
Turn on the device but the screen freezes	Please take out the TF card and confirm it again, if you take it out and the device can work, please format the TF card on PC or use another TF card to work with the device.
Keyboard can't work	a. Confirm some keys do not work or if the whole keyboard does not work; b. Change another keyboard port to confirm it; c. Replace a computer keyboard to confirm it.
LED lights not working	a. Check whether the LED lights setting is turned on, by pressing the LED adjustment button on the panel or F6 to adjust the brightness; b. Tighten or loosen the camera probe slowly to check if it works; c. Contact Sanyipace to replace the camera probe or coil connector.

a. Coil Connector:

If you install the camera probe, it can work, but you pull out the cable about 15ft/5m and the screen shows 'no signal' in blue color, which means the coil connector is broken. Use a multimeter to test the circuit between the coil connector, if the circuit fails, please replace the coil connector.

Test the circuit between the ends of the coil connector with a multimeter



No signal, and the screen turns blue
(Suitable for **0.2in/5mm** diameter cable equipment)

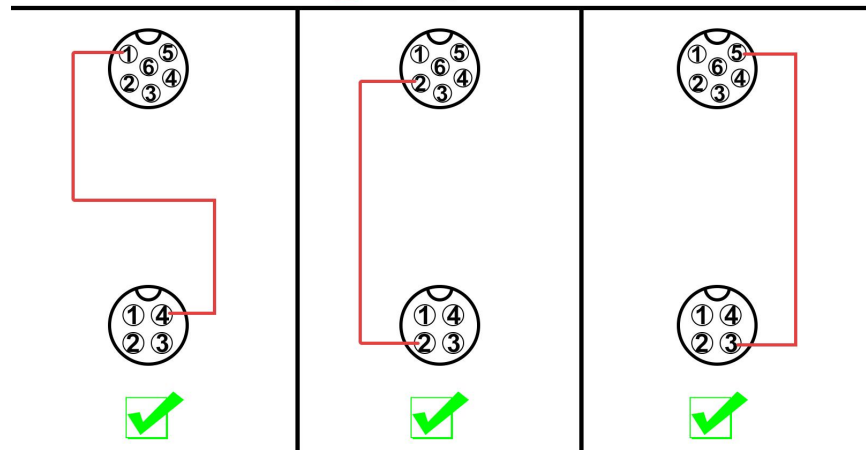

b. Coil Cable:

Use a multimeter to test the circuit between the coil cable and the cable connector (the part that connects the cable to the camera). If the circuit fails, please replace the coil cable.

Gold number 1 tested with circle 1

Gold number 4 tested with circle 2

Gold number 2 tested with circle 3

Gold number 3 tested with circle 4

No signal, and the screen turns blue

(Suitable for
0.2in/5mm
diameter cable
equipment)

Test the circuit between the ends of the coil cable with a multimeter

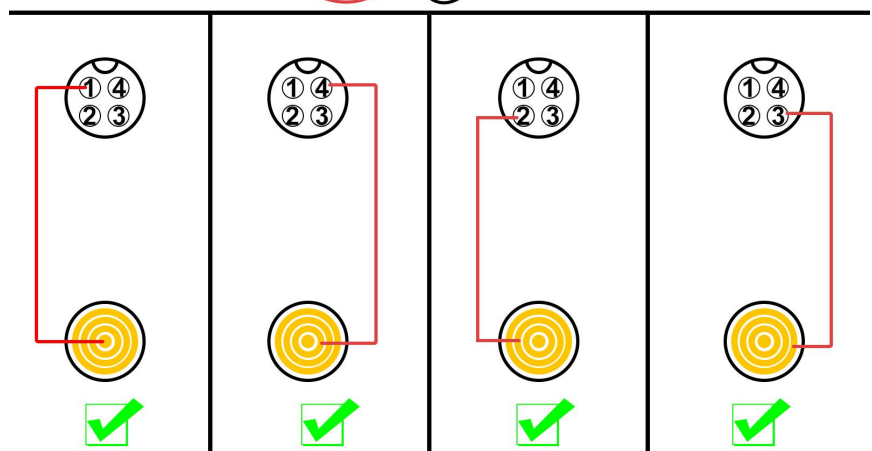

c. Spring Video Cable:

Use a multimeter to test the circuit between the spring video cable. If the circuit fails, please replace the video cable.

Test the circuit between the ends of the spring video cable with a multimeter

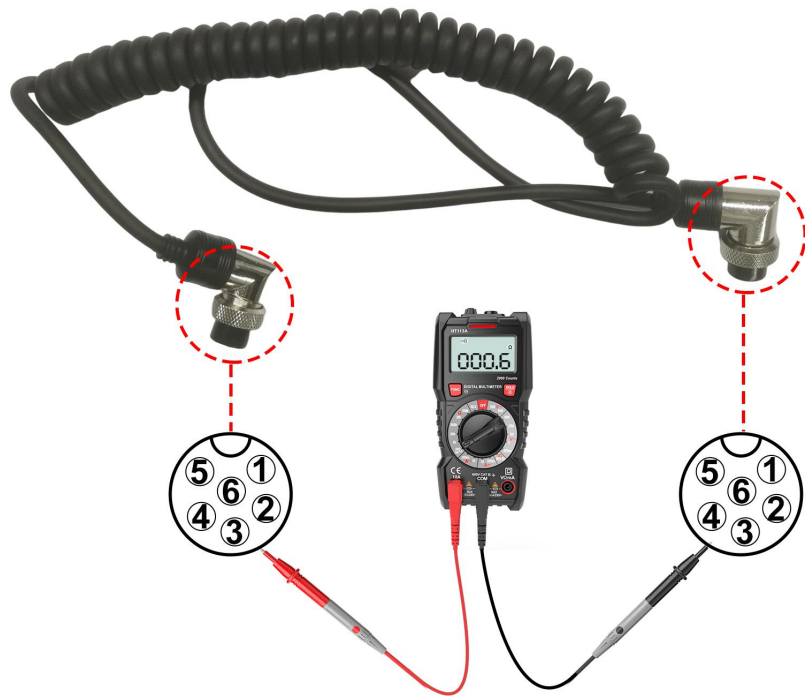

No signal, and the screen turns blue
(Suitable for **0.2in/5mm** diameter cable equipment)

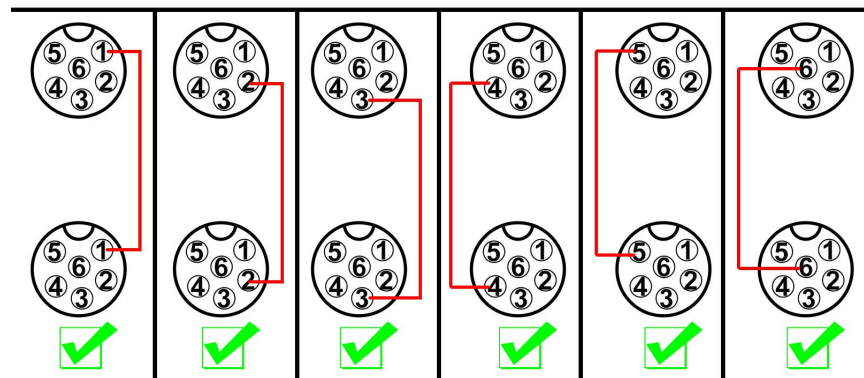

d. Camera Probe:

If you install the camera probe and the screen shows 'no signal' in blue color immediately, and the connectors and cables are good, means the camera probe is broken. Please confirm whether water ingress into the camera.

If it still can't work, please contact Sanyipace and describe the problem to let us deal with it.

a. Coil Connector:

If you install the camera probe, it can work, but you pull out the cable about 15ft/5m and the screen shows 'no signal' in blue color, which means the coil connector is broken. Use a multimeter to test the circuit between the coil connector, if the circuit fails, please replace the coil connector.

Test the circuit between the ends of the coil connector with a multimeter

No signal, and the screen turns blue
(Suitable for 0.28in/7mm diameter cable equipment)

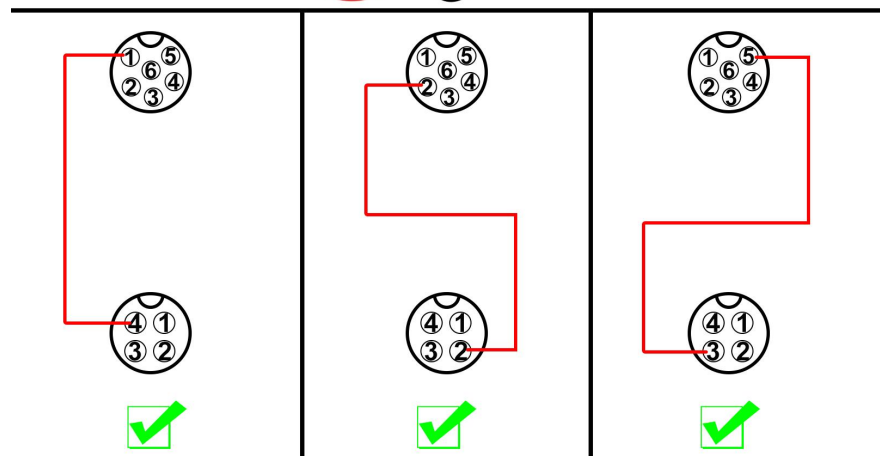

b. Coil Cable:

Use a multimeter to test the circuit between the coil cable and the cable connector (the part that connects the cable to the camera). If the circuit fails, please replace the coil cable.

Gold number 1 tested with circle 1

Gold number 4 tested with circle 2

Gold number 2 tested with circle 3

Gold number 3 tested with circle 4

Test the circuit between the ends of the coil cable with a multimeter

No signal, and the screen turns blue
(Suitable for **0.28in/7mm** diameter cable equipment)

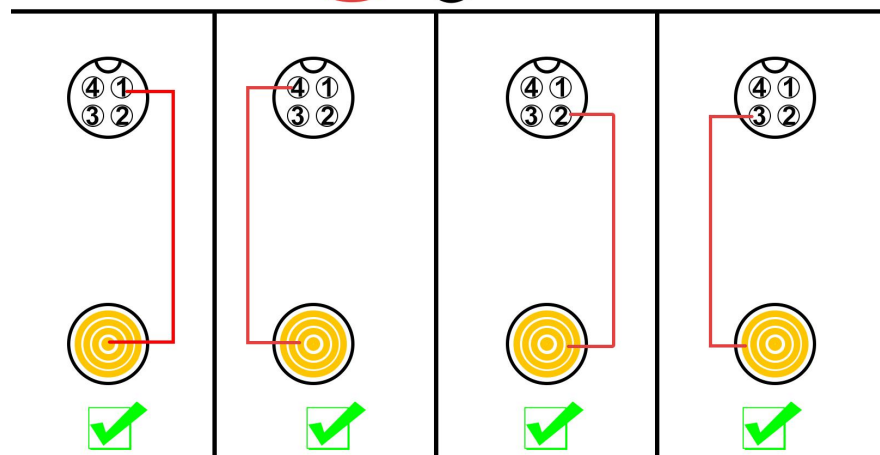

c. Spring Video Cable:

Use a multimeter to test the circuit between the spring video cable. If the circuit fails, please replace the video cable.

Test the circuit between the ends of the spring video cable with a multimeter

No signal, and the screen turns blue
(Suitable for
0.28in/7mm
diameter cable
equipment)

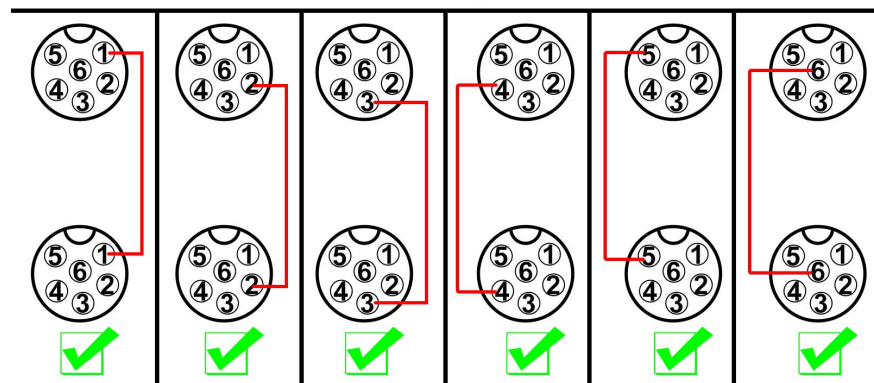
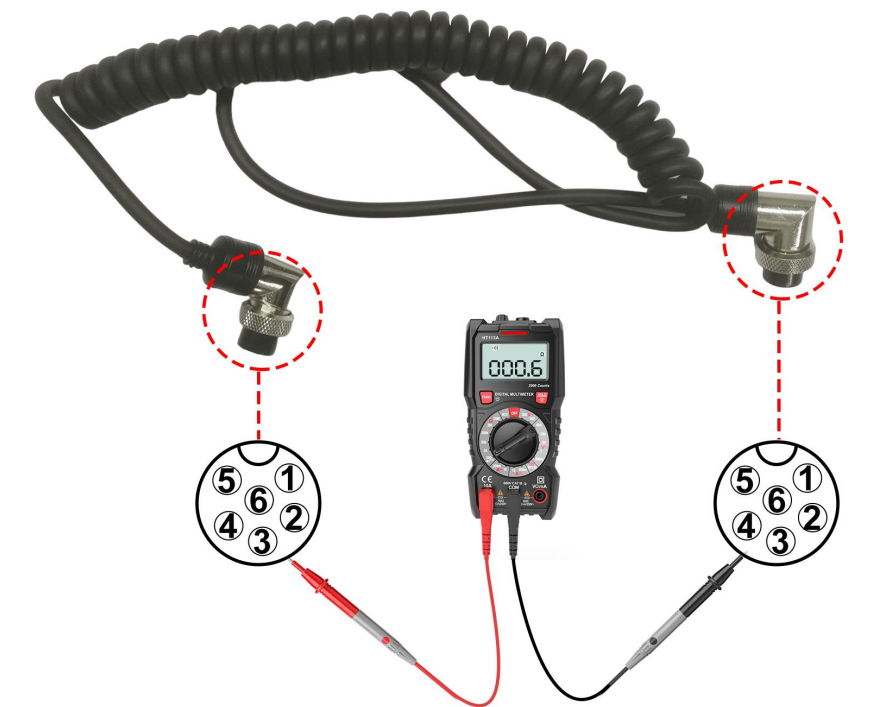

d. Camera Probe:

If you install the camera probe and the screen shows 'no signal' in blue color immediately, and the connectors and cables are good, means the camera probe is broken. Please confirm whether water ingress into the camera.

If it still can't work, please contact Sanypace and describe the problem to let us deal with it.

14. Warranty

We provide a one-year product quality warranty from the date of purchase and provide free lifetime product technical support. For normal faults or quality problems within the warranty period, we provide free replacement or repair services. For damage caused by manual operation, we will charge the cost of product parts for repair. Our technical support team is at your service 24 hours a day. If you encounter any problems during use, please feel free to contact us.

----Contact Us----

Purchase Sanyipace products, enjoy fast delivery and excellent service, please go to our official store on Amazon as below:

US: <https://www.amazon.com/sanyipace>

CA: <https://www.amazon.ca/sanyipace>

UK: <https://www.amazon.co.uk/sanyipace>

DE: <https://www.amazon.de/sanyipace>

FR: <https://www.amazon.fr/sanyipace>

IT: <https://www.amazon.it/sanyipace>

ES: <https://www.amazon.es/sanyipace>

Website: www.sanyipace.com

[Amazon Orders After-sale: support@sanyipace.com](mailto:support@sanyipace.com)

[Website Orders After-sale: service@sanyipace.com](mailto:service@sanyipace.com)

Facebook: Sanyipace

WhatsApp: +86 137 1399 9105