

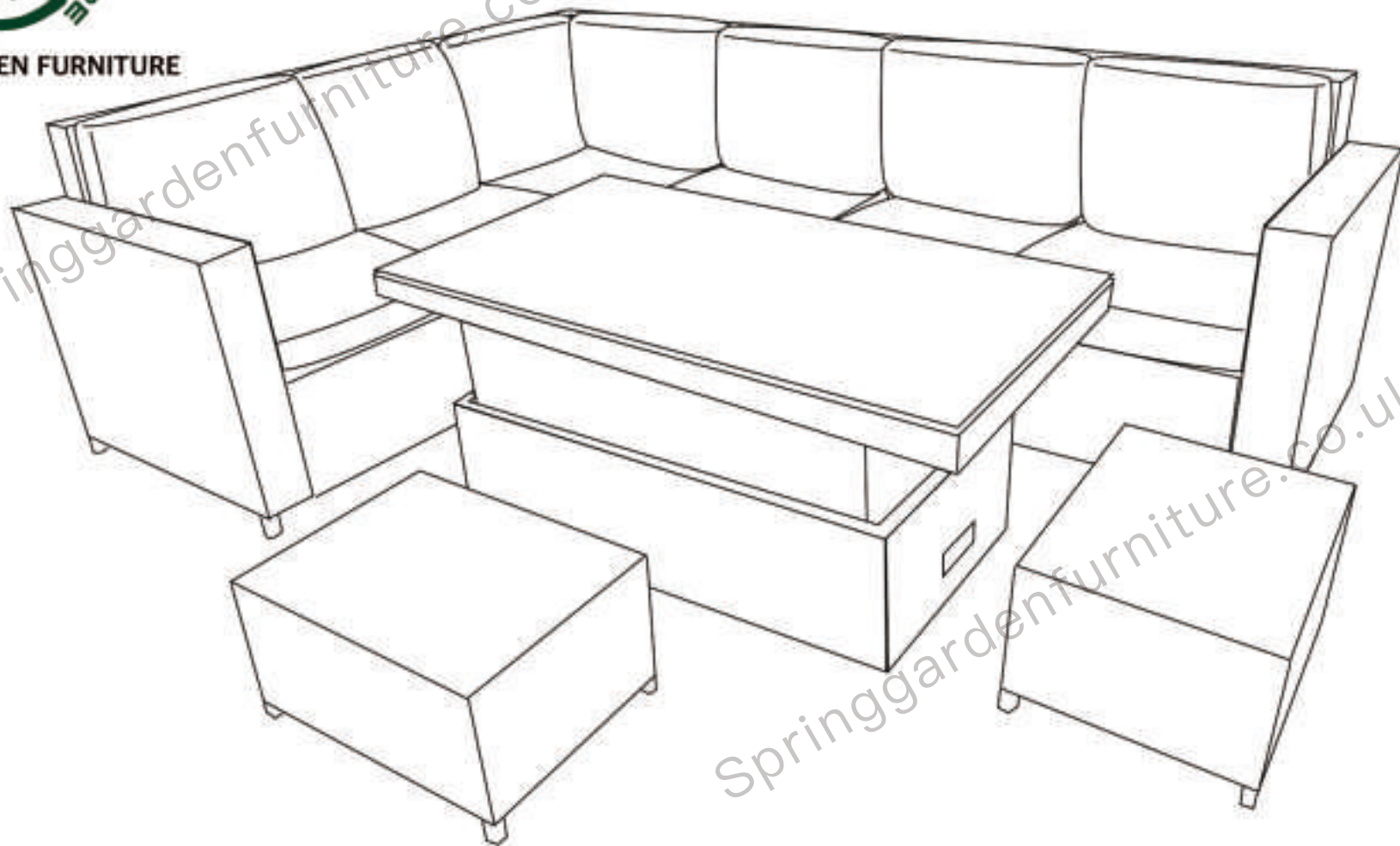

SPRING GARDEN FURNITURE

ASSEMBLY INSTRUCTION

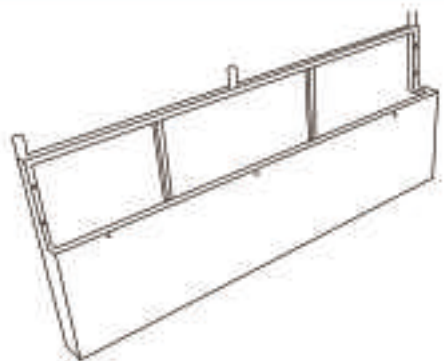



A-1 x1



A-2 x1

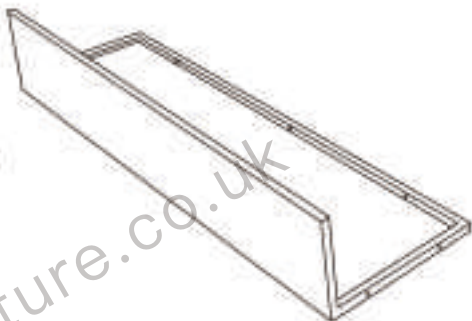

A-3 x1



A-4 x1



B-1 x1

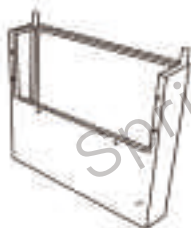

B-2 x1

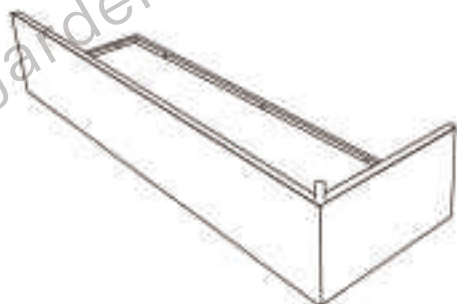

B-3 x1



C-1 x1

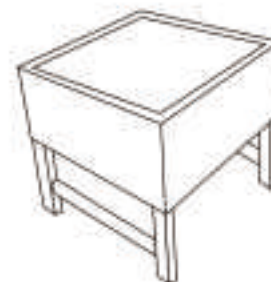

C-2 x1

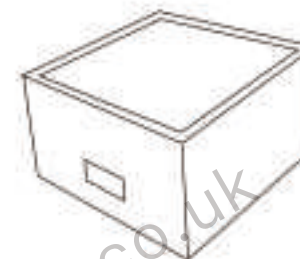

C-3 x1

PARTS LIST (Accessories)		
Part	Picture	Qty
N		42
P		42
T		1
U		2



C-4 x1

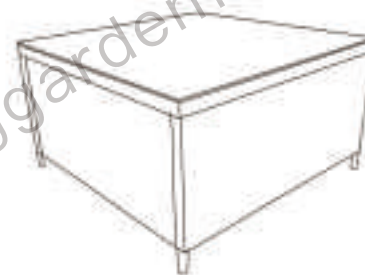

D-1 x2

▶ A

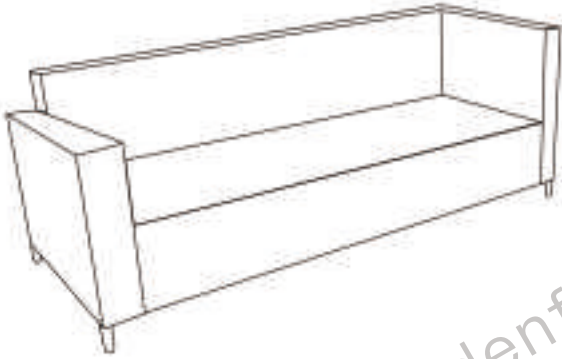

PARTS



A-1 x1



A-2 x1

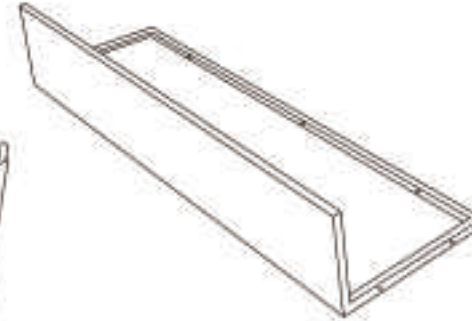

A-3 x1



A-4 x1

1

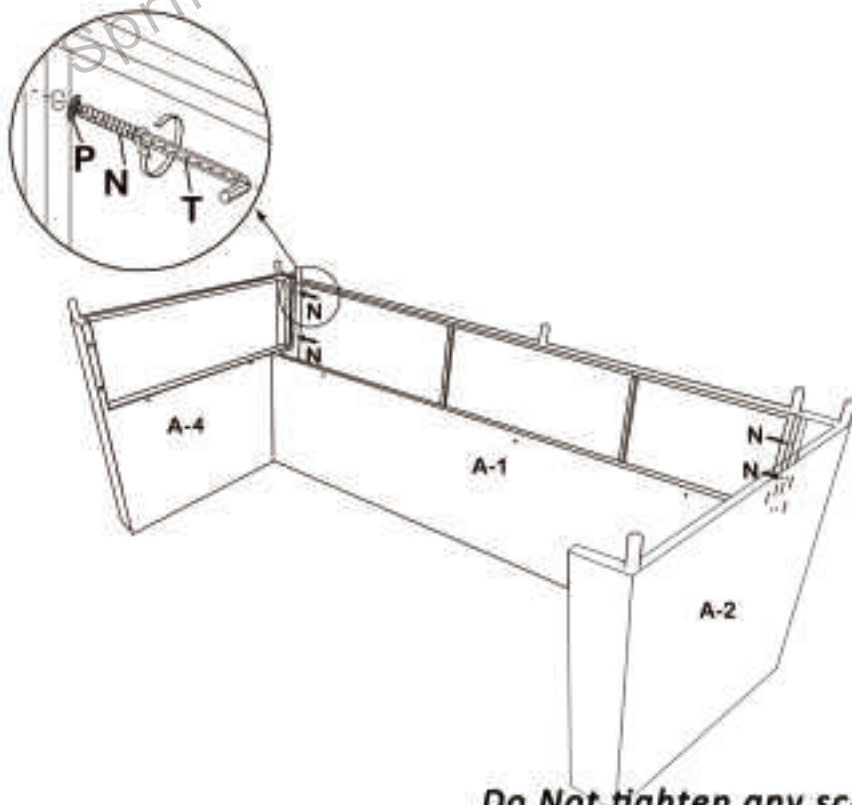

2

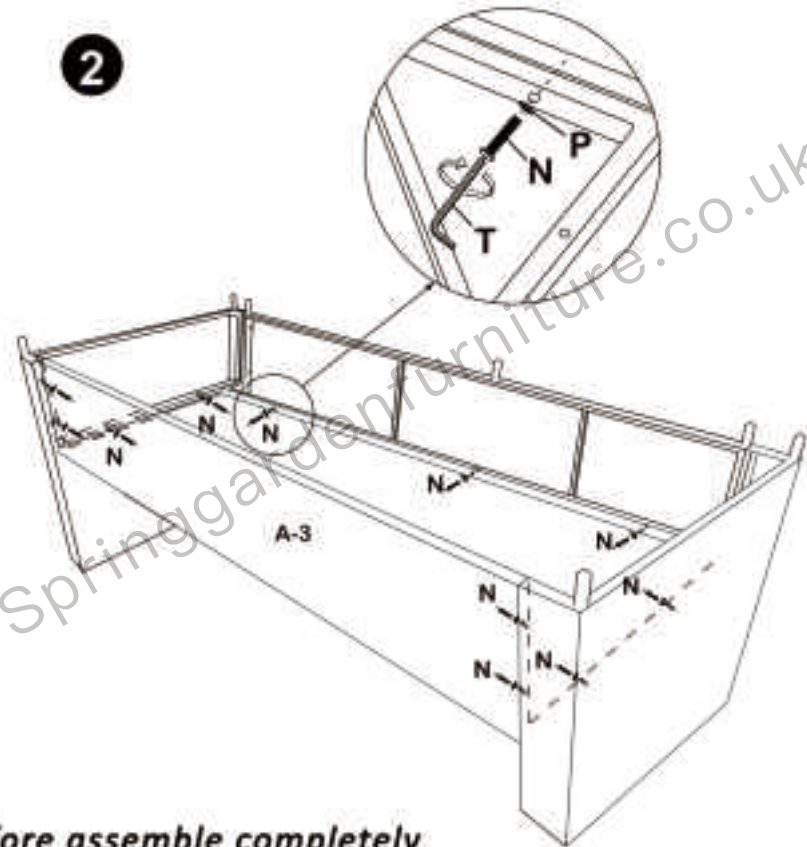

Do Not tighten any screws before assemble completely

▶ B

PARTS



B-1 x1



B-2 x1

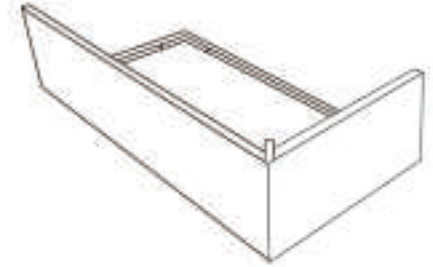

B-3 x1

1

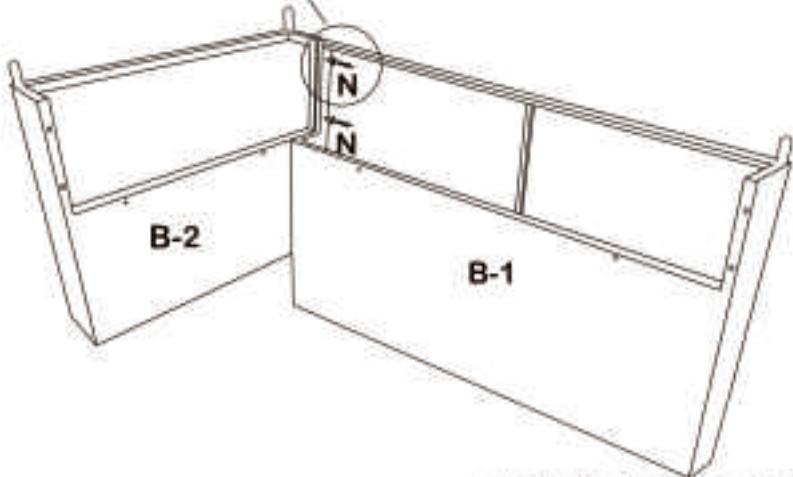
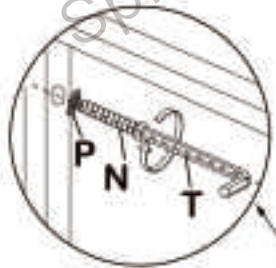

2

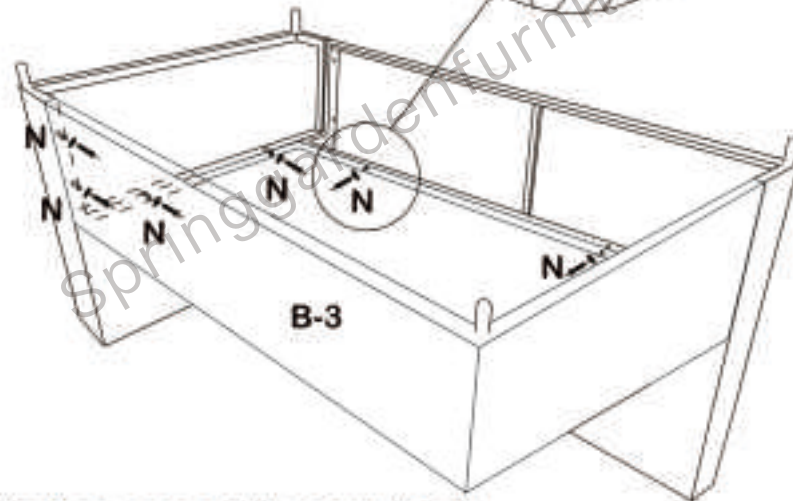
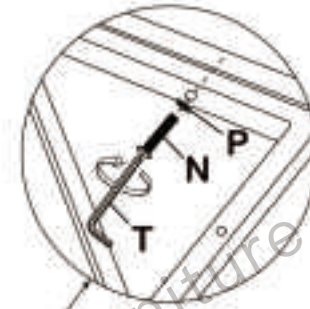

Do Not tighten any screws before assemble completely

▶ C

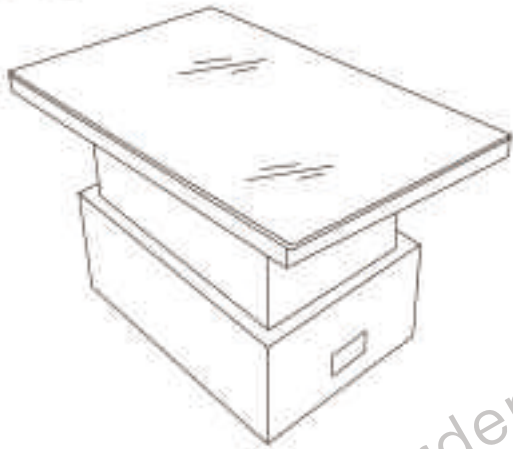

PARTS

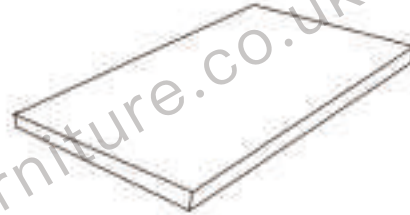

C-1 x1



C-2 x1

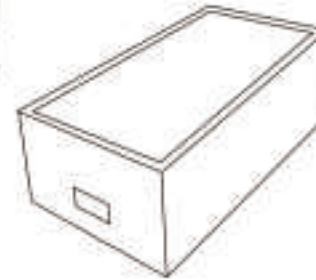

C-3 x1

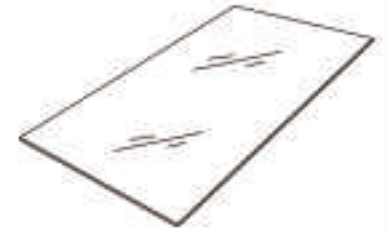

C-4 x1

1

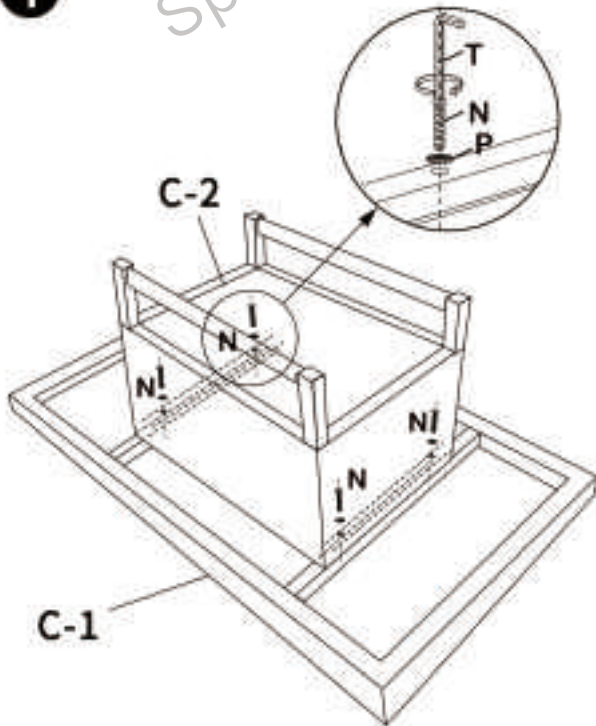

2

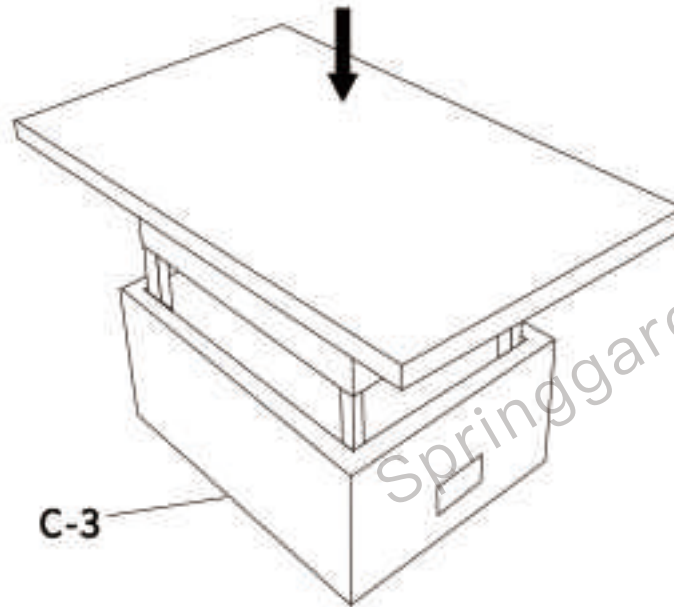

3

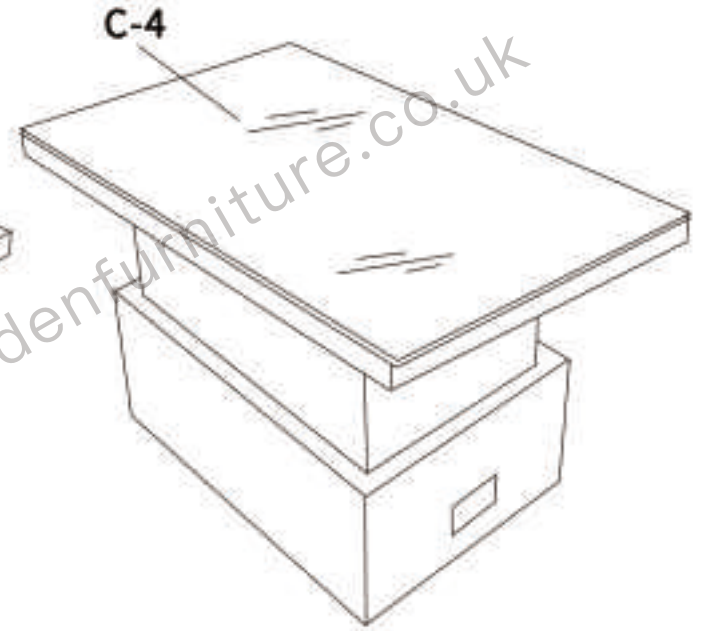

Do Not tighten any screws before assemble completely

► P.S.

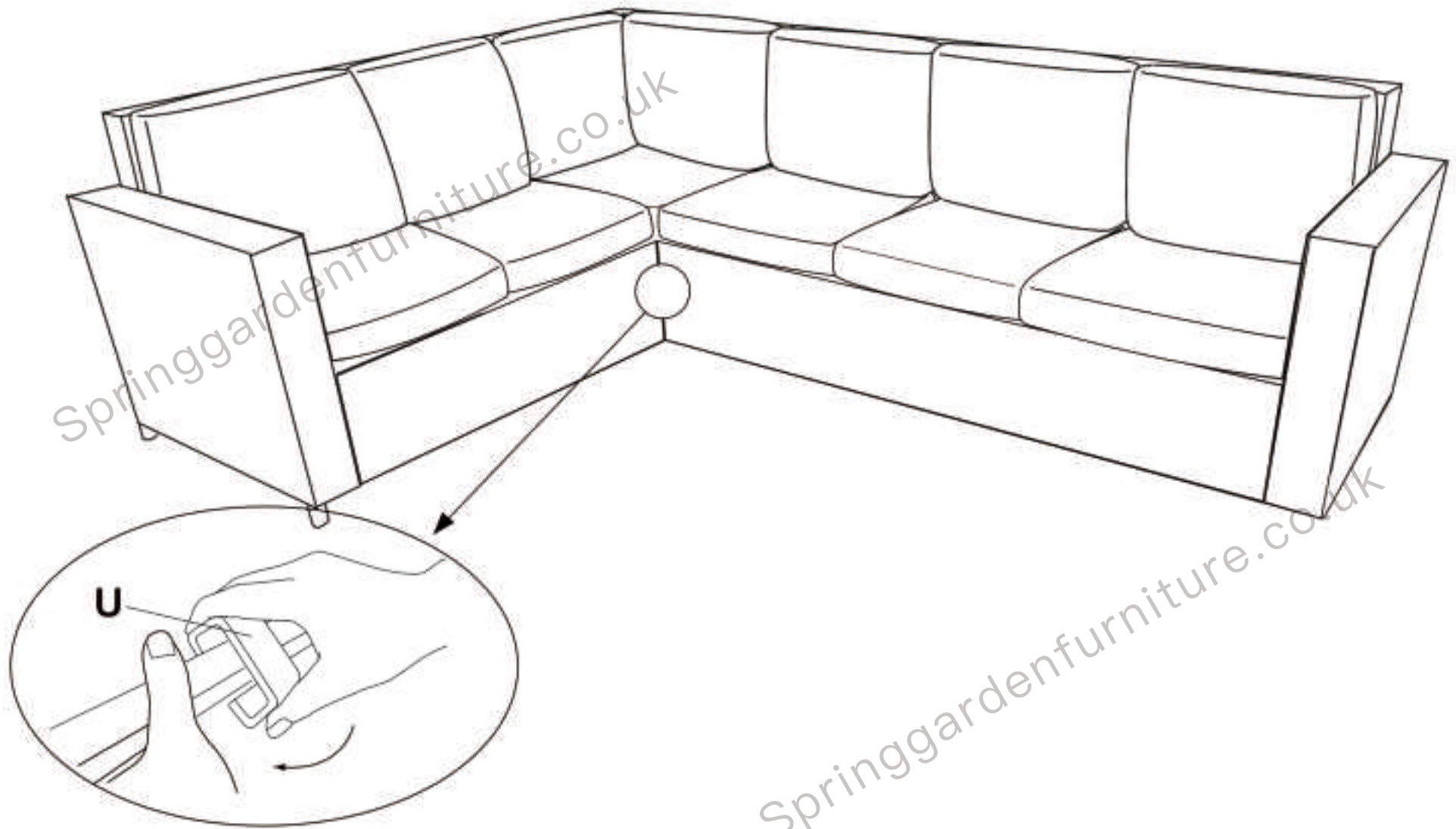

Furniture Fastener / Connector

Recommend 2 fasteners per two adjoining module.

Prevent modular or sectional wicker furniture from moving.